

# CardioCare 2000

## OPERATION MANUAL



Ver. 2.43

## Terms of Warranty

- This product is manufactured and passed through strict quality control and thorough inspection. Compensation standard concerning repair, replacement, refund of the product complies with “Consumer’s protection law” noticed by Ministry of Finance and Economy.
- EKG 2000 is warranted by Bionet Co., Ltd. to be free from defects in material and workmanship for one year(two years in Europe) from date of purchase.
- Warranty repair or replacement will be made by Bionet Service Center at no charge for warranty period if properly used under normal condition in accordance with the instructions for use.
- In the event of a malfunction or failure during warranty period, customer should inform Bionet Co., Ltd. of the model name, serial number, date of purchase and explanation of failure of the defective equipment.

## How to reach us ...

If you have any questions or comments relating to our products or purchasing, please contact the telephone numbers or E-mail below. You can talk to our sales people. Bionet always welcomes your enquiries. Please contact us.

---

### Contact Us

#### Bionet Co.,Ltd.

- Address: 5F, Shinsegae I&C Digital Center 61 Digital-ro 31 gil, Guro-gu, SEOUL 08375, REPUBLIC OF KOREA
- Tel: +82-2-6300-6410
- Fax: +82-2-6499-7789
- E-mail: [Sales@ebionet.com](mailto:Sales@ebionet.com)  
[Service@ebionet.com](mailto:Service@ebionet.com)
- URL: <http://www.ebionet.com>

※ In the event of a malfunction or failure, contact Service Dept. Of Bionet Co., Ltd. along with the model name, serial number, date of purchase and explanation of failure.

## Definition of Warning, Caution, Note

- For a special emphasis on agreement, terms are defined as listed below in operation manual. Users should operate the equipment according to all the Warning and Caution.
- Manufacturer or Sales agency takes no responsibility for any kind of damage or breakdown that is caused by misuse and failure to maintain the equipment. To inform that it may cause no harm in life but lead to injury against the “Caution” sign.

<b>Warning</b>
To inform that it may cause serious injury or death to the patient, property damage, material losses against the “Warning” sign.

<b>Caution</b>
To inform that it may cause no harm in life but lead to injury against the “Caution” sign.

<b>Note</b>
To inform that it is not dangerous but important for proper installation, operation, and maintenance of the equipment.

## Service Requirements

Refer servicing for equipment to Bionet Co., Ltd authorized service personnel. Any attempt to repair equipment under warranty will void that warranty.

It is the responsibility of users requiring service to report the need for service to Bionet Co., Ltd., or to one of their authorized agents.







Failure on the part of the responsible individual, hospital, or institution using this equipment to implement a satisfactory maintenance schedule may cause undue equipment failure and possible health hazards.

If there are any problems with the equipment, please follow the steps below:

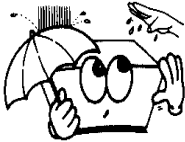
- Contact the Bionet Oversea Service Department immediately. After gathering the model name, Serial Number, date of purchase, and description of the problem contact Bionet with the information shown below.
- Try to solve the problem over the phone with the service department personnel. If the problem cannot be solved over the phone, the service personnel can come and fix the problem directly.
- Bionet or local distributor will make available on request circuit diagrams, component part lists, descriptions, calibration instructions or other information which will assist your appropriately qualified technical personnel to repair those parts of equipment which are designated by Bionet as repairable.

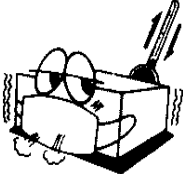
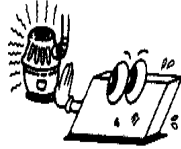
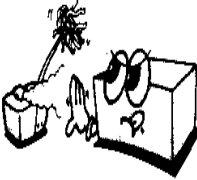
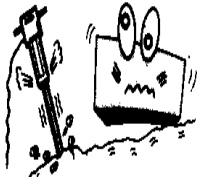
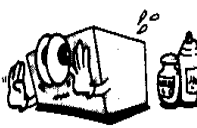
## General Precaution on Environment

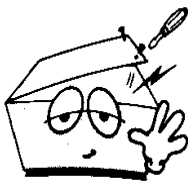
- Do not keep or operate the equipment in the environment listed below.

	<p>Avoid placing in an area exposed to moist. Do not touch the equipment with wet hand.</p>		<p>Avoid exposure to direct sunlight</p>
	<p>Avoid placing in an area where there is a high variation of temperature. Operating temperature ranges from 10°C to 40°C. Operating humidity ranges from 30% to 85%.</p>		<p>Avoid in the vicinity of Electric heater</p>
	<p>Avoid placing in an area where there is an excessive humidity rise or ventilation problem.</p>		<p>Avoid placing in an area where there is an excessive shock or vibration.</p>
	<p>Avoid placing in an area where chemicals are stored or where there is danger of gas leakage.</p>		<p>Avoid being inserted dust and especially metal material into the equipment</p>
	<p>Do not disjoint or disassemble the equipment. Bionet Co., Ltd. takes no responsibility for it</p>		<p>Power off when the equipment is not fully installed. Otherwise, equipment could be damaged.</p>

## General Precaution on Electric Safety

Check the items listed below before operating the equipment.

- Be sure that AC power supply line is appropriate to use. (100 - 240V AC).
- Be sure that the entire connection cable of the system is properly and firmly fixed.
- Be sure that the equipment is completely grounded. (Otherwise, noise could result.)

### Note

The equipment should not be placed in the vicinity of electric generator, X-ray, broadcasting apparatus to eliminate the electric noise during operation. Otherwise, it may cause incorrect result.

Self-power line and stable grounding is important for EKG 2000.

To use same power source with other electric instruments may cause incorrect result.

### Note

EKG 2000 is classified as listed below ;

- This equipment conforms to Class I, Type-BF. The equipment should be grounded to protect the patient from electrical shock.
- Do not use the equipment in the vicinity of flammable anesthetics and solvents.
- The equipment conforms to Class I according to IEC/EN 60601-1 (Safety of Electric Medical Equipment)

This equipment conforms to Class A according to IEC/EN 60601-1-2 (Electromagnetic Compatibility Requirements)

### Note

Diagnosis has to be confirmed by the doctor.

### Note









Accessory equipment connected to the analog and digital interfaces must be certified according to the respective IEC standards ( e.g. IEC 950 for data processing equipment and IEC 601-1 for medical equipment ). Furthermore all configurations shall comply with the system standard EN 60601-1-1:1993.

Everybody who connects additional equipment to the signal input part or signal output part configures a medical system, and is therefore responsible that the system complies with the requirements of the system standard IEC 601-1-1:1993. If in doubt, consult the technical service department or your local representative. Diagnosis has to be confirmed by the doctor.

## Safety Symbols

- The International Electrotechnical Commission (IEC) has established a set of symbols for medical electronic equipment which classify a connection or warn of any potential hazards. The classifications and symbols are shown below.

### Save these instructions.

Symbols	contents
	Isolated patient connection. (IEC 601-1-Type BF)
	Device part switched off.
	Device part switched on.
	This symbol identifies a safety note. Ensure you understand the function of this control before using it. Control function is described in the appropriate operation manual.
	Conductor provides a connection between equipment and the potential equalization bar of the electrical installation
	External Signal IN/OUT Port
	EKG Signal Input Port
<b>The following symbols are used inside the system :</b>	
	Identifies the point where the system safety ground is fastened to the chassis. Protective earth connected to conductive parts of Class I equipment for safety purposes.



# Table of Contents

<b>Table of Contents .....</b>	<b>9</b>
<b>Chapter 1. General Information .....</b>	<b>11</b>
<b>1) Introduction.....</b>	<b>12</b>
<b>2) Features of the equipment.....</b>	<b>12</b>
<b>3) Equipment description .....</b>	<b>13</b>
Standard accessories.....	13
Options.....	13
Main Unit .....	14
LCD Panel.....	17
Control panel.....	18
AC Power .....	20
<b>4) System Installation .....</b>	<b>21</b>
Installation precautions.....	21
Power cable connection .....	21
Patient Cable Connection.....	22
Recording paper installation.....	22
<b>5) Menu structure.....</b>	<b>23</b>
<b>6) System Setting.....</b>	<b>24</b>
Initial setting .....	24
Date and time .....	25
User identification.....	26
Language .....	27
<b>Chapter 2. Preparation for ECGs recording .....</b>	<b>28</b>
<b>1) Electrode positions .....</b>	<b>29</b>
<b>2) Electrode connection .....</b>	<b>30</b>
Check before connection.....	30
Connecting the Electrodes .....	30
Connecting the Patient Cable.....	30
Lead-Off troubleshooting.....	30

<b>Chapter 3. Recording of ECGs.....</b>	<b>31</b>
<b>1) Introduction.....</b>	<b>32</b>
<b>2) Basic setting .....</b>	<b>33</b>
General information.....	33
Signal Level Setting.....	33
Display speed setting .....	33
Filter Setting .....	34
Channel form setting .....	35
Rhythm channel setting.....	35
Grid setting.....	36
Monitoring form setting.....	37
Monitoring channel setting .....	38
Diagnosis on/off setting .....	39
Enter Patient Data .....	40
<b>3) Monitor mode output.....</b>	<b>46</b>
Output method .....	46
Output form .....	46
<b>4) Record mode output.....</b>	<b>47</b>
10 seconds ECG recording .....	47
60 seconds ECG recording .....	48
Output form .....	49
<b>5) Copy mode output.....</b>	<b>54</b>
<b>Chapter 4. System control.....</b>	<b>56</b>
<b>1) Maintenance and Cleaning.....</b>	<b>57</b>
<b>2) Regular Inspection .....</b>	<b>58</b>
<b>3) Troubleshooting .....</b>	<b>58</b>
<b>Chapter 5. Specification .....</b>	<b>59</b>

## **Chapter 1. General Information**

### **1) Introduction**

### **2) Features of the equipment**

### **3) Equipment description**

Standard Accessories

Options

Main Unit

LCD Panel

Control Panel

AC Power

### **4) System Installation**

### **5) Menu Structure**

### **6) System Settings**

Initial Setting

Date and Time

User Identification

Language

## 1) Introduction

EKG2000 is 12ch ECGs equipment which measure and record ECGs of the patient.

EKG2000 provides users with ECGs record of the patient, measurement parameters for diagnosis and auto analysis.

Patient information and user identification printed along with ECGs on the output report is effective for hospital chart control.

For convenient operation, ECGs can be measured and recorded by pressing short key. Then, ECGs is printed in A4 sized report form after applying filter, calculating the measurement parameter and auto analysis.

In addition to an AC power, it can be continuously operated with a built-in rechargeable battery. This enables the EKG2000 to be used in an ambulance, in a visit to patients or during patient transportation.

## 2) Features of the equipment

12 channel ECGs is printed in a various channel form of 3ch+1rhy, 6ch+1rhy, 12ch rhy, 60s 1rhy in A4 sized report form.

1. 1 channel rhythm is recorded for 60 seconds and printed in A4 sized report form.
2. 12 channel rhythms are printed simultaneously and continuously in real time..
3. Measurement parameters such as heart rate, PR interval, QRS duration, QT/QTc, P-R-T axes required for diagnosis is printed along with ECGs on the output report after calculating automatically.
4. Auto analysis enables 75 diagnosis.
5. For convenient diagnosis, ECGs can be printed after changing system setting such as filter, signal level, printing speed, channel form, rhythm channel of the recorded ECG data.
6. Easy to carry with built-in rechargeable battery.
7. Patient information and user identification can be entered and printed along with ECGs for effective hospital chart control.

### Indications

The ECG has proven to be among the most useful diagnostic tests in clinical medicine. The ECG is now routine in the evaluation of patients with implanted defibrillators and pacemakers, as well as to detect myocardial injury, ischemia, and the presence of prior infarction as well. In addition to its usefulness in ischemic coronary disease, the ECG, in conjunction with ambulatory ECG monitoring, is of particular use in the diagnosis of disorders of the cardiac rhythm and the evaluation of syncope.

### Contraindications

No absolute contraindications to performing an electrocardiogram, other than patient refusal, exist. Some patients may have allergies, or more commonly, sensitivities to the adhesive used to affix the leads; in these cases, hypoallergenic alternatives are available from various manufacturers.

## 3) Equipment description

EKG 2000 is composed of the items as follows.

Checks out all the listed accessories are available after opening the packaging box. Also, check if the main unit and accessories are damaged or harmed.

### Standard accessories

- ① EKG2000 Main unit
- ② Patient cable (1 EA)
- ③ Limb electrode (1 SET)
- ④ Chest electrode(1SET)
- ⑤ Operation manual (1EA)
- ⑥ ECG Gel (1 EA)
- ⑦ Recording paper (1 EA)
- ⑧ AC power cable (1 EA)
- ⑨ Diagnosis guide book (1EA)

### Options

- ① Cart
- ② Hanger
- ③ Built-in Battery

## Main Unit

### ■ Front View

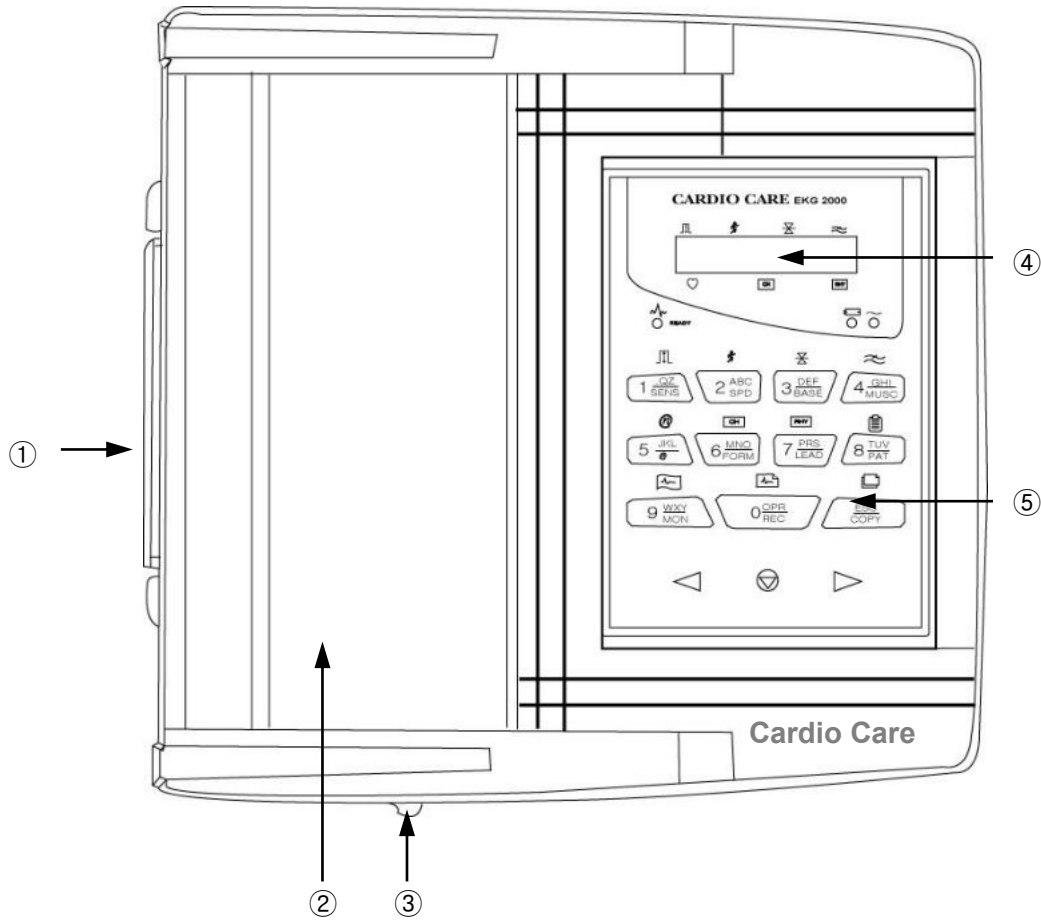

- ① Knob
- ② Printer door
- ③ Printer door release button
- ④ LCD
- ⑤ Control panel

## ■ Rear view

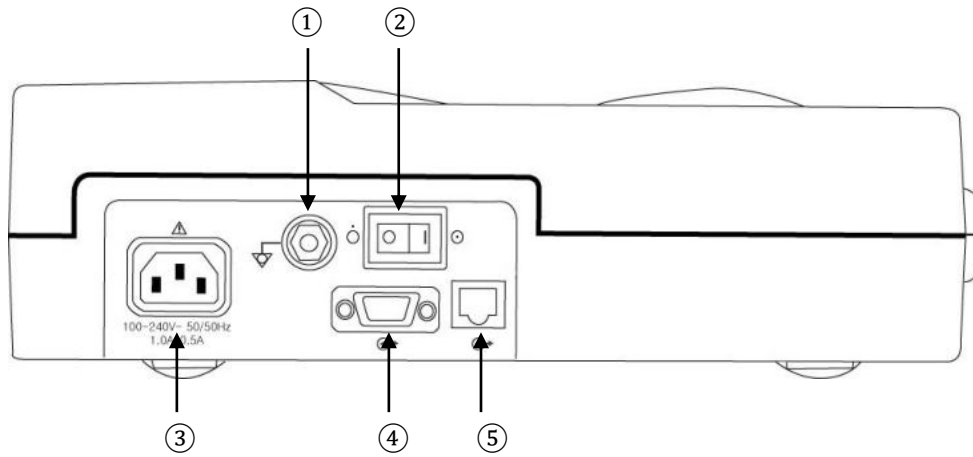

- ① Potential equalization stud
- ② Main power switch
- ③ AC power socket
- ④ RS-232C SERIAL port
- ⑤ LAN port

## ■ Left side view

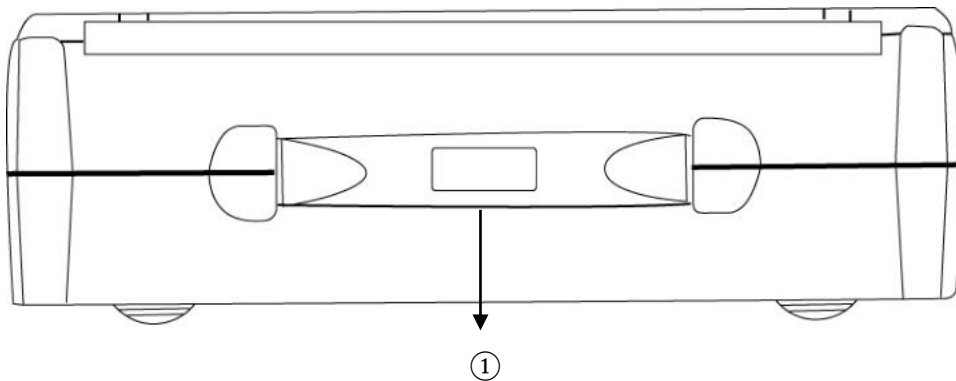

- ① Handle

## ■ Right side view

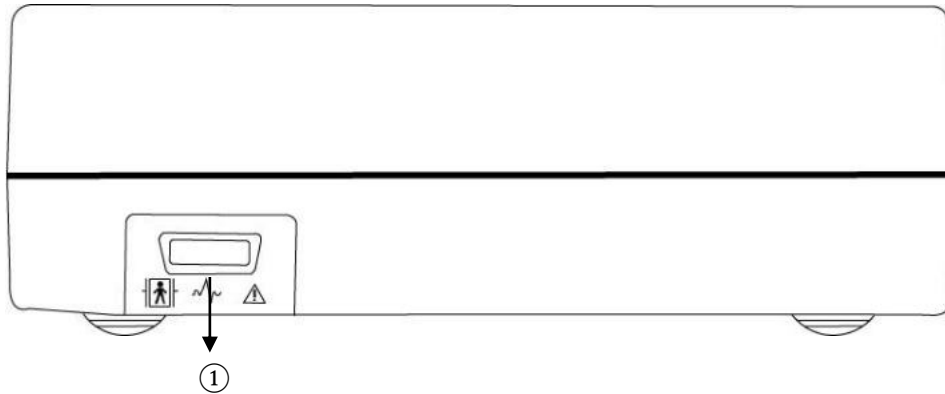

① Patient cable connection port

### Warning

Do NOT disassemble the case of the equipment to avoid the electric shock. Refer servicing to Bionet Co., Ltd qualified personnel or your local authorized dealer.



## LCD Panel

LCD panel displays system setting status after indicating the version of the system and manufacturer name for 2 seconds when power is turned on.

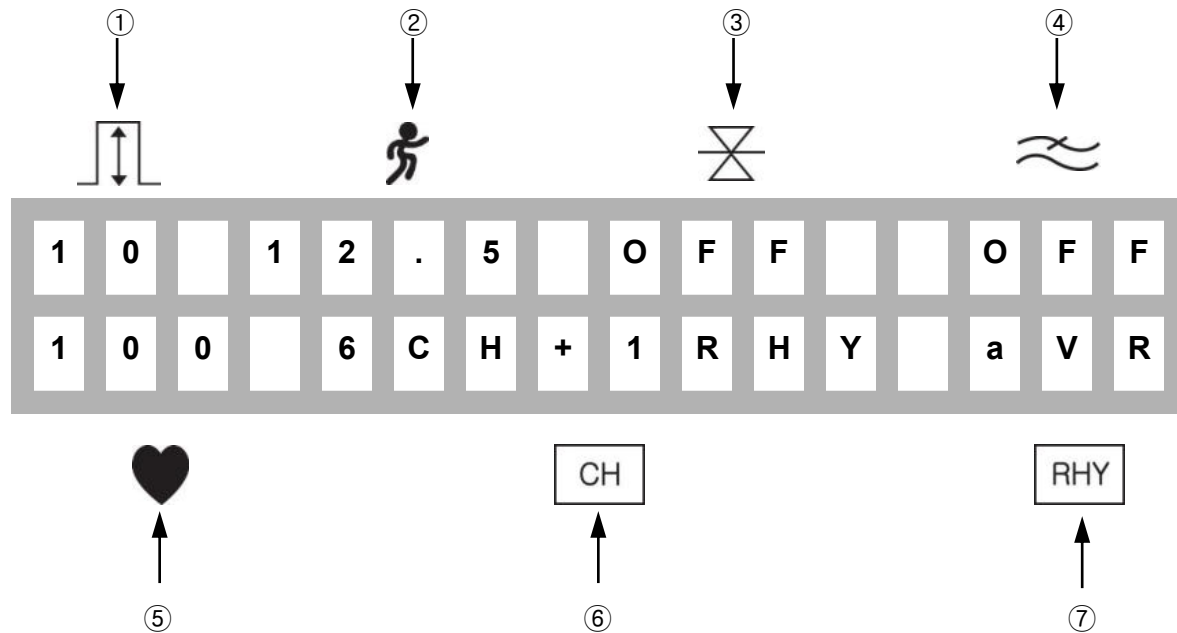

Displayed items on the LCD are as follows.







- ① Display ECG signal level out of 5, 10, 20, aut (Auto Gain)
- ② Display printing speed out of 12.5, 25, 50
- ③ Display base line filter setting on or off
- ④ Display EMG filter setting on or off
- ⑤ Display heart rate
- ⑥ Display channel form of the output report out of 3ch+1rhy, 6ch+1rhy, 12ch rhy, 60s 1rhy.
- ⑦ Display rhythm channel setting out of I, II, III, aVR, aVL, aVF, V1, V2, V3, V4, V5, V6..

## Control panel











### ■ Indicator lamp

	<p>Indicate the lead connection status.</p> <p>If LED is illuminated green, connection status is good .</p> <p>If LED is off, connection status is bad.</p> <p>In this case, check off which one of lead connection is in lead-off status through monitor mode output.</p> <p>Caution: Start printing when LED is illuminated green.</p> <p>Indicate the battery capacity status: Green and Red colors are used to display 2 different statuses.</p>
	<p>The battery indicator is red when the device is operational without having an A/C power supply. When an A/C power is supplied, the battery indicator will be either red or green depending on the charge level. No color will be shown, if there is no battery installed in the device.</p>
	<p>Indicate AC power is operated if LED is illuminated green and not in use if LED is off.</p>

### ■ Short keys

	<p>Select signal level(mm/mV) out of 5, 10, 20, aut (I-aVF:10, V1-V6:5 )</p>
	<p>Select printing speed(mm/sec) out of 12.5, 25, 50</p>
	<p>Select on or off whether or not to activate the filter that eliminates base line drift</p>
	<p>Select on or off whether or not to activate the filter that eliminates EMG. ECG signal can be distorted by applying this filter.</p>

# CardioCare2000 Operation Manual

	This key is excepted to use when network function is added ahead.
	Select channel form of the output report out of 3ch+1rhy, 6ch+1rhy, 12ch rhy, 60s 1rhy
	Select rhythm channel
	Call up the menu to enter patient ID, name, age, sex, height, weight
	Display real-time ECGs from the patient continuously or monitoring the patient ECGs for long time,
	Record ECGs for 10 seconds by pressing key and prints in A4 sized report form after calculating the measurement parameter of the recorded ECGs
	Print the same report as previously printed one in record mode or prints after changing system setting such as filter, signal level, output speed, channel form, rhythm channel of previously recorded ECGs data in record mode.
	Exit during printing or recording of ECGs. Except that, call up the menu or select menu.
	Move the selected focus to the left in menu mode
	Move the selected focus to the right in menu mode

## AC Power

When AC power is supplied to the equipment, AC power indicator lamp at the front side is illuminated green and battery is being charged automatically.

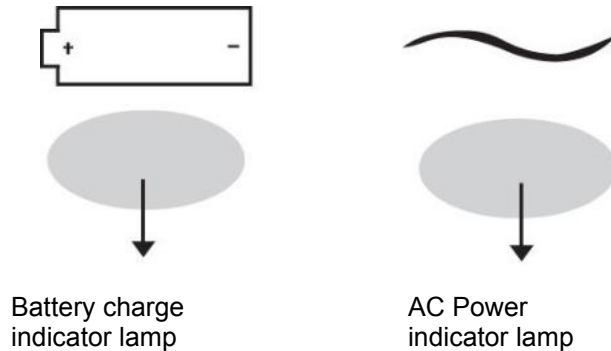

If no battery is installed, battery indicator lamp will be off. Once a battery is plugged in and the device is powered on, it will change its power mode to supply power to the battery. If the device is running on the power from the battery, battery charge indicator lamp will light up red color. If the battery is running low on power, three continuous buzzer alarms will sound. If this occurs, turn off the device and connect the A/C power before turning the device back on.

- Required time for charging : more than 4 hours
- Continuous battery operating time : 1 hour

### Caution

For the protection of environment, do NOT throw wasted battery away. Please inquire at the biomedical engineering lab of the hospital and dispose according to the appropriate procedure to the authorized place(according to national regulations).

## 4) System Installation

### Installation precautions

When installing EKG2000 system, take the following precautions.

- The equipment should be operated within 10~40℃ temperature and 30~85%humidity.
- Check the power cord connection and probe should be handled with care.
- Do not plug several power cords in one electric outlet.
- Main unit should be installed on an even, level place.
- Check that the equipment is properly grounded to avoid noise.
- The entire system settings are stored on the internal memory even when system power is turned off and on again
- Avoid excessive shock or vibration that could result in equipment damage.
- Avoid using in the vicinity of dust and flammable material.

### Power cable connection

The equipment operates when the power cable end connect into the EKG2000 power cord. Replace the fuse of the equipment if power is not turned on despite that power cord is connected and battery power is in normal condition. Contact service dept. of Bionet Co.,Ltd if the equipment is not operated after replacing fuse.

#### Caution

For the continuous protection against the fire hazard, the fuse must be changed to the same type and rate of fuse by technician (T3A250V).  
For the protection of environment, do NOT throw wasted fuse away in a dangerous place for the example fire hazard

## Patient Cable Connection

- Connect the patient cable into the connection port at the rear of the equipment.
- Connect the limb electrodes to the N, F, R, L lead and chest electrodes to C1, C2, C3, C4, C5, C6 of the patient cable.

## Recording paper installation

- Printer door open if printer release button at the side of EKG 2000 is pushed in the right. Place the recording paper with the signal-recording side up and push back to close.

## 5) Menu structure

EKG2000 system provides 3 basic modes with preparation mode, output mode, and menu mode. Preparation mode is an initial condition when system starts operating. LCD displays system settings and heart rate.

In preparation mode, system setting can be changed by pressing each short keys SENS, SPD, BASE, MUSC, FORM, LEAD, PAT, MON, REC, COPY of the control panel.  key calls up the menu mode.

Output mode is to activate print operation in the preparation mode with pressing short keys MON, REC, COPY. Only with MON, REC, COPY,  key of the control panel stops printing in output mode.

Menu mode is activated by pressing  key in preparation mode and following window displays on the LCD.

PAT FLT PRN SYS
< PATient Info >

First line indicates menu selection and second line indicates an explanation of the menu items or selected value.

Press  key to move the focus.

Press  key to select the focused menu items.

Press ESC key of control panel to move the menu above.

Menu structure is as follows;

PAT	< PATient Info > Enter the patient information including patient ID, name, age, sex, height, weight
FLT	< FiLTer setup > Select and adjust filter setting of base line drift filter, EMG filter, ac filter, low pass filter.
PRN	< PriNter setup > Select and adjust signal level, printing speed, grid, numbers of channel, rhythm channel select, test printout
SYS	< SYStem setup > Enter system setting including date, time, hospital name, user name.

## 6) System Setting

### Initial setting

Press 1key of the control panel for 3 seconds to initialize the system at the factory preset. After 3 seconds, following window message appears on the LCD for 1sec and system sets to initialize.

* FACTORY MODE *
initialize

Initialized details are as follows;

Date(DATE)	2000-00-00 (fixed)
Time(TIME)	00-00-00
Signal level(SENS)	10mm/mV
Display speed(SPD)	25mm/s
Grid(GRID)	Off
Channel form(FORM)	6ch+1rhy
Rhythm lead(LEAD)	II
Base line filter(BASE)	On
EMG filer(MUSC)	Off
AC noise filter(AC)	60hz
Low pass filter	40hz



## Date and time

To set the present date of EKG2000, move the menu to \* **DATE SETUP** \* as following steps;

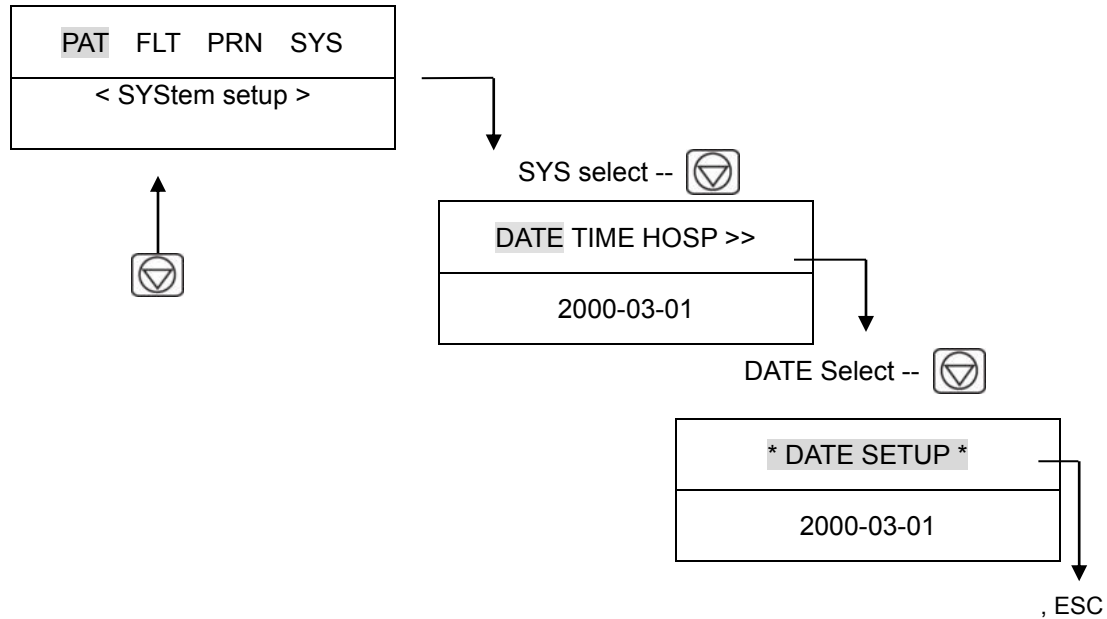

Number is entered by pressing 0,..., 9 numeric key in the current cursor position and cursor automatically moves to the right. To exit the date setting press  key or ESC key that moves to the menu above.

To set the time of EKG2000, move the menu to SYS → TIME → \* TIME SETUP \* as shown above. Then enter the time in the same way date is entered.

## User identification

User identification is to enter the hospital name and doctor name that operates the system. To enter the hospital name, move the menu to \* **ENTER HOSP.** \* as following steps.

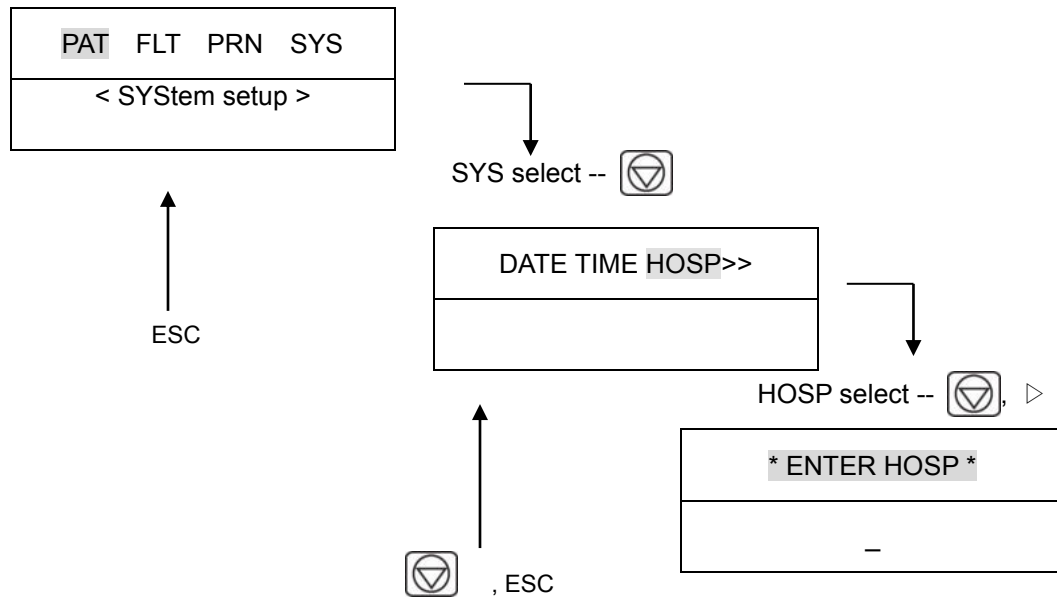

Hospital name can be entered in up to 16 characters. To enter the name, select the required character in the current cursor position. As for [1ABC] key, the key toggles in the order of A, B, C, 1, A, ...whenever pressing that key.

So, if you want to enter B character, press > key to input B after pressing the [1ABC] key 2 times in the current cursor position. Then moves the cursor to the next. To exit the hospital name setting, press (down arrow icon) key or ESC key that moves to the menu above.

To enter the user name who operates the system, move the menu to SYS → DOC → \* ENTER DOCTOR \* as shown above. Then enter the user name in the same way.

## Language

To set a language for CARDIOCARE-2000, press and hold the ◀ key and turn the power on. You will then be redirected to the "Language" menu. In the 'Language' menu, press a number key (1 through ESC) to select a desired language (1: English; 2: Chinese; 3: German; 4: French; 5: Russian; 6: Spanish; 7: Italian; 8: Turkish; 9: Polish; 0: Romanian and ESC: Portuguese).

After selecting a language, press the  key and the selected language will be applied to the system.

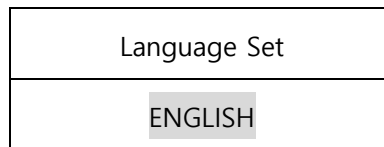

## **Chapter 2. Preparation for ECGs recording**

### **1) Electrode positions**

### **2) Electrode Connection**

Check before connection

Connecting the Electrodes

Connecting the patient cable

Lead-off troubleshooting

## 1) Electrode positions

To record the 12 standard leads ECGs [ I, II, III, aVR, aVL, aVF, V1, V2, V3, V4, V5, V6 ], connect the electrodes to the patient as follows ;

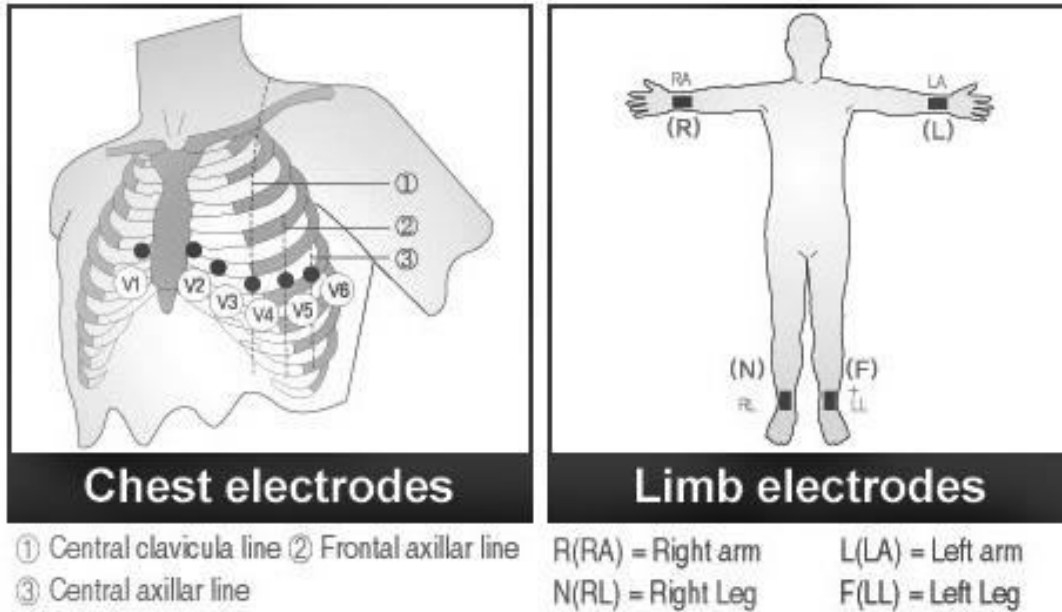

Electrode positions for limb leads are as follows;

N(RL) = Right leg

F(LL) = Left leg

R(RA) = Right arm

L(LA) = Left arm

## 2) Electrode connection

### Check before connection

Check the system connection before measuring the patient's ECG.

- Check that there's no mechanical hazard.
- Check the connection of external cable and accessories.
- Check all the measurement device to measure the patient's

### Connecting the Electrodes

Put the patient to bed in relaxed state and apply some ECG GEL. Connect the electrodes described in "Electrode Positions"

### Connecting the Patient Cable

Plug the patient cable into the input socket on the EKG2000. Defibrillation protected only if used with the original Bionet patient cable.

#### Warning

Use only electrodes and patient cables provided from Bionet Co.,Ltd. Otherwise Bionet Co.,Ltd takes no responsibility for accidents.

### Lead-Off troubleshooting

If lead connection status is O.K, READY indicator lamp lights up when power switch is turned on. If indicator lamp still does not light up after 10 seconds, it indicates lead-off status.

You can detect which one of leads is in lead-off status from operating MONITOR mode output. Lead-off status happens in 2 cases.

First, lead comes off from the patient body. In case of this, connect the lead to the patient body again.

Second, Conductivity between patient body and electrodes is poor. In case of this, apply some ECG gel to the electrodes and reapply it to the patient..

In exceptional circumstances if you are still troubled with poor EKG signal after troubleshooting as described above, it can be a problem with the patient cable. Contact Service Center of Bionet Co.,Ltd..

## **Chapter 3. Recording of ECGs**

### **1) Introduction**

### **2) Basic Setting**

- General Information
- Signal Level Setting
- Signal Display Setting
- Filter Setting
- Channel Form Setting
- Rhythm Lead Setting
- Grid Setting
- Monitoring Form Setting
- Monitoring Channel Setting
- Diagnosis on/off setting
- Enter patient data





### **3) Monitor Mode Output**

- Output Method
- Output Form





### **4) Record Mode Output**

### **5) Copy Mode Output**

## 1) Introduction

1. Turn the power switch on after connecting leads to the patient according to preparation for ECGs recording of Chap2.
2. Set the filter, signal level, display speed, channel form, rhythm lead according to “Basic Setting” of Chapter3..
3. Enter the patient information according to “Basic Setting –Enter Patient Data” of Chapter 3.
4. Press the REC  key to record patient ECGs after READY indicator lamp lights up
5. In case READY indicator lamp does not light up, press MONI  key to check out the ECG signal. If you are still troubled with poor signal, take necessary steps according to “Lead-off troubleshooting” of Chapter 2 .
6. Press COPY  key to print the same report as previously printed one. Press  key to exit during printing or recording of ECGs.

For a convenient operation, memorize the short keys described below.

	MONITOR : Displays real-time ECGs from the patient continuously or monitoring the patient ECGs for long time,
	RECORD : Records ECGs for 10 seconds by pressing key and prints in A4 sized report form after calculating the measurement parameter of the recorded ECGs
	COPY: Prints the same report as previously printed one in record mode or prints after changing system setting such as filter, signal level, output speed, channel form, rhythm channel of previously recorded ECGs data in record mode
	STOP: Exit during printing or recording of ECGs



## 2) Basic setting

### General information

LCD displays current system setting in the order of signal level, printing speed, base line filter ,EMG filter, heart rate, channel form, rhythm channel when system is turned on . These settings can be changed by two kinds of methods. First method is to use short keys. System setting can be easily changed by pressing short keys of control panel that accord with the icons displayed on the LCD screen. Second method is to use menu. Once, move to menu mode while LCD displays current system setting by presage  key and then select "PAT", "FLT", "PRN". "PAT" can be used to enter the patient information. , "FLT" can be used to select the filter. "PRN" can be used to adjust printing.

### Signal Level Setting

The signal level should be adjusted in case that signal overlaps with neighboring traces or the amplitude of pulse is too small to interpret.

Signal Level setting is adjustable in four ways. The entire 12 channel is set to each out of 5mm/mV, 10mm/mV, 20mm/mV and aut (Auto gain control) which sets I, II, III, aVR, aVL, aVF to 10mm/mV , V1, V2, V3, V4, V5, V6 to 5mm/mV .

As for 5mm/mV, it indicates that the amplitude of 1mV pulse is amplified into 5mm.

To change the signal level, press SENS  key to select the required one.

SENS  key toggles between 5, 10, 20, aut that are displayed on the LCD.

The selected setting is shown on the bottom line of the output report indicated by 'all channels: 5mm/mV, all channels: 10mm/mV, all channels: 20mm/mV' as for 5, 10, 20 and ' I-aVF': 10mm/mV, V1-V6: 5mm/mV ' as for aut.

### Display speed setting

Display speed setting is to adjust the width of the output signal. Adjustable value is



12.5mm/s, 25mm/s, 50mm/s. As for 25mm/s, it indicates that ECG signal for 1sec is recorded in the width of 25mm. So, 12.5mm/s is half the width of 25mm/s, 50mm/s is double the width of 25mm/s. For wide range of signal display, set large value.

To change the printing speed, press SPD  key to select the required one.

SPD  key toggles between 12.5, 25, 50 that are displayed on the LCD.

The selected setting is shown on the bottom line of the output report indicated by '12.5mm/s, 25mm/s, 50mm/s'. For your reference, set printing speed to 25mm/s when prints with A4 size.

## Filter Setting



AC power noise, base line drift caused by breathing , EMG signal can be recorded along with the output ECG signal. To set the AC noise filter, move to “FLT” menu to call up “AC” menu and press  key.  key toggles between off, 50hz, 60hz. Off indicates that filter does not suppress ac interference. As for 50Hz or 60Hz, filter suppresses 50Hz or 60Hz AC power noise. In case of battery power, ECG signal is clear only with Off setting because AC noise interference hardly exist. The selection is 50Hz for most of Europe and 60Hz for USA and other countries. The selected setting is shown on the bottom line of the output form indicated by Cut off AC.



Base line drift is caused by patient breath. Base line drift filter can be set by pressing  key.

BASE  key switches on or off. On or off indicates base lien filter is applied or not. The selected setting is shown on the bottom line of the output form indicated by '0.1hz-' as for filter on and '0hz-' as for filter off.

EMG signal is induced from muscle and internal organs of the patient.

For clear ECG signal output, it is necessary to eliminate EMG signal interference.

EMG filter can be set by pressing MUSC  key. MUSC  key switches on or off. On or off indicates EMG filter is applied or not. The selected setting is shown on the bottom line of the output form indicated by Cut off EMG.

Low pass filter can be selected to optimize ECG signal after applying above three filters and if ECG signal is still interfered. To set the low pass filter, move the menu to “FLT” to call up “LPF” menu and press  key.  key toggles between off, 40hz, 100hz, 150hz. As for 40Hz, it indicates filter suppresses higher frequency than 40Hz. The selected setting is shown on the bottom line of the output form indicated by '-250hz-' as for off, by '-40hz' as for 40hz, by '-100hz' as for 100hz, by '-150hz' as for 150hz.

To apply filter could result in ECG distortion. So, filter should be appropriately applied to reduce the fluctuation without affecting the ECG signal when output signal is badly interfered only.

For your reference, base line file and ac filter should be always active and EMG filter can be applied appropriately. It is recommended for LPF to set 150Hz during diagnosis.

## Channel form setting

Channel form setting is to adjust the numbers of channel of output form.

This system provides four kinds of channel form of 3ch+1rhy, 6ch+1rhy, 12ch rhy, 60s 1rhy.

As for 3ch+1rhy, 10 seconds of ECG data are recorded in four consecutive segments of 2.5 seconds such as I, II, III for first 2.5 seconds time segment, aVR, aVL, aVF for second 2.5 seconds time segment, V1, V2, V3 for third 2.5 seconds time segment, V4, V5, V6 for last 2.5 seconds segment. And 1 channel rhythm is recorded for 10 seconds in lower part of the output form.

As for 6ch+1rhy, 10 seconds of ECG data are recorded such as I, II, III, aVR, aVL, aVF for first 5 seconds time segment and V1, V2, V3, V4, V5, V6 for next 5 seconds time segment. And 1 channel rhythm is recorded for 10 seconds in lower part of the output form.

As for 12ch rhy, 12 channel rhythms are simultaneously and continuously recorded in the order of I, II, III, aVR, aVL, aVF, V1, V2, V3, V4, V5, V6.

As for 60s 1rhy, 1 channel rhythm is recorded with 6 lines, 10 seconds to every line, for 60 seconds.

To set the channel form, press FORM key. FORM key toggles between 3ch+1rhy, 6ch+1rhy, 12ch rhy, 60s 1rhy that are displayed on the LCD.

The selected setting is shown on the top line of the output form indicated by '3 Channels + 1Rhythm Report' as for 3ch+1rhy, '6Channels + 1Rhythm Report' as for 6ch+1rhy, '12Channels Rhythm Report' as for 12ch rhy, '1Rhythm Report (60sec)' as for 60s 1rhy.

## Rhythm channel setting

Rhythm channel setting is to adjust the lead of output form. To set rhythm lead, press LEAD key. LEAD key toggles between I, II, III, aVR, aVL, aVF, V1, V2, V3, V4, V5, V6 that are displayed on the LCD. The selected rhythm lead recorded in lower part of the output form for 10 seconds is the standard lead compared with other channel.

## Grid setting

Grid setting is needed if fax sheet is used as recording paper.

Grid is marked with solid line of 5mm X 5mm and with dot of 1mm X 1mm position.

In case of using standard ECG recording paper supplied from Bionet Co.,Ltd instead of using fax sheet, grid setting should be off because grid is already marked on recording paper.

To set the grid, moves the menu to \* **GRID** \* as following steps.

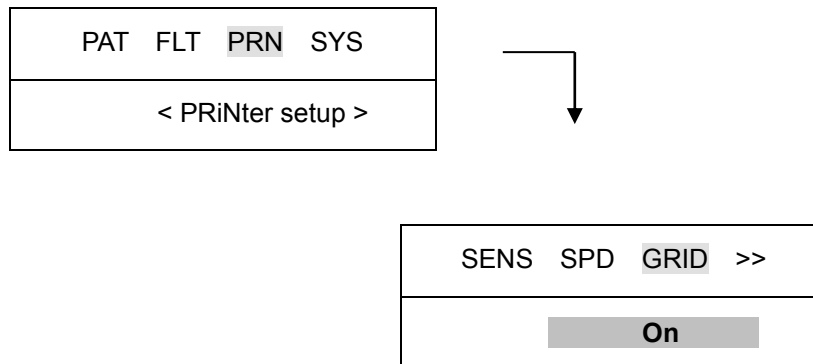



key switches on or off . If set to on, grid is recorded on the recording paper.  
If set to off, grid is not recorded on the recording paper.

## Monitoring form setting

You can set up the real time printing size.

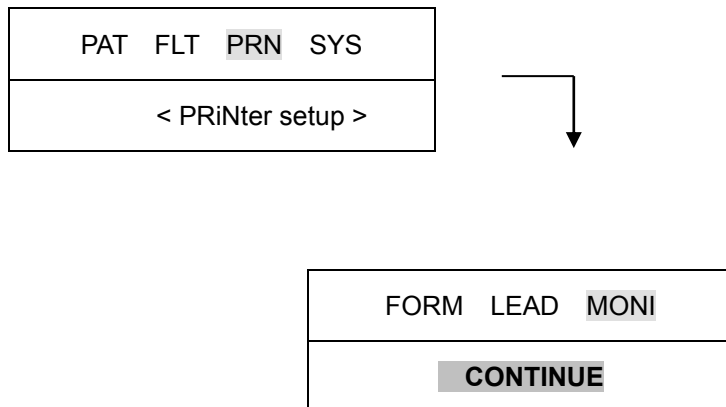
To set the monitoring form, moves the menu to \* **MONI** \* as following steps.





 key switches continue or A4 report. If set to continue, the lead will be printed out continuously until you press the  key on the control panel. If set to A4 report, print out the 10-second data in the form of A4 paper.

## Monitoring channel setting

Monitoring channel setting is to adjust the numbers of channel of monitoring form. This system provides four kinds of channel form of 3ch, 6ch, 12ch.

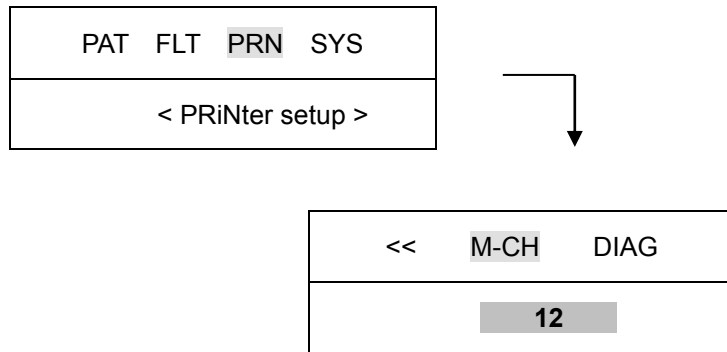
To set the monitoring channel, moves the menu to \* **M-CH** \* as following steps.



 key switches 3, 6 and 12 . If set to 3, print 3 channels at the same time (I ~ III / aVR ~ aVF / V1 ~ V3 / V4 ~ V6) If you want to change the channel, press the  on the control panel.

If set to 6, print 6 channels at the same time (I ~ aVF / V1 ~ V6) If you want to change the channel, press the  on the control panel.

If set to 12, print 12 channels at the same time (I ~ V6).

## Diagnosis on/off setting

When you print out the diagnosis report, you can choose the result of diagnosis is printed out or not on the report.

To set the diagnosis, moves the menu to \* **DIAG** \* as following steps.

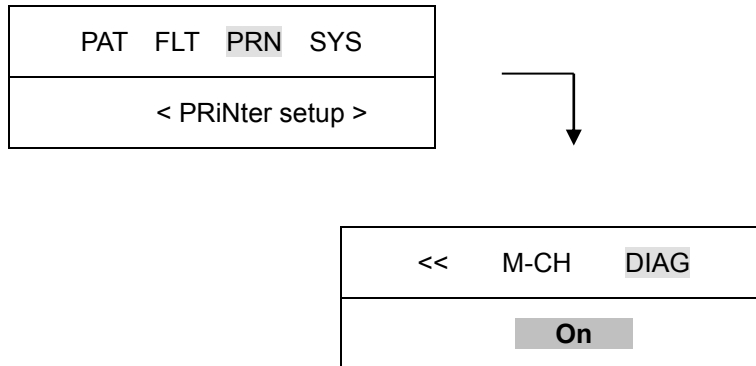

key switches on or off . If you set up ON, the result of diagnosis is printed out, and if you set up OFF, the result of diagnosis is not printed out on the report.

## Enter Patient Data

Patient information including patient ID, name, age, sex, height, weight can be entered. There are two methods to enter patient data. First, move the menu to patient data menu by pressing PAT  key. Second, move the menu to "ID" as following steps.

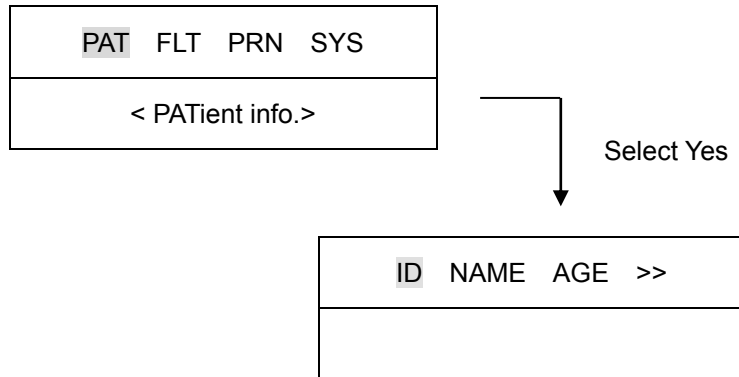

When there are previous patient data, following window appears on the LCD whether to change data of the previously recorded one or to select new patient.

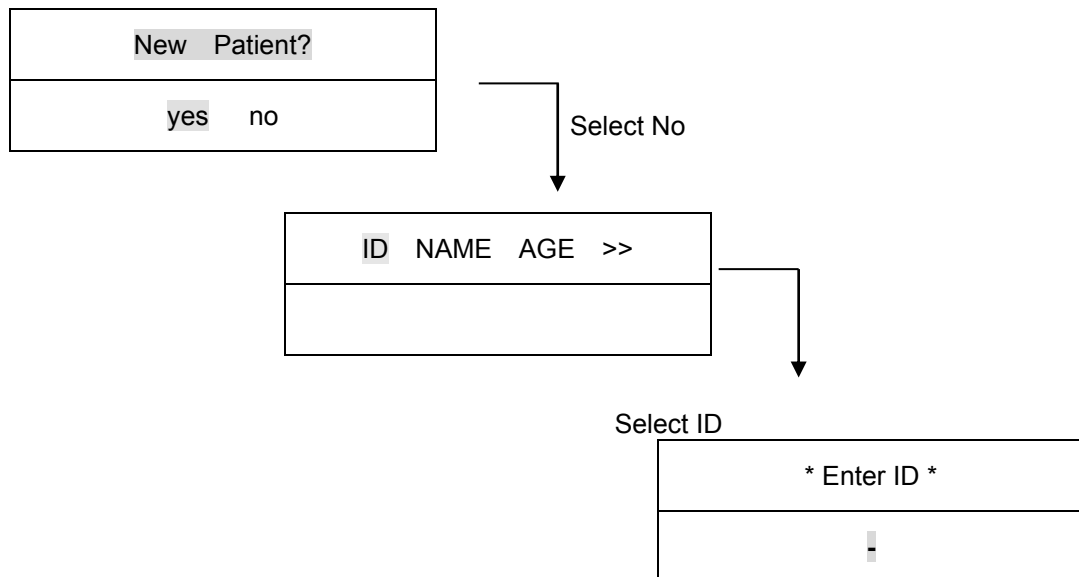



# CardioCare2000 Operation Manual

All the other patient data are deleted with selecting yes and then move the menu to “ENTER ID” for new patient data entry.  
Previous patient data are displayed on the LCD as follows with selecting no;

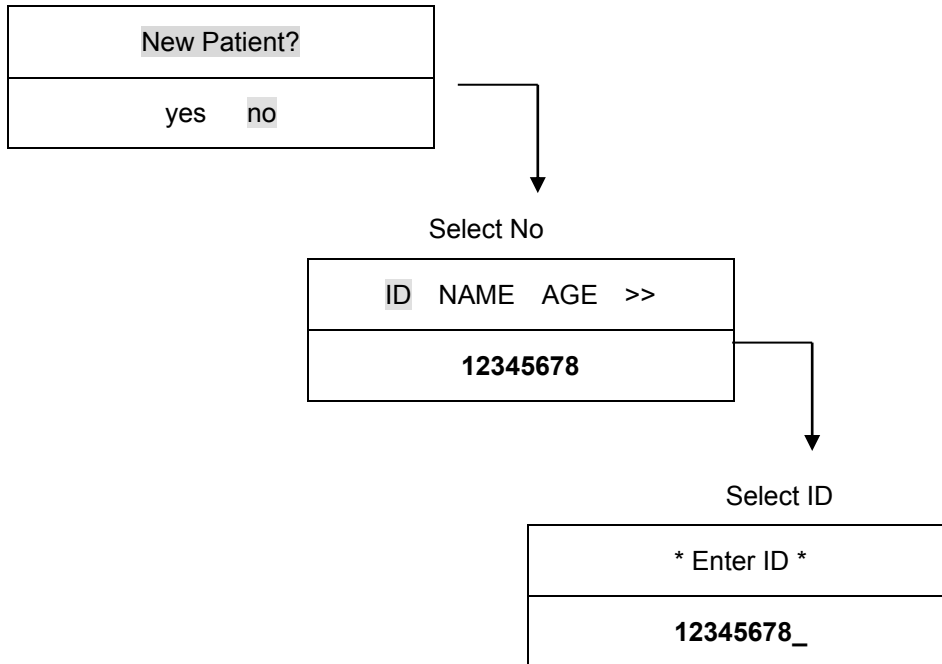

To enter patient ID, move the menu to “ENTER ID” as following steps;

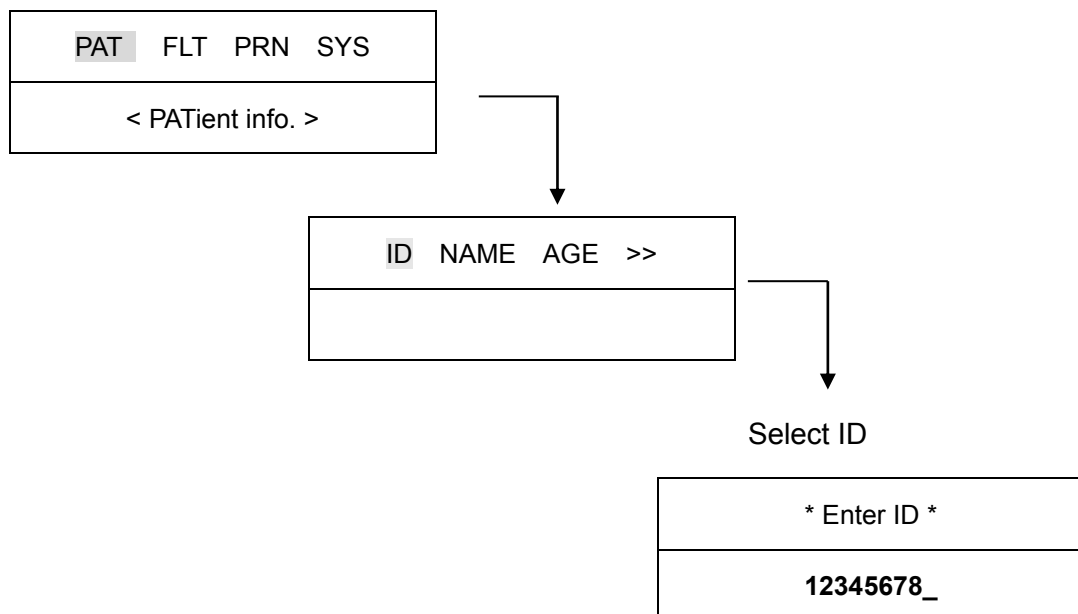

# CardioCare2000 Operation Manual

Patient ID can be entered in up to 15 characters. ID number is entered by pressing 0,..., 9 numeric key in the current cursor position. Wrongly typed number can be deleted with  $\triangleleft$  key. Use  $\triangleright$  key to enter '-'. ID entry can be combined with numbers of 123-456-789 and '-'. To exit the ID entry press  key or ESC key that moves to the menu above.

To enter patient name, move the menu to **"ENTER NAME "** as following steps;

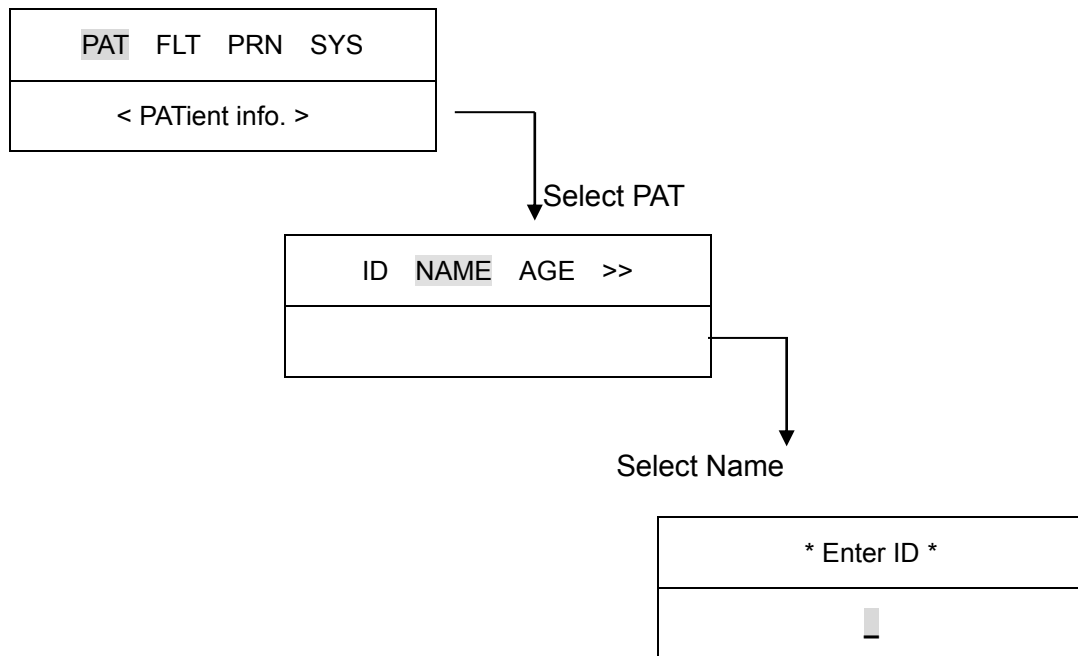

Patient name can be entered in up to 16 characters. To enter the name, select the required character in the current cursor position. As for [1ABC] key, the key toggles in the order of A, B, C, 1, A, ...whenever pressing that key.

So, if you want to enter B character, press  $\triangleright$  key to input B after pressing the [1ABC] key two times in the current cursor position. Then moves the cursor to the next. To exit the patient name press

 key or ESC key that moves to the menu above.

# CardioCare2000 Operation Manual

To enter age, move the menu to “ENTER AGE” as following step ;

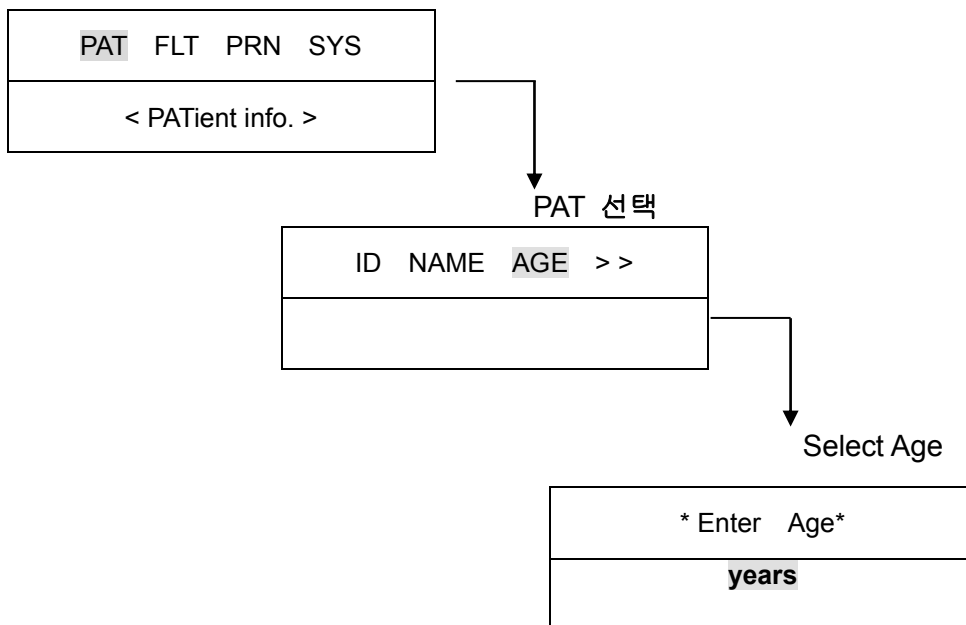

Age can be entered in up to 3 figures. Age is entered by the unit of year. Age is entered with pressing 0,..., 9 numeric key in the current cursor position and cursor automatically moves to the right. To exit Age enter press  key or ESC key that moves to the menu above.

# CardioCare2000 Operation Manual

To enter sex, move the menu to “ENTER SEX” as following steps ;

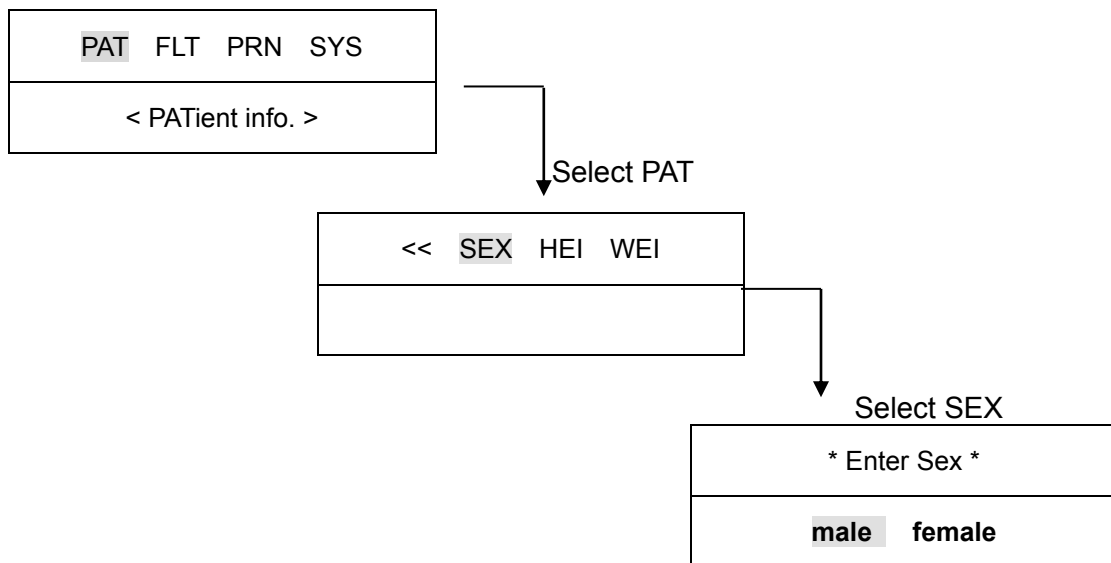

Sex can be selected between male and female with  $\triangleleft \triangleright$  key. To exit sex press  key or ESC key that moves to the menu above.

To enter height, move the menu to “ENTER HEIGHT” as following step;

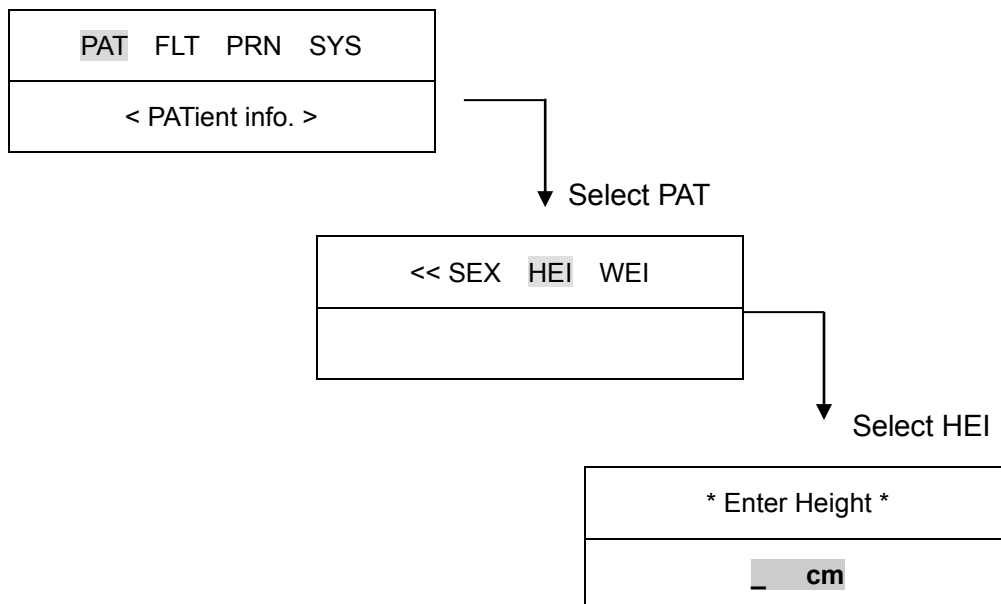

Height can be entered in up to 3 figures. Height is entered by the unit of cm. Height is entered with pressing 0,..., 9 numeric key in the current cursor position and cursor automatically moves to the right. To exit height press  key or ESC key that moves to the menu above.

# CardioCare2000 Operation Manual

To enter weight, move the menu to “ENTER WEIGHT” as following steps ;

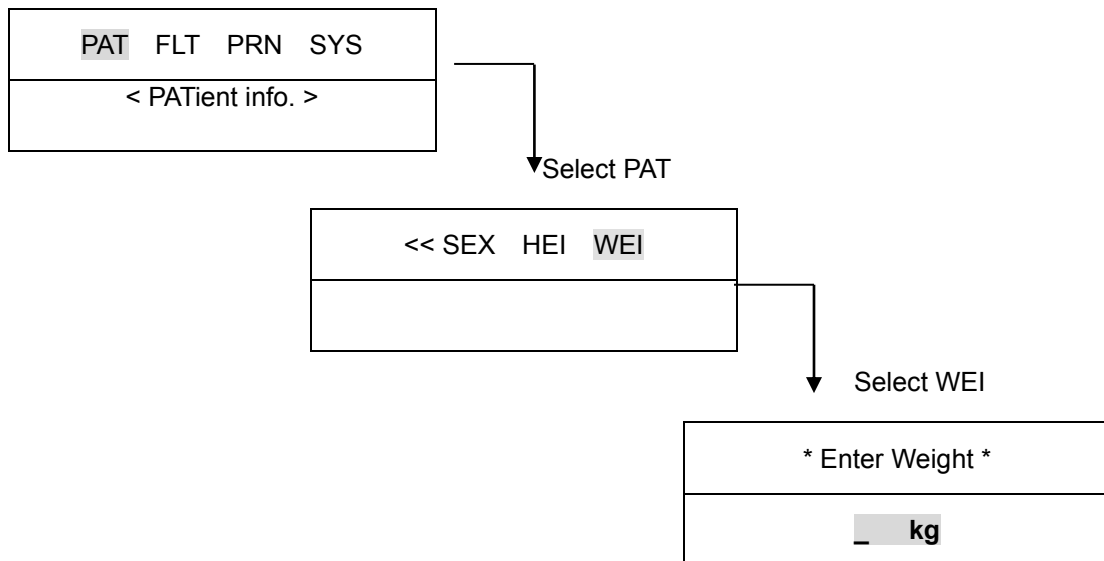

Weight can be entered in up to 3 figures. Weight is entered by the unit of kg. Weight is entered with pressing 0,..., 9 numeric key in the current cursor position and cursor automatically moves to the right.

To exit Weight press  key or ESC key that moves to the menu above.

## 3) Monitor mode output

In monitor mode output, the measured ECGs is displayed in real-time. This output function can be used for the purpose of checking out that the entire channel signal is active before recording ECGs and monitoring ECGs of the patient for long time.

In this monitor mode, filter setting is fixed as follows ;



BASE LINE	On
Muscle filter	Off
AC Rejection Filter	60hz
Low Pass Filter	40hz

Printing speed can be set to 12.5 mm/s, 25mm/s, 50mm/s and signal level can be set to 5mm/mV, 10mm/mV, 20mm/mV, aut.

### Output method

Filter setting value is fixed. Set the required printing speed and signal level and press MON  key. Then, the system starts printing according to the selected speed with the following message on the LCD.

* MONITOR *
<b>Printing</b>

Press  key or  key to stop printing. Then system stops printing and displays system setting after indicating following message for 1 second on the LCD.

* MONITOR *
<b>aborted!</b>

### Output form

In monitor mode output, 12 channel rhythms are printed simultaneously and continuously as shown below.

Indicated heart rate is the average of previous 8 heart rates.

If the MONI M-CH is set at 3 or 6, please press  key to start printing.

When you press  key again the lead is changed to next group and the printing starts.

If you want to stop in the middle of printing, press the  key.

## 4) Record mode output

In record mode output, ECGs is recorded on the memory first and displayed according to the selected signal level, output display speed, channel form after applying the selected filter and calculating the measurement parameter including heart rate, PR interval, QRS duration, QT/QTc, P-R-T axes of the recorded ECGs.

### 10 seconds ECG recording

Press  key when channel form is set to 3ch+1rhy, 6ch+1rhy, 12ch rhy

Then, the system starts recording data for 10 seconds on the memory with the following message indicates recording time on the LCD.

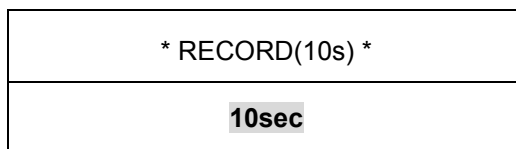

After recording data for 10 seconds, the system starts applying the selected filter and calculating the measurement parameter of the recorded ECGs with the following message on the LCD.

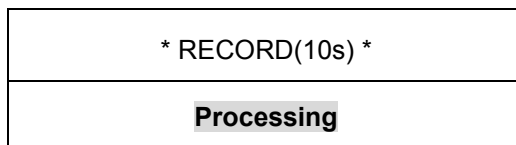

After data processing , the system starts printing with the following message on the LCD.

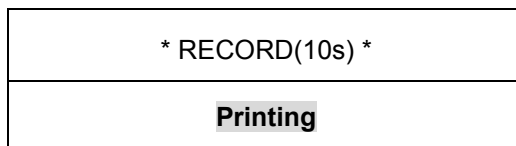

Press  key to exit during recording or printing data. Then, system stops recording or printing and displays system setting after following message for 1 second on the LCD.



## 60 seconds ECG recording

Press  key when channel form is set to 60s 1rhy.

Then, the system starts recording data on the selected rhythm channel for 60 seconds on the memory with the following message indicates recording time on the LCD.

* RECORD(10s) *
<b>60 sec</b>

After recording data for 60 seconds, the system starts applying the selected filter and calculates the heart rate of the recorded ECGs with the following message on the LCD.

* RECORD(60s) *
<b>Processing</b>

After data processing , the system starts printing with the following message on the LCD.

* RECORD(60s) *
<b>Printing</b>

Press  key to exit during recording or printing data. Then, system stops recording or printing and displays system setting after indicating following message for 1 second on the LCD.

* RECORD(60s) *
<b>Aborted!</b>



## Output form

The printing forms are described and the example of printing form by each channel form is provided below.

### RHYTHM REPORT FORM

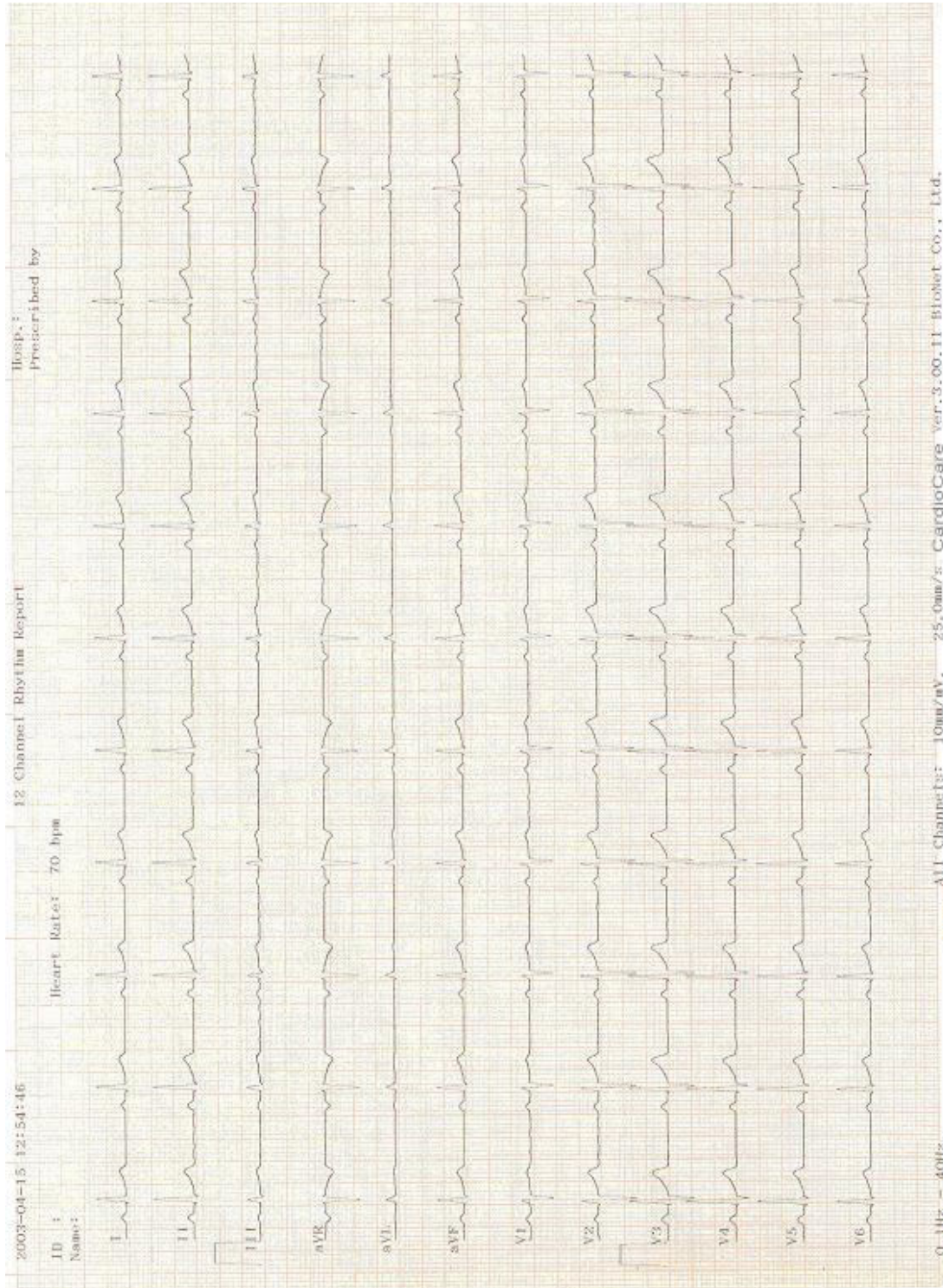

## RECORD REPORT FORM( 3ch+1rhy )

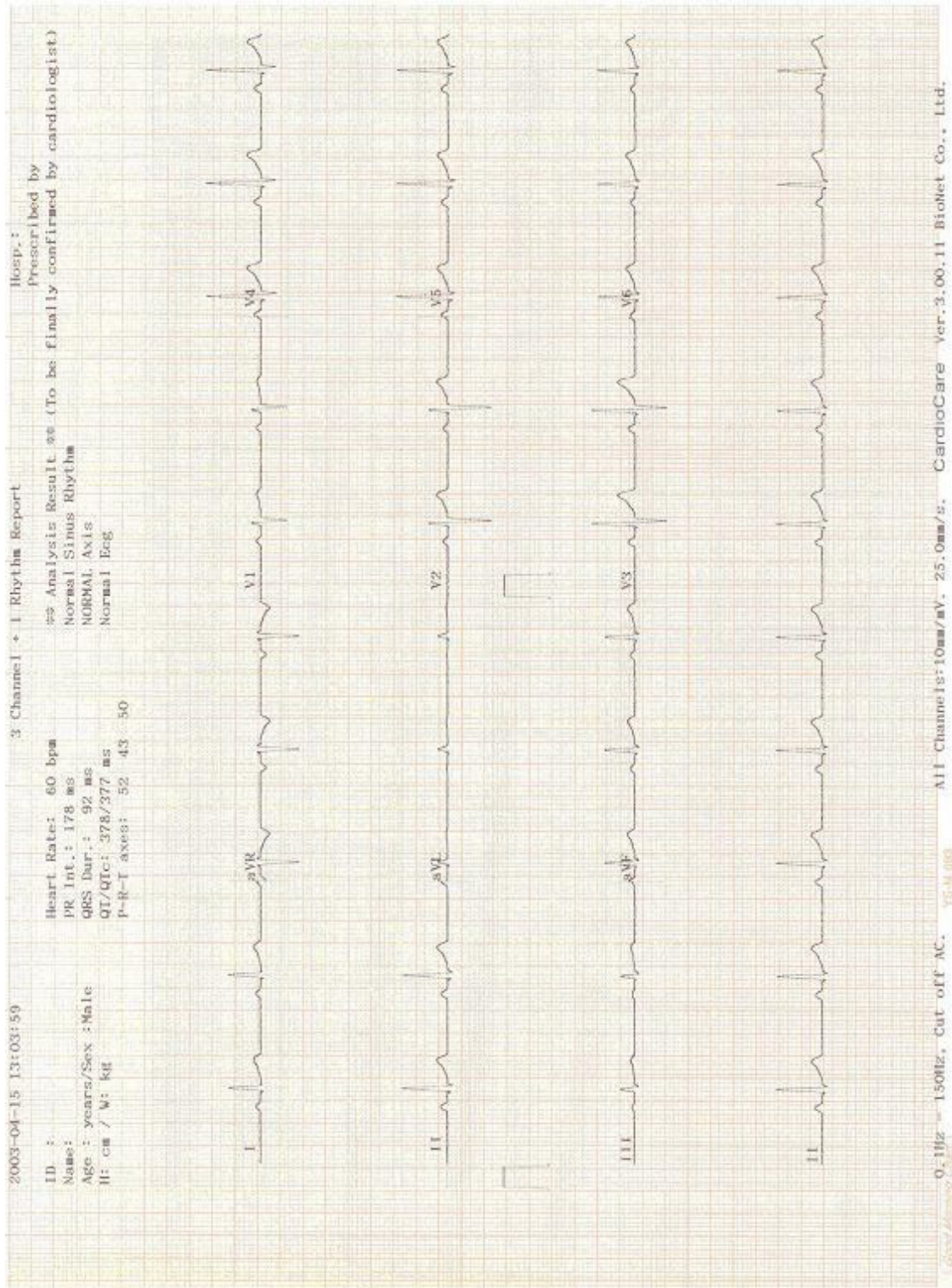

0.1Hz - 150Hz, Cut off AC. Y6-4 000 All Channel Is: 10mm/mV, 25.0mm/s. CardioCare Ver.3.00.11 BioNet Co., Ltd.



## RECORD REPORT FORM( 6ch+1rhy )

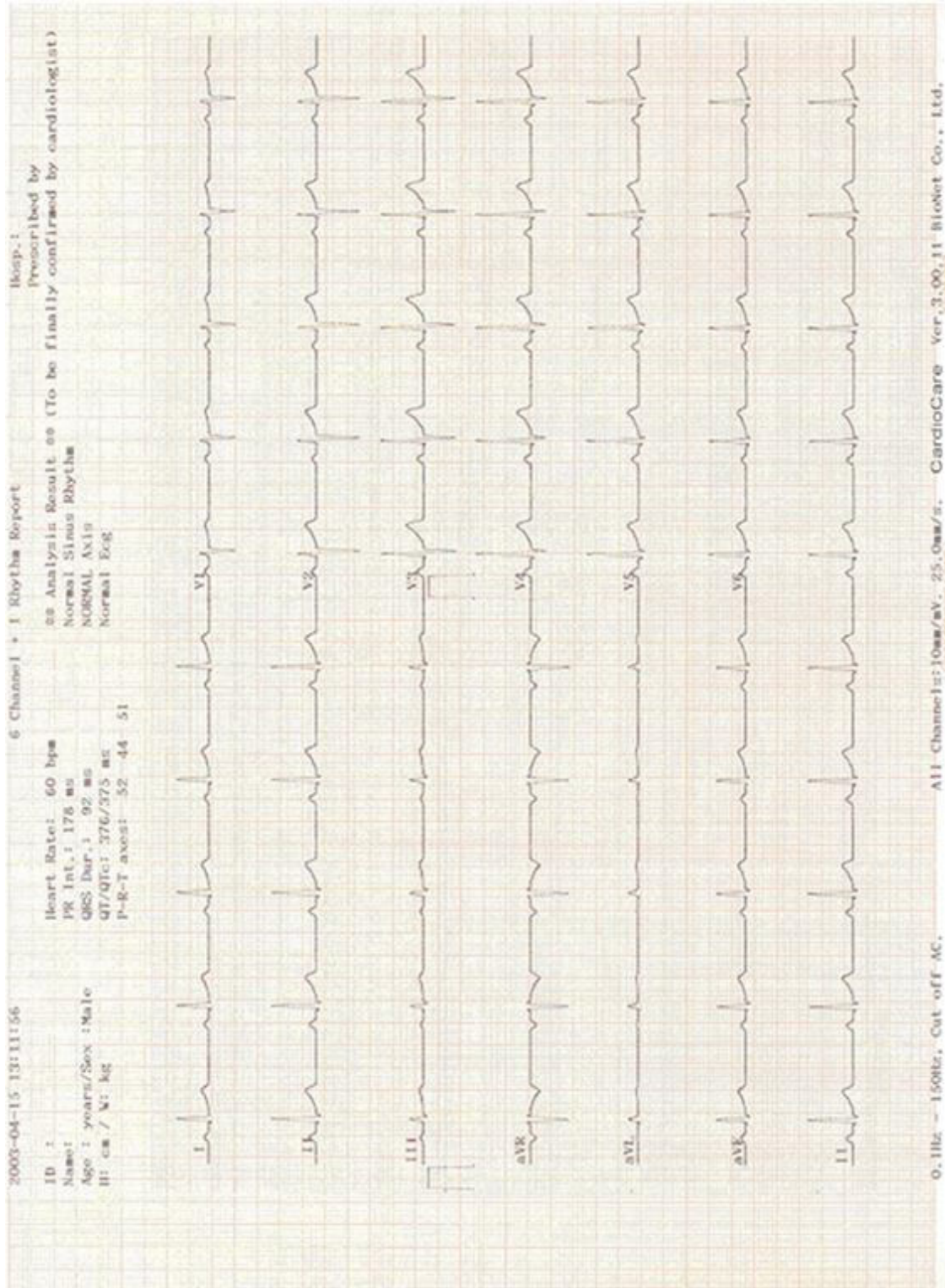

## RECORD REPORT FORM( 12ch rhy )

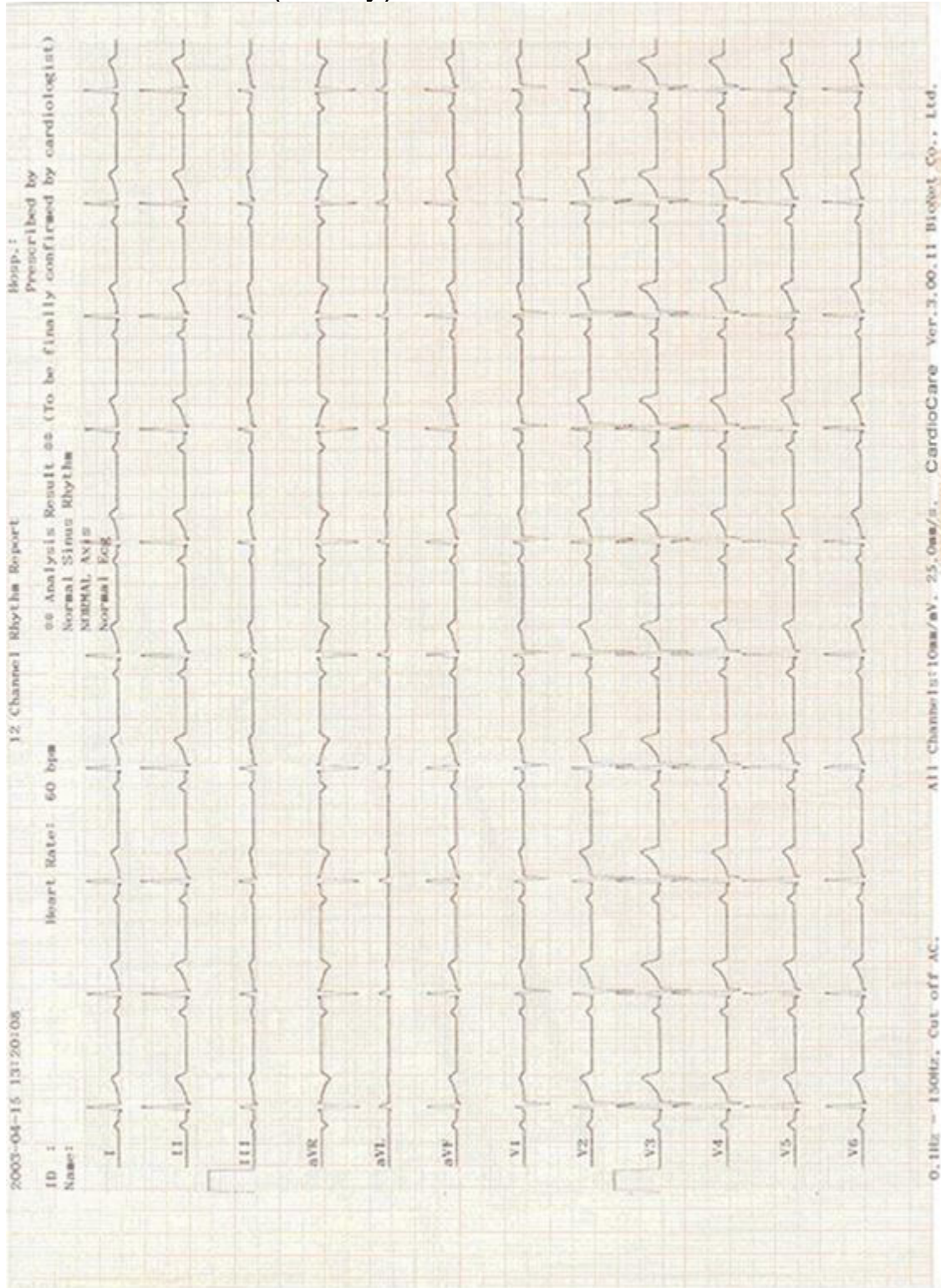



## RECORD REPORT FORM( 60s 1rhy )



### Output form

These are the explanation of the output form and examples according to each channel form.

## 5) Copy mode output

Copy mode output function is to print the same report as previously printed one or print after changing setting such as filter, signal level, output display speed, channel form, rhythm channel of previously recorded ECG data .

System starts printing the same report as previously printed one with the following message on the LCD by pressing  key after record mode printing.

* COPY *
<b>Printing</b>

If copy mode printing is tried without operating record mode printing, system displays system setting after indicating following message for 1 second on the LCD.

* COPY *
<b>!!No Record Data</b>

If filter setting is changed to the previously recorded ECG data, the system starts applying changed filter with the following message on the LCD.

* COPY *
<b>processing</b>

After filter processing, the system starts printing with the following message on the LCD.

* COPY *
<b>printing</b>

After printing is finished, the system displays system setting after indicating following message for 1 second on the LCD.

* COPY *
<b>Finished!</b>

Press  key to exit during printing data. Then, system stops printing and displays system setting after indicating following message for 1 second on the LCD.

* COPY *
<b>Aborted!</b>

## Warning

When a defibrillator is used, do not touch the patient, table, or apparatus.

## Warning

When you are connecting to the electrodes or the patient cable, make sure that the connectors never come into contact with other conductive parts, or with earth. In particular, make sure that all of the ECG electrodes are attached to the patient, to prevent them from contacting conductive parts or earth.

## Warning

Use the provided ECG patient cable for measuring ECG in the operating room. Patient cable cannot be used for measuring respiration.

## Caution

Do not use EKG3000 in combination with any Electro-Surgical (ES) equipment.

## Caution

Users must use same type of electrode or any other biocompatibility certified ones that have been proved by International Standard.

## Caution

This device must be operated under health care professional when applying to pacemaker treated patient.

## **Chapter 4. System control**

- 1) Maintenance and Cleaning**
- 2) Regular Inspection**
- 3) Troubleshooting**



## 1) Maintenance and Cleaning

EKG 2000 can be kept clean and maintained in a various method. Avoid damage or disinfection of the unit as recommended follow.

The warranty does not cover the damage resulting from using materials (unauthorized material) which may cause damage of the product even during the warranty period.

### Caution!

Check the main unit and electrodes thoroughly after cleaning. Do not use the old and damaged equipment. Please consult with your hospital biomedical Engineer to determine the device condition.

Main unit and electrodes should be wiped with soft cloth dampened with warm water to keep clean. Wipe with absorbent cotton soaked with alcohol once a month. Do not use lacquer, ethylene, acidic liquids.

Cable should be kept clean not to stain dust or filth and wiped with soft cloth dampened with warm water(40 ° C / 104 F). Wipe with absorbent cotton soaked with clinical alcohol once a month Do not, under any circumstance, immerse the equipment and ECG cable into cleaning liquids or detergents. Do not insert any kind of liquids into the equipment and ECG cable.

## Disposal of your old appliance

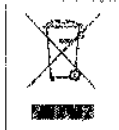

1. When this crossed out wheeled bin symbol is attached to a product it means the product is covered by the European Directive 2002/96/EC.
2. All electrical and electronic products should be disposed of separately from the municipal waste stream via designated collection facilities appointed by the government or the local authorities.
3. The correct disposal of your old appliance will help prevent potential negative consequences for the environment and human health.
4. For more detailed information about disposal of your old appliance, please contact your city office, waste disposal service or the shop where you purchased the product.

### WARNING

This product contains a chemical known to the State of California to cause cancer, birth defects, or other reproductive harm.

## 2) Regular Inspection

In common with all medical equipment, it is recommended that a safety check of EKG2000 should be carried out once a year. Refer to Service manual offered by Bionet Co., Ltd. on the extent of the check.

## 3) Troubleshooting

1. In case that buzzer alarms for 1 second during printing and following message appears on the LCD ;

* RECORD *
<b>Paper empty!</b>

This indicates that printer run out of printing paper. Operate again after replacing printing paper.

2. In case that nothing can be printed out or printout fades ; Top cover of the printer is not closed completely. Operate again after closing firmly
3. In case that buzzer alarms three times in series when system is on battery power, following message appears on the LCD.:

* Low Battery *
<b>Power off</b>

This indicates that the battery is almost discharged. Turn the system power off and connect the ac power source. Then turn the system power on again.

4. In case that ECGs is interfered with power noise;  
First, move the menu to FLT → AC and check if AC is set to 60Hz..

If ECGs is still interfered even if ac filter is set to 60Hz, connect the potential equalization connector with the common ground conductor. Do not connect the potential equalization conductor with the ac power system ground. The metallic frame of the patient's bed or another metallic object connected with building can be used for grounding.

## Chapter 5. Specification

### TECHNICAL DATA

- Input circuit : Isolated and defibrillation protected
- ECG leads : Standard 12 leads
- Sensitivity selection : 5,10,20 mm/mV  $\pm$  5 %
- Calibration voltage : 1mV  $\pm$  2 %
- Electrode offset tolerance :  $\geq \pm$  250mV
- Resolution : 2  $\mu$ V, 500 Sample/Sec
- Frequency response: 0.05 ~ 150Hz
- Common mode rejection : > 100 dB
- Input impedance : 10 M $\Omega$
- Patient leakage : < 50  $\mu$ A
- Signal quality control : Disconnected lead detection
- Communication : PC connection with RS-232 interface and LAN
- Display : 2x16 char LCD Display
- Registration Resolution :
  - Vertical : 8 points/mm; Horizontal: 25  $\mu$ m at 25 mm/S
  - Paper type : Thermal, roll paper
  - Paper width : A4: 210 mm or 8.5" ; Length : A4 : 300 mm or 11"
- Keyboard : Membrane keyboard
- Electrical :
  - Power supply : AC or built-in Battery(option)
  - Voltage rating : 100 - 240Vac (50/60 Hz)
- Environment :
  - Operating Temperature : 15°C to 30°C (59°F to 86°F)
  - Storage Temperature : - 20°C to 60°C (- 4°F to 140°F)
  - Storage Humidity : 10% to 95% RH, non-condensing
  - Operating Altitude : 70(700) to 106Kpa(1060mbar)
- RS232C Interface
  - Protocol: asynchronous
  - Baud rate: 19200
  - Byte format: 8 data bit, 1 stop bit, no parity bit
  - Connection socket: 9 pole female, wired as DTE(Data Terminal Equipment)
  - Pin connection: 3=TXD(out), 2=RXD(in), 6=DSR, 4=DTR, 5=GND

## Warranty

Product Name	<b>Electrocardiograph</b>
Model Name	<b>CardioCare-2000</b>
Approval No.	
Approval Date	
Serial No.	
Warranty period	One year from date of purchase (Two years in Europe)
Date of purchase	
Customer	Hospital : Address : Name : Tel :
Sales Agency	
Manufacturer	

- ※ Thank you for purchasing CardioCare-2000.
- ※ This product is manufactured and passed through strict quality control and thorough inspection.
- ※ Compensation standard concerning repair, replacement, refund of the product complies with “Consumer’s protection law” noticed by Economic Planning Dept.

## **International Sales & service**

**Bionet Co., Ltd. :**

5F, Shinsegae I&C Digital Center 61 Digital-ro 31 gil,  
Guro-gu, SEOUL 08375, REPUBLIC OF KOREA

Tel : +82-2-6300-6410 / Fax : +82-2-6499-7789 / e-mail: sales@ebionet.com

Website: [www.ebionet.com](http://www.ebionet.com)

## **U.S.A sales & service representative**

**Bionet America, Inc. :**

2691, Dow Ave, Suite B  
Tustin, CA 92780 U.S.A.

Toll Free: 1-877-924-6638 / Fax: 1-714-734-1761 / e-mail: support@bionetus.com

Website: [www.bionetUS.com](http://www.bionetUS.com)

## **European sales & service representative**

**MGB Endoskopische Geräte GmbH Berlin :**

Schwarzschildstraße 6

D-12489 Berlin, Germany

Tel: +49(0)-30-6392-7000 / Fax: +49(0)-30-6392-7011 / e-mail: sales@mgb-berlin.de

Website: [www.mgb-berlin.de](http://www.mgb-berlin.de)

**Bionet Co.,Ltd.**

**Product Name: CardioCare2000**