

LIFEPAK® 20e

defibrillator/monitor

Instructor guide



Contents

How to use this guide	1
Training tips	1
AED training course	3
Learning objectives	3
Equipment and materials.....	3
LIFEPAK 20e defibrillator/monitor AED training class	3
Early defibrillation	4
Biphasic energy	4
Controls and features	5
Device maintenance	6
AED operation	8
Manual training course	11
Learning objectives	11
Equipment and materials.....	11
LIFEPAK 20e defibrillator/monitor Manual User Training Class	12
Early defibrillation	12
Biphasic energy	13
Controls and features	13
Additional areas not shown	21
Device maintenance	22
Manual defibrillation	24
Synchronized cardioversion procedure	26
Noninvasive pacing	28
ECG monitoring	31
Optional feature: Pulse oximetry	33
Optional feature: EtCO₂	34
Data management	35
Other functions	37

How to use this guide

The LIFEPAK 20e defibrillator/monitor is easy to use and enables clinicians at every level to focus on the most important task at hand—saving a patient’s life. The LIFEPAK 20e defibrillator/monitor is highly intuitive to use, and adapts to various patient environments. With this comprehensive guide, you’ll be able to train your staff to effectively use the device.

This instructor guide is an introduction to the basic operation of the LIFEPAK 20e defibrillator/monitor. It does not suggest protocols or policies regarding the use of the defibrillator. **Refer to Operating Instructions for complete directions for use, indications, contraindications, warnings, precautions, and potential adverse events.**

This guide is designed for use with the factory default configuration of the LIFEPAK 20e defibrillator/monitor, which is compliant with the 2015 American Heart Association Guidelines. It is important to be familiar with the configuration of your particular defibrillator. Moving, removing, highlighting, and adding content to this outline to meet individual user needs is encouraged. Hands-on practice and application with scenarios promote learning retention.

Training tips

This guide is divided into four sections:

AED operation

Manual operation

Optional features

Data management and other functions

The AED mode is easy for healthcare professionals of all skill levels to quickly understand and use. This training course reviews the basic operation of the LIFEPAK 20e defibrillator/monitor in AED mode. The manual mode operation is for the ALS providers and reviews the manual operation and functions of the LIFEPAK 20e defibrillator/monitor.

The LIFEPAK 20e defibrillator/monitor retains data for two or more patients when you switch the power off or remove the batteries. The device automatically stores a CODE SUMMARY™ report as part of the patient report for each patient. This section describes how to access this information and other functions associated with the LIFEPAK 20e defibrillator/monitor.

All sections are optimally taught in a hands-on format. Instructors should first demonstrate how to use the defibrillator and then have students practice. Ideally, students will receive enough practice and coaching from the instructor to ensure they can use the device with confidence in an actual emergency.

AED operation

AED training course

The AED mode is highly intuitive and easy for healthcare professionals of all skill levels to quickly understand and use. This training course reviews the basic operation of the LIFEPAK 20e defibrillator/monitor in AED mode.

Learning objectives

The overall objective of this inservice is to provide an overview of the basic steps of operation of the identified controls, indicators, and connectors of the LIFEPAK 20e defibrillator/monitor. Upon completion of this course, participants will be able to:

- Verbalize the importance of early defibrillation.
- Locate and identify the defibrillator's front panel controls, indicators and connectors.
- Demonstrate QUIK-COMBO® electrode application.
- Demonstrate steps for automated external defibrillation (AED).
- Demonstrate the paper change.
- Demonstrate routine daily testing.

Equipment and materials

The following is a list of accessories and support material recommended for training on the LIFEPAK 20e defibrillator/monitor. It is essential that all equipment be inspected and tested to ensure proper function prior to training according to the Basic Orientation section of the Operating Instructions.

Equipment

- LIFEPAK 20e defibrillator/monitor

Accessories

- QUIK-COMBO therapy cable
- Test plug
- EDGE System™ electrodes with QUIK-COMBO connector (or clip-on training electrodes)
- 3-lead or 12-lead patient simulator
- AC power cord
- 50 mm ECG printer paper

Support materials

- Quick Reference Cards
- Student Study Guide
- Operating Instructions
- Performance Evaluations

LIFEPAK 20e defibrillator/monitor AED training class

The following lists the content that should be covered during a typical AED Operation Training Class.

- Early Defibrillation
- Biphasic Technology
- Controls and Features
- AED Operation
- Device Maintenance

Early defibrillation

A New England Journal of Medicine study of 6,789 in-hospital cardiac arrest events due to ventricular fibrillation or pulseless ventricular tachycardia reported 70% received defibrillation in 2 or less minutes from recognition of Cardiac Arrest (CA). The survival rate (significantly) declined for the 30% of the patients who received defibrillation more than two minutes after cardiac arrest.¹

The American Heart Association (AHA) Guidelines for cardiopulmonary resuscitation recommended defibrillation within 2 minutes of collapse in the hospital setting. The AHA suggests hospitals deploy AEDs throughout the hospital to achieve the target time and train staff to use the AEDs.

AEDs can help your hospital staff improve their ability to deliver the first shock within the recommended 2 minute guidelines. The LIFEPAK 20e defibrillator/monitor can be used in AED mode to defibrillate without having to learn ECG interpretation. The AED is simple to use because it is designed to automatically analyze the patient's heart rhythm and advise you which steps to take. In AED mode the device automatically selects the appropriate energy dosing.

Biphasic energy

Health care providers may be confused about the right energy dose for biphasic waveforms because different defibrillator manufacturers recommend different energy dosing protocols. It is important to clarify the correct recommended energy dose for biphasic waveforms in order to avoid possible confusion that may result in a delay of therapy. ADAPTIV biphasic technology provides the option to escalate to 360J for best results. Studies show that refrillation is common among ventricular fibrillation (VF) CA patients and that defibrillation of recurring episodes of VF is increasingly difficult.^{2,3,4} LIFEPAK devices give you the option to escalate your energy dosing up to 360J for difficult to defibrillate patients.

Fortunately, all AEDs are programmed to follow a predefined energy dosing protocol. In other words, the healthcare provider doesn't have to worry about energy dosing. The AED performs this automatically.

A biphasic waveform sends current one way at the start of the shock and then reverses it so the current flows in the opposite direction. A biphasic shock is a gentler but more effective shock. Stryker recommends a dosing protocol of 200-300-360 joules and is the factory default setting in all LIFEPAK defibrillators. Stryker believes this energy protocol can help minimize unnecessary CPR interruptions that result from ineffective defibrillation shocks.

Controls and features

In this section, the goal is to point out the different buttons and physical features pertinent to an AED user. Each of these features will be reviewed in greater detail later in this guide. Refer to the Operating Instructions for additional information.

AED buttons

Three buttons used for AED operation.

1. ON
2. ANALYZE
3. ⚡ (SHOCK)

Speed dial

Scrolls through and selects menu items.

Therapy cable connector

Connects therapy cable to the device

Manual button

Used to enter Manual Mode; pressing it opens the door and automatically takes the LIFEPAK 20e defibrillator/monitor out of AED mode and puts it into Manual Mode.

***Note: If the defibrillator is in AED mode and the door is open, or off, press ENERGY SELECT once to enter Manual Mode.** Full manual mode description is included in the Manual Mode Training Course for ALS providers.

Therapy cable (not shown)

The therapy cable is a defibrillation cable that attaches to therapy electrodes and to the test plug. The LIFEPAK 20e defibrillator/monitor should be stored with the therapy cable plugged into the lower right hand side of the device.

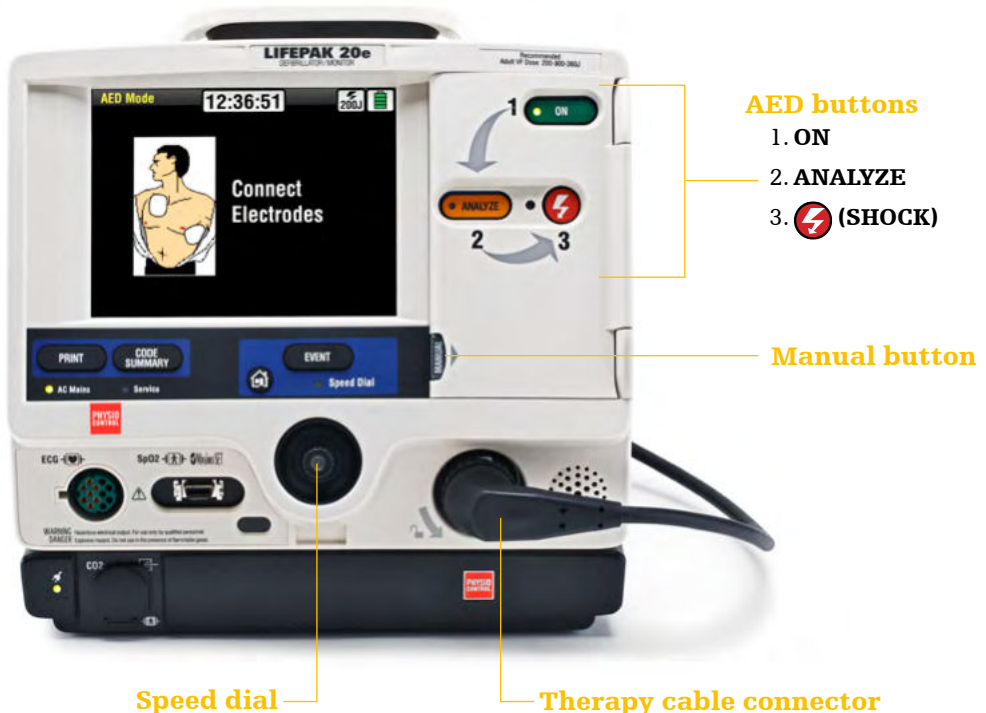

Device maintenance

Most hospitals have specific protocols for maintaining their defibrillators. Stryker provides a variety of tools designed to help manage inspection and maintenance procedures. Training for staff would depend on a hospital's particular approach.

BLS-trained responders should be familiar with several of the device maintenance procedures. How much detail you choose to go into will depend on your hospital's protocols.

References to buttons are indicated in **BOLD** and display messages are indicated in *ITALICS*. For complete information, review the Operating Instructions for the device.

The case list contains the following columns:

<p>Task Check defibrillator for Daily Auto Test results, if configured on.</p>	<p>User action, defibrillator labels, text/voice prompts & information</p> <ul style="list-style-type: none"> • Ensure the defibrillator is plugged in. • Ensure the therapy cable is plugged into the QUIK-COMBO test plug. <p>Or</p> <ul style="list-style-type: none"> • Ensure the standard paddles are clean, dry and properly seated in the paddle wells and connected to the defibrillator. <p>If the defibrillator detects a problem during the self-test it will remain "on" if connected to AC power and the <i>SERVICE LED</i> will illuminate and the printed report will indicate <i>SELF TEST FAILED</i>.</p> <p>If the defibrillator detects a problem while on battery power, the <i>SERVICE LED</i> will illuminate the next time it is turned on.</p> <p>Defibrillator should be checked daily following the auto test to confirm the test passed. If test failed or incomplete perform the manual user test.</p>
<p>Task Inspect the physical condition of the defibrillator.</p>	<p>User action, defibrillator labels, text/voice prompts & information</p> <p>Inspect Defibrillator for damage and foreign substances.</p>
<p>Task Inspect power source.</p>	<p>User action, defibrillator labels, text/voice prompts & information</p> <p>Confirm that the AC Mains LED light is on the LIFEPAK 20e defibrillator/monitor and CodeManagement Module (if applicable).</p>
<p>Task Check therapy and ECG electrodes.</p>	<p>User action, defibrillator labels, text/voice prompts & information</p> <p>Check QUIK-COMBO and EGG electrodes for "use by" date and that a spare set is available.</p>
<p>Task Examine accessory cables.</p>	<p>User action, defibrillator labels, text/voice prompts & information</p> <p>Inspect all cables including power cord for cracks, broken or bent parts and pins, and, if applicable, paddle surfaces for pitting.</p>
<p>Task Disconnect defibrillator from AC power and wait 2 seconds. Press ON. Look for <i>SELF-TEST</i> message and illumination of LEDs.</p>	<p>User action, defibrillator labels, text/voice prompts and information</p> <p>Defibrillator turns on.</p> <ul style="list-style-type: none"> • If defibrillator doesn't turn on, contact qualified service personnel. • There should not be a <i>LOW BATTERY CONNECT TO AC POWER</i> message visible. If visible, it may mean the battery has reached its end-of-life and needs replacing.

<p>Task Confirm that the therapy cable is connected to defibrillator and perform cable checks.</p>	<p>User action, defibrillator labels, text/voice prompts & information For QUIK-COMBO cable: 1. Confirm that test plug is connected. 2. Press ANALYZE button. After <i>ANALYZING NOW</i> message, look for <i>REMOVE TEST PLUG</i> message. If <i>CONNECT CABLE</i> message appears, contact qualified service personnel. For Standard Paddles: 1. Confirm that paddles are properly seated in wells. 2. Select 10J and press CHARGE button on paddles. 3. When fully charged press  (SHOCK) buttons on paddles and look for <i>ENERGY DELIVERED</i> message. If <i>CONNECT CABLE</i> message appears, contact qualified service personnel.</p>	<p>Instructor activity Disconnect defibrillator from electricity.</p>
<p>Task Reconnect the defibrillator to AC power and turn device off.</p>	<p>User action, defibrillator labels, text/voice prompts & information Confirm <i>AC MAINS</i> LED is lit.</p>	
<p>Task Perform Manual User Test. Press ON. Note: Ignore all <i>REMOVE TEST PLUG</i> prompts and keep the test plug connected for testing. For QUIK-COMBO pads: • Confirm the QUIK-COMBO therapy cable is connected to the QUIK-COMBO test plug. • Press OPTIONS. • Select USER TEST. • Select YES to initiate user test. For Hard Paddles: • Confirm hard paddles cable is connected and paddles are seated firmly in the paddle wells. • Repeat steps above under QUIK-COMBO pads.</p>	<p>User action, defibrillator labels, text/voice prompts & information The manual user test should be performed if hospital protocol requires more frequent testing than the recommended daily auto test, or the daily auto test failed or did not complete, or if REDI-PAK™ electrodes are connected to the therapy cable. Note: If the defibrillator is in AED mode, switch to manual mode by opening the door or press the ENERGY SELECT button. Device will turn itself off after user test completed and print results. If the user test did not complete or self-tests failed, contact a qualified service personnel.</p>	<p>Instructor activity Confirm Test Plug is connected to QUIK-COMBO cable or that standard paddles are seated firmly in the paddle wells</p>
<p>Discuss Cleaning</p>	<p>User action, defibrillator labels, text/voice prompts & information Clean the LIFEPAK 20e defibrillator/monitor, cables and accessories with a damp sponge or cloth. Do not use bleach. Use only the agents listed below: • Quarternary ammonium compounds • Isopropyl alcohol • Peracetic (peroxide) acid solutions</p>	

AED operation

The AED mode on the LIFEPAK 20e defibrillator/monitor is easy to use because it automatically analyzes the patient's heart rhythm and advises you which steps to take. In AED mode the device automatically selects the appropriate energy dosing.

References to buttons are indicated in **BOLD** and display messages are indicated in *ITALICS*. For complete information, review the Operating Instructions.

Task

Verify the patient is in cardiopulmonary arrest: unconscious/unresponsive, not breathing normally, and showing no signs of circulation.

Press **ON**.

User action, defibrillator labels, text/voice prompts & information

Note the *CONNECT ELECTRODES* message and voice prompt occurs until the patient is connected to the device:

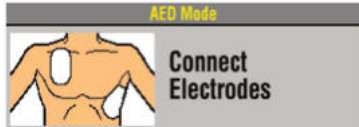

Task

Prepare the patient for therapy electrode placement.

Connect therapy electrodes to the therapy cable, and confirm cable connection to the defibrillator.

User action, defibrillator labels, text/voice prompts & information

- Bare patient's chest.
- Remove excessive chest hair.
- Clean and dry skin.
- Abrade the skin briefly using a dry towel or gauze for better electrode adhesion to the skin.
- Do not use alcohol, tincture of benzoin, or antiperspirant to prepare the skin.

Instructor activity

Connect therapy cable to the rhythm simulator and set rhythm to VF

Task

Apply therapy electrodes to patient's chest in anterior-lateral position.

Instructor activity

Confirm correct placement

Task

Press **ANALYZE** button to initiate analysis. Stop CPR.

User action, defibrillator labels, text/voice prompts & information

You will see and hear the *PUSH ANALYZE* message.

- Stop all motion including CPR.
- Do not move the LIFEPAK 20e defibrillator/monitor while analyzing.
- Clear everyone away from patient.

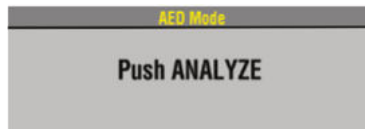

Task

Confirm everyone is clear.

Press ⚡ (Shock) button to discharge AED.

User action, defibrillator labels, text/voice prompts & information

You will see and hear *ANALYZING NOW STAND CLEAR*, The AED analyzes the patient's ECG and advises either *SHOCK ADVISED* or *NO SHOCK ADVISED*. If the AED detects a shockable rhythm, you will see and hear *SHOCK ADVISED*.

1. State "All Clear" and observe that all personnel are clear of the patient and immediate area.
2. Press ⚡ (SHOCK) button to discharge AED.

When the ⚡ is pressed, you will see Energy Delivered message indicating energy transfer was completed.

Note: When energy transfer is complete, the shock counter increases by 1. This will continue to increase incrementally with every energy transfer.

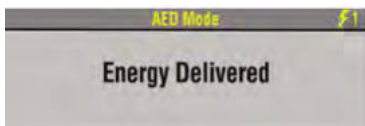

Task

START CPR.

User action, defibrillator labels, text/voice prompts & information

START CPR screen message will appear.

- A CPR timer will countdown 2 minutes or CPR time duration. A metronome automatically provides 30:2 audible compression "tocks" and ventilation prompts.

Instructor activity

Place rhythm simulator in non-shockable rhythm

Task

The CPR metronome.

The CPR metronome provides audible "tocks" that guide the user to deliver CPR with proper timing.

In AED Mode, the default C:V ratio is Adult – no airway because most patients in cardiac arrest are adults who have an initially unsecured airway. The CPR metronome can not be turned off in AED Mode.

Task

Stop CPR and push ANALYZE.

User action, defibrillator labels, text/voice prompts & information

When the CPR countdown time ends, you will see and hear *PUSH ANALYZE*.

This message stays on the screen and the voice prompt will repeat every 20 seconds until the **ANALYZE** button is pressed.

Task

Confirm everyone is clear.

User action, defibrillator labels, text/voice prompts & information

If the AED detects a nonshockable rhythm, you will see and hear *NO SHOCK ADVISED*.

Task

START CPR.

User action, defibrillator labels, text/voice prompts & information

Start CPR per voice prompt and screen message.

- A CPR timer will countdown 2 minutes.
- Continue to follow screen messages and voice prompts until the

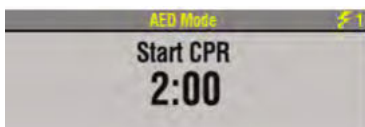

<p>Discuss Troubleshooting messages.</p>	<p>User action, defibrillator labels, text/voice prompts & information</p> <p><i>CONNECT ELECTRODES</i> message and voice prompt occur</p> <ul style="list-style-type: none"> • If therapy electrodes are not connected to the therapy cable. <p>Or</p> <ul style="list-style-type: none"> • If therapy electrodes are not placed on the patient's chest. <p><i>CONNECT CABLE</i> message occurs</p> <ul style="list-style-type: none"> • If the therapy cable is not connected to the defibrillator. <p><i>REMOVE TEST PLUG</i> message and voice prompt occurs</p> <ul style="list-style-type: none"> • If the test plug is connected to the therapy cable when analysis is initiated. Remove test plug and connect therapy electrodes to the therapy cable. <p><i>MOTION DETECTED, STOP MOTION</i> message occurs</p> <ul style="list-style-type: none"> • If motion is detected during the ECG analysis, you will see and hear <i>MOTION DETECTED, STOP MOTION</i>, followed by a warning tone. Analysis is inhibited up to 10 seconds. After 10 seconds, even if motion is still present, the analysis proceeds to completion. 	
<p>Task Switching from AED to Manual Mode. Switching from Manual Mode to AED mode.</p>	<p>User action, defibrillator labels, text/voice prompts & information</p> <ul style="list-style-type: none"> • Enter manual mode by pressing the MANUAL button located in the lower left corner of the door and opening door. <p>Or</p> <ul style="list-style-type: none"> • If there is no door, or the door is open, press ENERGY SELECT button once to switch to manual mode. • Pressing ANALYZE while the device is in manual mode will return device to AED mode. 	<p>Instructor activity</p> <p>Have students switch device between AED and manual mode and back to AED mode</p>

Manual operation

Manual training course

The manual mode training course is intended for the ALS-trained code team and reviews the manual operation and functions of the LIFEPAK 20e defibrillator/monitor. The LIFEPAK 20e defibrillator/monitor automatically converts to a manual defibrillator simply by opening a door and transitions easily to full therapy and monitoring capabilities. This training course reviews all of the advanced cardiovascular life support tools available in the LIFEPAK 20e defibrillator/monitor.

Learning objectives

The overall objective of the in-service is to provide an overview of the basic steps of operation of the identified controls, indicators, and connectors of the LIFEPAK 20e defibrillator/monitor. Upon completion of this course, participants will be able to:

- Verbalize the importance of early defibrillation.
- Locate and identify the defibrillator's front panel controls, indicators and connectors.
- Demonstrate QUIK-COMBO electrode application.
- Demonstrate steps for manual defibrillation.
- State the procedure for synchronized cardioversion.
- List the operational steps for noninvasive pacing.
- Demonstrate ECG, pulse oximetry, and EtCO₂ monitoring (if applicable).
- Describe the print process, transmitting, and recalling the code summary.
- Explain the power sources.
- Demonstrate routine daily testing.

Equipment and materials

The following is a list of accessories and support material recommended for ACLS training on the LIFEPAK 20e defibrillator/monitor. It is essential that all equipment be inspected and tested to ensure proper function prior to training.

Equipment

- LIFEPAK 20e defibrillator/monitor with Code Management Module (if applicable).

Accessories

- QUIK-COMBO therapy cable
- Test plug
- EDGE System™ electrodes with QUIK-COMBO connector (or clip-on training electrodes)
- 3-lead or 12-lead patient simulator
- 3-wire or 5-wire ECG cable
- LIFEPAK 20e defibrillator/monitor standard adult detachable hard paddles (if applicable)
- SpO₂ sensors (if applicable)
- EtCO₂ cannula and T-piece connector
- AC power cord
- 50 mm ECG printer paper

Support materials

- Quick reference cards
- Student study guide
- Operating instructions
- Performance evaluations

LIFEPAK 20e defibrillator/monitor Manual User Training Class

The following lists the content that should be covered during a typical Manual User Training Class.

- Early defibrillation
- Biphasic energy
- Controls and features
- Manual defibrillation
- Synchronized cardioversion procedure
- Noninvasive pacing
- ECG monitoring
- Pulse oximetry (if applicable)
- EtCO₂ monitoring (if applicable)
- Data management
- Device maintenance
- Other functions

Early defibrillation

A New England Journal of Medicine study of 6,789 cardiac arrest patients reported 70% received defibrillation within 2 minutes. The survival rate declined for 30% of the patients who received defibrillation more than two minutes after their cardiac arrest.¹

The American Heart Association (AHA) Guidelines for cardiopulmonary resuscitation recommended defibrillation within 2 minutes of collapse in the hospital setting. The AHA suggests hospitals deploy AEDs throughout the hospital to achieve the target time and train staff to use the AEDs.

AEDs can help your hospital staff improve their ability to deliver the first shock within the recommended 2 minute guidelines. The LIFEPAK 20e defibrillator/monitor can be used in AED mode to defibrillate without having to learn ECG interpretation. The AED is simple to use because it is designed to automatically analyze the patient's heart rhythm and advise you which steps to take. In AED mode the device automatically selects the appropriate energy dosing.

Biphasic energy

Health care providers may be confused about the right energy dose for biphasic waveforms because different defibrillator manufacturers recommend different energy dosing protocols. It is important to clarify the correct recommended energy dose for biphasic waveforms in order to avoid possible confusion that may result in a delay of therapy. ADAPTIV biphasic technology provides the option to escalate to 360J for best results. Studies show that refrillation is common among ventricular fibrillation (VF) CA patients and that defibrillation of recurring episodes of VF is increasingly difficult.^{2,3,4} LIFEPAK devices give you the option to escalate your energy dosing up to 360J for difficult to defibrillate patients.

Fortunately, all AEDs are programmed to follow a predefined energy dosing protocol. In other words, the healthcare provider doesn't have to worry about energy dosing. The AED performs this automatically.

A biphasic waveform sends current one way at the start of the shock and then reverses it so the current flows in the opposite direction. A biphasic shock is a gentler but more effective shock. Stryker recommends a dosing protocol of 200-300-360 joules and is the factory default setting in all LIFEPAK defibrillators. Stryker believes this energy protocol can help minimize unnecessary CPR interruptions that result from ineffective defibrillation shocks.

Controls and features

In this section, the goal is to point out the different buttons and physical features pertinent to an ALS user. Each of these features will be reviewed in greater detail in latter sections of this guide. For complete information, review the Operating Instructions for the device.



Area 1



Buttons

- ON
- ENERGY SELECT
- CHARGE
- ⚡ (SHOCK)
- SYNC
- ANALYZE

LED Light for AED Mode

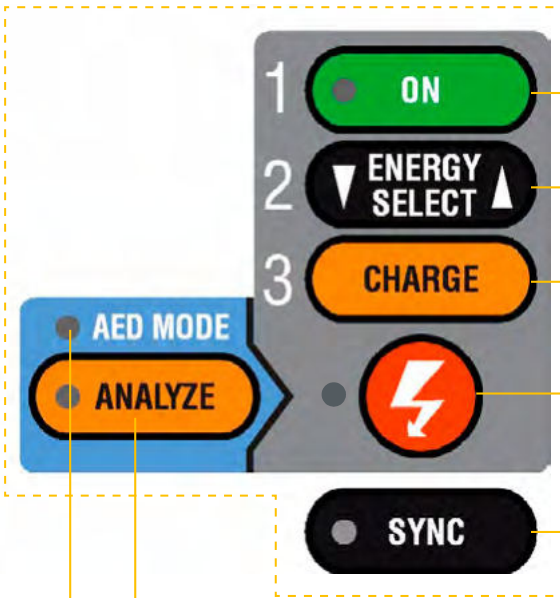

- ON**
Switches power on or off.
- ENERGY SELECT**
Selects energy levels in manual mode.
- CHARGE**
Charges the defibrillator in manual mode.
- SHOCK**
Discharges defibrillator energy to the patient.
- SYNC**
Activates synchronized mode.

ANALYZE
Activates Shock Advisory System (SAS).

AED MODE
LED illuminates when AED mode is active.

Area 2



Buttons

- PACER
- RATE
- CURRENT
- PAUSE



PACER

Activates the pacing function.

RATE

Selects pacing rate.

CURRENT

Adjusts pacing current.

PAUSE

Temporarily slows pacing rate.

Area 3



Buttons

- **EVENT**
- **LEAD**
- **SIZE**
- **ALARMS**
- **OPTIONS**
-  **(Home screen)**

LED Light for Speed Dial

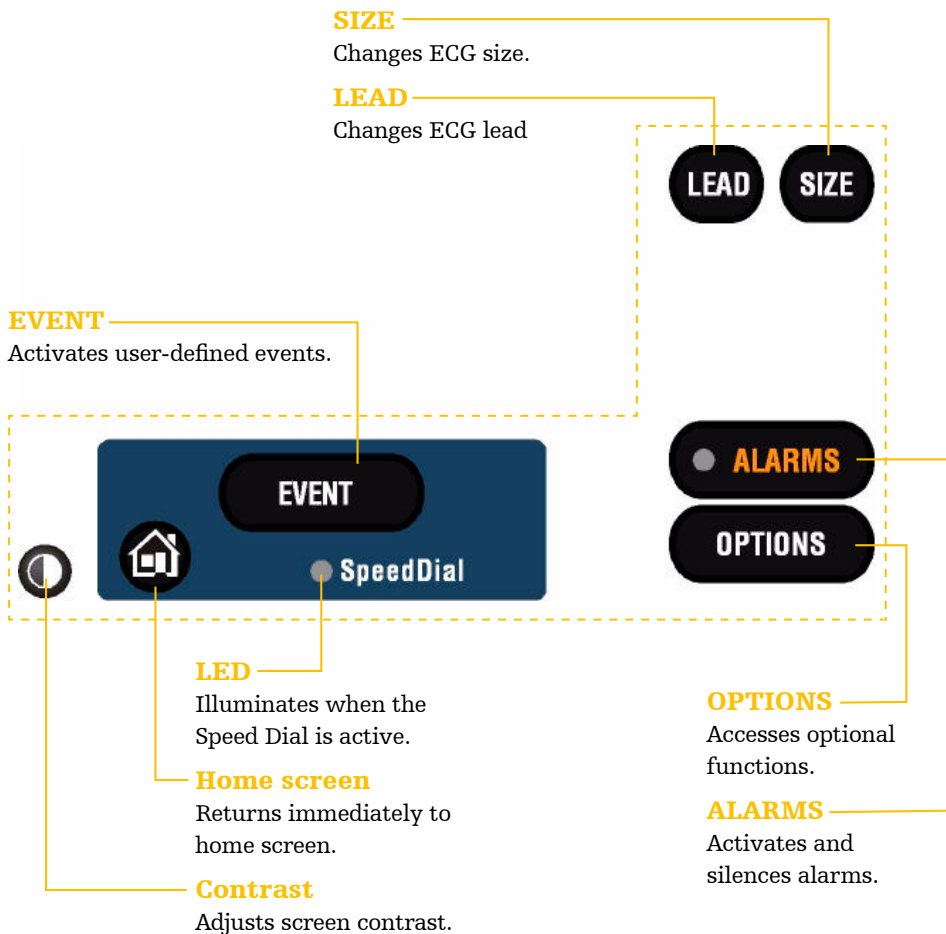

Area 4



- ECG cable connector
- SpO₂ cable connector (if applicable)
- Therapy cable connector
- Speed dial
- IrDA port
- Speaker

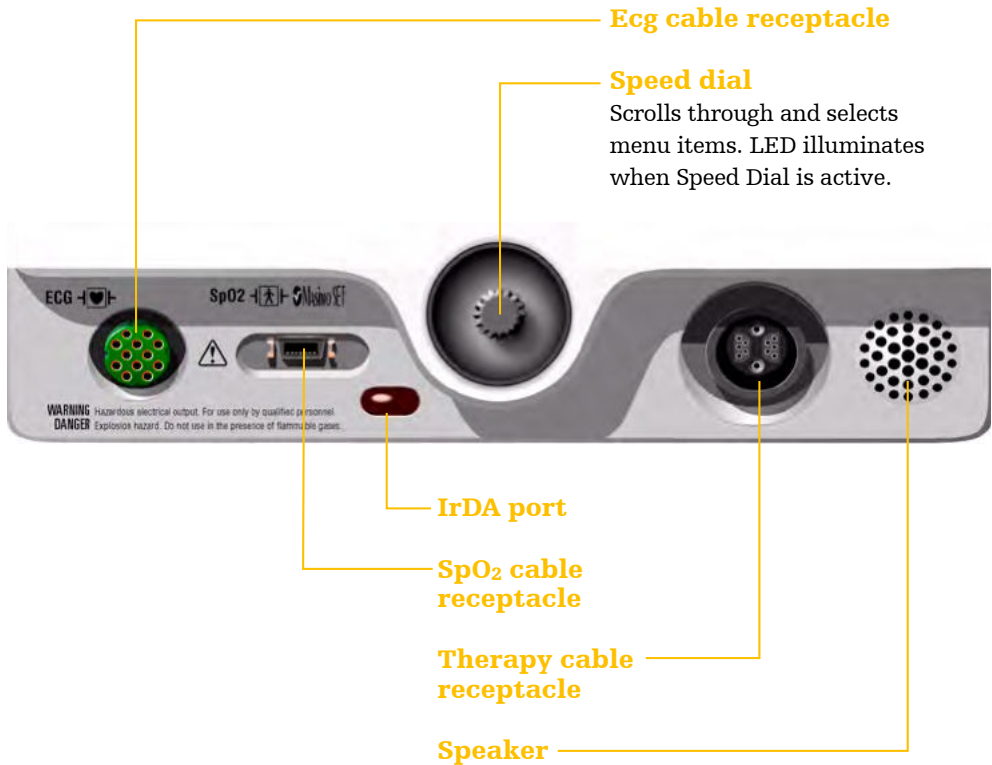

Area 5



- **PRINT**
- **CODE SUMMARY**

LED Light for AC Mains and Service

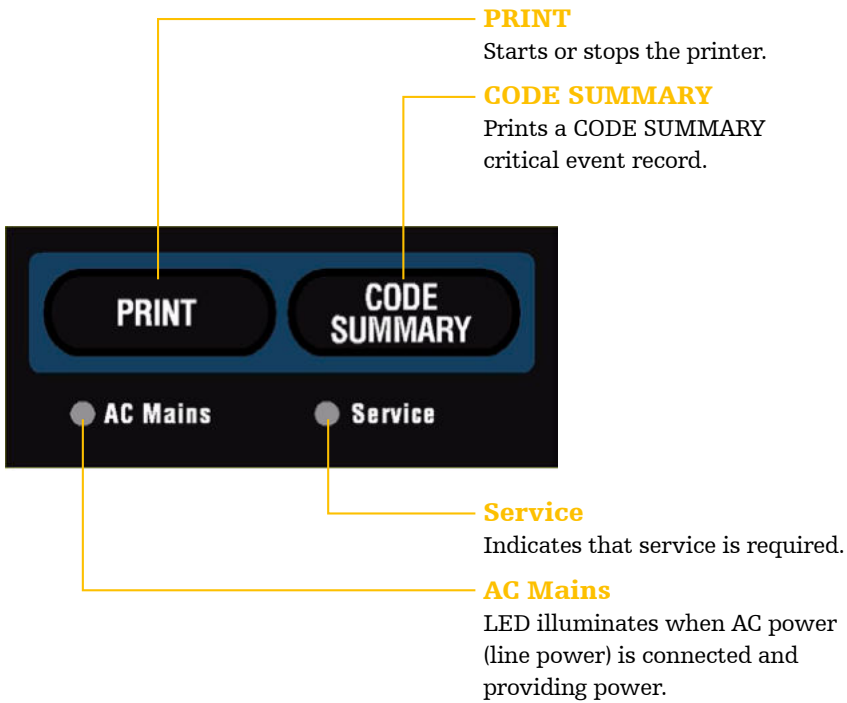

Area 4



- Power indicator
- CO₂ port



CO₂ port

Power indicator

LED illuminates when AC power (line power) is connected and providing power

Area 7



- Monitoring area
- Waveform channel area
- Status message area

Waveform channel area

Displays up to two waveform channels.

Monitoring area

Displays heart rate, time, SpO₂, battery status indicator, indicators for VF/VT alarm and selected energy.



Status message area

Displays status and alarm messages.

Additional areas not shown

Door with manual access button (if applicable)

Left side

- Printer

To load the paper:

1. Press the black button to open the printer door.
2. Remove the empty paper roll.
3. Insert the new paper roll, grid facing upward.
4. Pull out a short length of paper.
5. Push the printer door in to close.

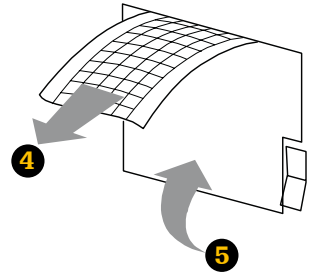
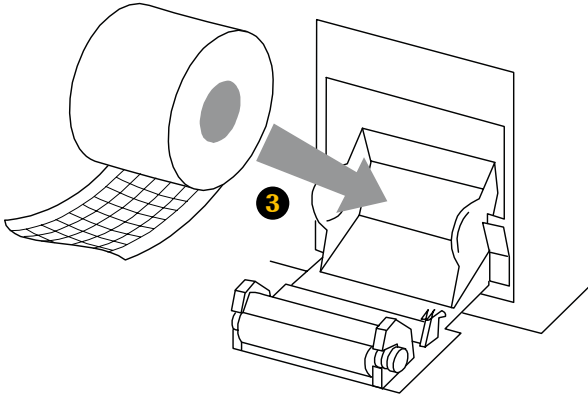
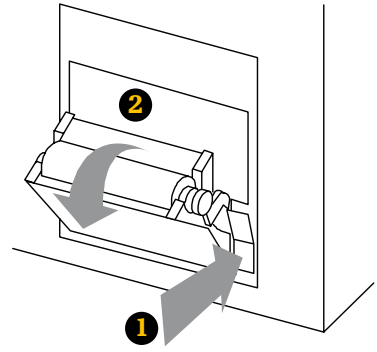

Back view with the CodeManagement Module

- AC power cord connection
- ECG/SYNC connector



Device maintenance

Most hospitals have specific protocols for maintaining their defibrillators. Stryker provides a variety of tools designed to help manage inspection and maintenance procedures. Training for staff would depend on a hospital’s particular approach.

BLS-trained responders should be familiar with several of the device maintenance procedures. How much detail you choose to go into will depend on your hospital’s protocols.

References to buttons are indicated in **BOLD** and display messages are indicated in *ITALICS*. For complete information, review the Operating Instructions for the device.

<p>Task Check defibrillator for Daily Auto Test results, if configured on.</p>	<p>User action, defibrillator labels, text/voice prompts & information</p> <ul style="list-style-type: none"> • Ensure the defibrillator is plugged in. • Ensure the therapy cable is plugged into the QUIK-COMBO test plug. <p>Or</p> <ul style="list-style-type: none"> • Ensure the standard paddles are clean, dry and properly seated in the paddle wells and connected to the defibrillator. <p>If the defibrillator detects a problem during the self-test it will remain “on” if connected to AC power and the <i>SERVICE LED</i> will illuminate and the printed report will indicate <i>SELF TEST FAILED</i>.</p> <p>If the defibrillator detects a problem while on battery power, the <i>SERVICE LED</i> will illuminate the next time it is turned on.</p> <p>Defibrillator should be checked daily following the auto test to confirm the test passed. If test failed or incomplete perform the manual user test.</p>
<p>Task Inspect the physical condition of the defibrillator.</p>	<p>User action, defibrillator labels, text/voice prompts & information</p> <p>Inspect Defibrillator for damage and foreign substances.</p>
<p>Task Inspect Power Source.</p>	<p>User action, defibrillator labels, text/voice prompts & information</p> <p>Confirm that the AC Mains LED light is on the LIFEPAK 20e defibrillator/monitor and CodeManagement Module (if applicable).</p>
<p>Task Check therapy and ECG electrodes.</p>	<p>User action, defibrillator labels, text/voice prompts & information</p> <p>Check QUIK-COMBO and EGG electrodes for “use by” date and that a spare set is available.</p>
<p>Task Examine accessory cables.</p>	<p>User action, defibrillator labels, text/voice prompts & information</p> <p>Inspect all cables including power cord for cracks, broken or bent parts and pins, and, if applicable, paddle surfaces for pitting.</p>
<p>Task Disconnect defibrillator from AC power and wait 2 seconds. Press ON. Look for <i>SELF-TEST</i> message and illumination of LEDs.</p>	<p>User action, defibrillator labels, text/voice prompts & information</p> <p>Defibrillator turns on.</p> <ul style="list-style-type: none"> • If defibrillator doesn’t turn on, contact qualified service personnel. • There should not be a <i>LOW BATTERY CONNECT TO AC POWER</i> message visible. If visible, it may mean the battery has reached its end-of-life and needs replacing.

<p>Task Confirm that the therapy cable is connected to defibrillator and perform cable checks.</p>	<p>User action, defibrillator labels, text/voice prompts & information For QUIK-COMBO cable: 1. Confirm that test plug is connected. 2. Press ANALYZE button. After <i>ANALYZING NOW</i> message, look for <i>REMOVE TEST PLUG</i> message. If <i>CONNECT CABLE</i> message appears, contact qualified service personnel. For Standard Paddles: 1. Confirm that paddles are properly seated in wells. 2. Select 10J and press CHARGE button on paddles. 3. When fully charged press ⚡ (SHOCK) buttons on paddles and look for <i>ENERGY DELIVERED</i> message. If <i>CONNECT CABLE</i> message appears, contact qualified service personnel.</p>	<p>Instructor activity Disconnect defibrillator from electricity.</p>
<p>Task Reconnect the defibrillator to AC power and turn device off.</p>	<p>User action, defibrillator labels, text/voice prompts & information Confirm that the AC Mains LED light is on the LIFEPAK 20e defibrillator/monitor and CodeManagement Module (if applicable).</p>	
<p>Task Perform Manual User Test. Press ON. Note: Ignore all <i>REMOVE TEST PLUG</i> prompts and keep the test plug connected for testing. For QUIK-COMBO pads: • Confirm the QUIK-COMBO therapy cable is connected to the QUIK-COMBO test plug. • Press OPTION. • Select USER TEST. • Select YES to initiate user test. For Hard Paddles: • Confirm hard paddles cable is connected and paddles are seated firmly in the paddle wells. • Repeat steps above under QUIK-COMBO pads.</p>	<p>User action, defibrillator labels, text/voice prompts & information The manual user test should be performed if hospital protocol requires more frequent testing than the recommended daily auto test, or the daily auto test failed or did not complete, or if REDI-PAK™ electrodes are connected to the therapy cable. Note: If the defibrillator is in AED mode, switch to manual mode by opening the door or press the ENERGY SELECT button. Device will turn itself off after user test completed and print results. If the user test did not complete or self-tests failed, contact a \qualified service personnel. Note: For additional Function Checks consult the Operating Instructions</p>	<p>Instructor activity Confirm Test Plug is connected to QUIK-COMBO cable or that standard paddles are seated firmly in the paddle wells</p>
<p>Discuss Cleaning</p>	<p>User action, defibrillator labels, text/voice prompts & information Clean the 20e defibrillator/monitor, cables and accessories with a damp sponge or cloth. Do not use bleach. Use only the agents listed below: • Quarternary ammonium compounds • Isopropyl alcohol • Peracetic (peroxide) acid solutions</p>	

Manual defibrillation

A direct current defibrillator applies a brief, intense pulse of electricity to the heart muscle. The LIFEPAK 20e defibrillator/monitor delivers this energy through disposable electrodes, standard paddles or internal paddles applied to the patient's chest. Defibrillation is only one aspect of the medical care required to resuscitate a patient with a shockable ECG rhythm. Depending on the situation, other supportive measures may include:

- High performance CPR
- Waveform capnography and ventilation support
- Drug therapy

Successful resuscitation is related to the length of time between the onset of a heart rhythm that does not circulate blood (ventricular fibrillation, pulseless ventricular tachycardia) and defibrillation. Having an AED on site and knowing CPR are so important that the American Heart Association includes both in their chain of survival. AHA recommends the chain of survival as follows:



1. Immediate **recognition** of cardiac arrest and **activation** of the emergency response system
2. Early **cardiopulmonary resuscitation (CPR)** with an emphasis on high-quality chest compressions
3. Rapid **defibrillation**
4. Effective **advanced life support**
5. Integrated **post-cardiac arrest care**

References to buttons are indicated in **BOLD** and display messages are indicated in *ITALICS*. For complete information, review the Operating Instructions for the device.

Task

Verify the patient is in cardiopulmonary arrest: unconscious/unresponsive, not breathing normally, and showing no signs of circulation after arrest.

Press **ON**.

Task

Connect therapy electrodes to the therapy cable, and confirm cable connection to the defibrillator.

Instructor activity

Connect therapy cable to the simulator and set rhythm to VF

<p>Task Prepare the patient for therapy electrode placement. Apply therapy electrodes to patient's chest in anterior-lateral position. Note: If needed, refer to anterior-lateral placement, section 4 of the Operating Instructions.</p>	<p>User action, defibrillator labels, text/voice prompts & information</p> <ul style="list-style-type: none"> • Remove all clothing from the patient's chest. • Remove excessive chest hair. • Clean and dry the skin. • Do not use alcohol, tincture of benzoin, or antiperspirant to prepare the skin. • Ensure pads are in sealed package and the use by date has not passed. • Avoid placement over the nipple, bony prominences, dressings, implantable defibrillators, or the diaphragm if possible. • Apply therapy electrodes to patient's chest in anterior-lateral position. • If using standard paddles, apply conductive gel to the electrodes and place paddles on the patient's chest. <p>Note: Impedance is measured whenever the defibrillator is charged. To ensure therapeutic patient impedance levels, you should always charge the defibrillator when the standard paddle or QUIK-COMBO electrodes are in contact with the patient's chest.</p>	<p>Instructor activity Demonstrate anterior lateral position with therapy electrodes</p>
<p>Task Press ENERGY SELECT.</p>	<p>User action, defibrillator labels, text/voice prompts & information Select joules per protocols.</p>	
<p>Task Press CHARGE. Press SPEED DIAL to disarm.</p>	<p>User action, defibrillator labels, text/voice prompts & information While the defibrillator is charging, a charging bar appears and a ramping tone sounds, indicating the charging energy level. When defibrillator is fully charged, an overlay appears.</p>	
<p>Task Make certain all personnel, including the operator, stand clear of the patient, bed, and any equipment connected to the patient. Press the  (SHOCK) button to discharge energy to the patient.</p>	<p>User action, defibrillator labels, text/voice prompts & information State "All Clear" and observe that all personnel are clear of the patient and immediate area. Confirm ECG rhythms and available energy.</p>	
<p>Discuss To change energy selection.</p>	<p>User action, defibrillator labels, text/voice prompts & information If energy selection is changed after charging has started, the energy is removed. Press CHARGE to restart charging.</p>	

Synchronized cardioversion procedure

The LIFEPAK 20e defibrillator/monitor can be configured to remain in synchronous mode or to return to asynchronous mode after discharge. It is important that you know how your defibrillator is configured.

References to buttons are indicated in **BOLD** and display messages are indicated in *ITALICS*. For complete information, review the Operating Instructions for the device.

Task

Press **ON**.

Task

Attach patient ECG cables and ECG electrodes on the patient.

Select Lead II or the lead with greatest QRS complex amplitude (positive or negative).

Observe the ECG rhythm.

Press **SYNC**.

Observe the ECG rhythm.

Prepare the patient's skin for therapy electrode application.

Connect the therapy electrodes to the therapy cable, confirm cable connect to the device.

Apply therapy electrodes to the patient in the anterior-lateral position. If using standard paddles, apply conductive gel to the paddles and place paddles on the patient's chest.

User action, defibrillator labels, text/voice prompts & information

- Bare patient's chest.
- Ensure chest is clean and dry.
- Remove excessive chest hair.
- Prepare electrode site with brisk rub.
- Ensure electrodes are in sealed package and the use by date has not passed.
- Avoid placement over the nipple, bony prominences, dressings, implantable defibrillators, or the diaphragm if possible.

Note: To monitor the ECG through therapy electrodes, place the electrodes in the anterior-lateral position and select paddles lead.

Confirm the Sync LED blinks with each detected QRS complex. Note: Press SYNC again to deactivate synchronous mode.

Confirm that a triangle sense marker appears near the middle of each QRS complex. If the sense markers do not appear or are displayed in the wrong locations (for example, on the T-wave), select another lead.

Instructor activity

Connect QUIK-COMBO Therapy Cable to the simulator and set rhythm to VT

Task

Press **ENERGY SELECT**.

User action, defibrillator labels, text/voice prompts & information

Select joules per protocols.

Task

Press **CHARGE**.

User action, defibrillator labels, text/voice prompts & information

If the *REMOVE TEST PLUG* message appears, disconnect test plug and connect therapy electrodes to QUIK-COMBO therapy cable and press **CHARGE**.

Task

Make certain all personnel, including operator, stand clear of the patient, bed, and any equipment connect to the patient.
Confirm rhythm and available energy.

Task

Press and hold  (SHOCK) button(s) until you see *ENERGY DELIVERED* on screen.

User action, defibrillator labels, text/voice prompts & information

If  (SHOCK) buttons are not pressed within 60 seconds, stored energy is internally removed.

Note: If the energy selection is changed after charging has started, the energy is removed internally. Press **CHARGE** to restart charging

Noninvasive pacing

The noninvasive pacemaker can be used for either demand (synchronous) or nondemand (asynchronous) pacing modes.

The demand mode is used for most patients. In the demand mode, the LIFEPAK 20e defibrillator/monitor/pacemaker inhibits pacing when it senses the patient's own beats, if the ECG amplitude is too low to detect the patient's beats, or if an ECG lead becomes detached so that the ECG rhythm is not present, the pacemaker generates pacing pulses asynchronously.

ECG monitoring during pacing must be performed with the ECG electrodes and patient ECG cable. Pacing therapy electrodes cannot be used to monitor ECG rhythm and deliver pacing current at the same time. Be sure to place the therapy electrodes in the proper locations as described in the pacing procedure. Improper electrode placement may make a difference in the capture threshold.

References to buttons are indicated in **BOLD** and display messages are indicated in *ITALICS*. For complete information, review the Operating Instructions for the device.

Task	Instructor activity
Press ON .	Connect QUIK-COMBO Therapy Cable to the simulator and set rhythm to bradycardia
Task Connect the patient ECG cable, apply ECG electrodes to the ECG cable and patient, and select Lead I, II, or III. Identify the QUIK-COMBO electrode sites on the patient. Prepare patient's skin for electrode application. Apply QUIK-COMBO electrodes to the patient. Connect the therapy electrodes to the therapy cable.	User action, defibrillator labels, text/voice prompts & information To receive the best monitoring signal, ensure there is adequate space between the ECG electrodes and the QUIK-COMBO electrodes. For pacing, use either the anterior-lateral or anterior-posterior position.
Task Press the PACER button. Observe the ECG rhythm.	User action, defibrillator labels, text/voice prompts & information Confirm the PACER LED illuminates, indicating that the power is on. Note: If the <i>REMOVE TEST PLUG</i> message appears, disconnect the test plug and connect therapy electrodes to QUIK-COMBO therapy cable. Confirm that a triangle sense marker appears near the middle of each QRS complex. If the sense markers do not appear or are displayed in the wrong location (i.e.: T wave) select another lead.

<p>Task Press the RATE button.</p>	<p>User action, defibrillator labels, text/voice prompts & information</p> <ul style="list-style-type: none"> • Turn <i>SPEED DIAL</i> (changes rate in increments of 5 ppm) or press RATE button (changes rate in increments of 10 ppm) to desired pacing rate. • Pacing rate range from 40 to 170 ppm. • Set rate to 80 ppm 	
<p>Task Press the CURRENT button.</p>	<p>User action, defibrillator labels, text/voice prompts & information</p> <p>Turn <i>SPEED DIAL</i> (changes current in increments of 5mA) or press CURRENT button (changes rate in increments of 10mA) to increase current until electrical capture occurs.</p> <ul style="list-style-type: none"> • For each delivered pacing stimulus, the PACER indicator flashes off and a positive pace marker displays on the ECG waveform. • Pacing current range from 0 to 200mA. • Many patients achieve capture at 50 to 100mA, although individual thresholds vary. The simulator achieves electrical capture at 65mA. 	
<p>Task Assess for mechanical capture.</p>	<p>User action, defibrillator labels, text/voice prompts & information</p> <p>Both electrical and mechanical capture must occur in order for noninvasive pacing to benefit the patient.</p> <ul style="list-style-type: none"> • Palpate patients pulse and obtain blood pressure to assess for mechanical capture. • Compare the SpO₂ pulse rate with the set pacing rate to assess for mechanical capture. • Consider use of sedation/analgesia if necessary for patient discomfort. <p>User action, defibrillator labels, text/voice prompts & information</p> <p>Note: To interrupt pacing and view the patient's intrinsic rhythm, press and hold the PAUSE button. This causes the pacer to pace at 25% of the set rate. Release the PAUSE button to resume pacing at the set rate. An ECG strip prints automatically for as long as the button is held.</p>	
<p>Task To stop pacing.</p>	<p>User action, defibrillator labels, text/voice prompts & information</p> <p>To stop pacing reduce current to zero or press PACER.</p> <p>To defibrillate and stop noninvasive pacing, press the ENERGY SELECT button or charge the defibrillator. Pacing automatically stops.</p> <p>Proceed with defibrillation.</p>	<p>Instructor activity</p> <p>Set simulator to VF and demonstrate defibrillation while pacing.</p>

<p>Discuss</p> <p>Troubleshooting</p> <ul style="list-style-type: none"> • User observation. • ECG leads off during pacing. 	<p>User action, defibrillator labels, text/voice prompts & information</p> <p>If the monitor detects ECG leads off during pacing, pacing continues at a fixed rate (nondemand pacing) until the ECG lead is reattached. During fixed-rate pacing, the pacemaker delivers pulses at the set pace rate regardless of any intrinsic beats that the patient may have. The monitor continues to display the pacing rate (ppm) and the current (mA). To reestablish demand pacing, reattach the ECG lead.</p> <p>While pacing, visually monitor the patient at all times, do not rely on the <i>ECG LEADS OFF</i> warning to detect changes in pacing function. Routinely assess the ECG for proper sensing, pace pulse delivery, electrical and mechanical capture.</p>	
<p>Task</p> <p>QUIK-COMBO electrodes off during pacing.</p>	<p>User action, defibrillator labels, text/voice prompts & information</p> <p>If the therapy electrodes detach during pacing, the <i>CONNECT ELECTRODES</i> and <i>PACING STOPPED</i> messages appear and an alarm sounds. The pacing rate is maintained and the current resets to 0mA. Reattaching the electrodes silences the alarm and removes the <i>CONNECT ELECTRODES</i> message. The current remains at 0mA until the current is increased manually.</p>	<p>Instructor activity</p> <p>Disconnect LL lead from simulator</p>

ECG monitoring

There are two methods for selecting or changing the ECG lead. Both methods are available on your LIFEPAK 20e defibrillator/monitor. The leads available depend on the ECG cable (3-wire or 5-wire) connected to the defibrillator.

References to buttons are indicated in **BOLD** and display messages are indicated in *ITALICS*. For complete information, review the Operating Instructions for the device.

Task Press ON .		
----------------------------------	--	--

Task	User action, defibrillator labels, text/voice prompts & information	Instructor activity
Attach the ECG cable to the monitor		Connect ECG cable leads to the simulator and choose a rhythm

Task Identify the appropriate electrode sites on the patient	User action, defibrillator labels, text/voice prompts & information Prepare the patient skin for electrode application: <ul style="list-style-type: none">• Remove excessive hair at electrode site. Avoid placing electrodes over tendons and major muscle masses.• For oily skin, clean skin with an alcohol pad.• Dry the site with a brisk rub.	
--	---	--

Task Apply ECG electrodes	User action, defibrillator labels, text/voice prompts & information <ul style="list-style-type: none">• Confirm package is sealed and use by date has not passed.• Attach an electrode to each lead wire.• Grasp electrode tab and peel electrode from carrier.• Inspect electrode gel for moisture content and to confirm gel is intact.• Apply the electrode flat to skin. Smooth tape outwardly. Avoid pressing the center of the electrode.• Secure the trunk cable clasp to the patient's clothing.	
-------------------------------------	--	--

Task Select the lead on the monitor screen	User action, defibrillator labels, text/voice prompts & information <ul style="list-style-type: none">• Channel 1 Top channel displays the primary ECG waveform and is always visible when ECG is displayed.• Lead options available are dependent on use of a 3 wire or 5 wire cable.• Change lead by pressing the LEAD button and select the desired lead with the SPEED DIAL. Or by pressing the LEAD button.• Adjust the ECG size by pressing the SIZE button and select the size with the SPEED DIAL, or by pressing the SIZE button.	
--	---	--

<p>Task Optional: Channel 2 waveform</p>	<p>User action, defibrillator labels, text/voice prompts & information</p> <ul style="list-style-type: none"> • This can display an additional waveform or a continuation of the Channel 1 ECG. • At the home screen, rotate the SPEED DIAL to highlight Channel 2. • Press the SPEED DIAL. An overlay appears with the monitoring choice for the selected channel. • Rotate and press the SPEED DIAL to select monitoring choice.
<p>Task Adjusting the Systole Tone Volume.</p>	<p>User action, defibrillator labels, text/voice prompts & information</p> <p>Highlight and select heart rate (HR) in the monitoring area of the screen.</p> <ul style="list-style-type: none"> • Rotate the SPEED DIAL to the desired volume. • Press the (icon) HOME SCREEN to exit.
<p>Discuss • Press PRINT to obtain an ECG printout.</p>	<p>User action, defibrillator labels, text/voice prompts & information</p> <p>Prints continuously until you press the PRINT button again to stop printing.</p>

Optional feature: Pulse oximetry

A pulse oximeter is a noninvasive tool that checks the saturation of oxygen in arterial blood (SpO₂) and is not to be used as an apnea monitor. It is used for monitoring patients who are at risk of developing hypoxemia. Pulse oximetry can be used in addition to patient assessment. If a trend toward patient deoxygenation is indicated, blood samples should be analyzed using laboratory instruments to completely understand the patient's condition.

References to buttons are indicated in **BOLD** and display messages are indicated in *ITALICS*. For complete information, review the Operating Instructions for the device.

Task Connect the SpO ₂ cable to the monitor.	User action, defibrillator labels, text/voice prompts & information Attach the sensor to the SpO ₂ cable and the patient.
Task Turn the defibrillator ON.	User action, defibrillator labels, text/voice prompts & information When the defibrillator is turned on, the oximeter turns on and performs a self-test that requires up to 10 seconds. A sleep mode is activated within 10 seconds of disconnecting the sensor. The oximeter will return to normal mode after detecting a sensor or a patient signal.
Task Observe the pulse bar for fluctuation.	User action, defibrillator labels, text/voice prompts & information Amplitude of the pulse bar indicates relative signal strength.
Task Display waveform.	User action, defibrillator labels, text/voice prompts & information <ul style="list-style-type: none">• Select waveform channel 2 using the SPEED DIAL.• Select SpO₂ from the Waveform menu.• The SpO₂ waveform automatically sizes itself to provide optimum waveform viewing.
Task Adjust SpO ₂ volume.	User action, defibrillator labels, text/voice prompts & information Highlight and select SpO ₂ on the home screen with the SPEED DIAL : <ul style="list-style-type: none">• Highlight and select SpO₂ VOLUME.• Rotate the SPEED DIAL to the desired volume.• Press the SPEED DIAL to set the volume.
Task Adjust sensitivity.	User action, defibrillator labels, text/voice prompts & information Highlight and select SpO ₂ on the home screen with the SPEED DIAL and then select <i>SENSITIVITY</i> . <ul style="list-style-type: none">• Normal sensitivity is the default.• High sensitivity allows monitoring in low perfusion states, but is more susceptible to artifact.
Task Adjust averaging time.	User action, defibrillator labels, text/voice prompts & information <ul style="list-style-type: none">• Highlight and select SpO₂ on the home screen with the SPEED DIAL and select <i>AVERAGING TIME</i>.• Turn the SPEED DIAL to select and set averaging time. Options: <ol style="list-style-type: none">1. 4 seconds (for patients with rapidly changing values)2. 8 seconds (recommended for most patients)3. 12 and 16 seconds (when artifact is affecting the performance of the pulse oximeter)

Optional feature: EtCO₂

The end-tidal CO₂ (EtCO₂) monitor is a capnometric device that uses non-dispersive infrared spectroscopy to continuously measure the amount of CO₂ during each breath and report the amount present at the end of exhalation (EtCO₂). The sample is obtained by the side stream method and can be used with intubated or nonintubated patients. Respiration rate is also measured and displayed in breaths per minute.

EtCO₂ monitoring is used to detect trends in the level of expired CO₂. It is used for monitoring breathing efficacy and treatment effectiveness in acute cardiopulmonary care, for example, to determine if adequate compressions are being performed during CPR or to rapidly detect whether an endotracheal tube has been placed successfully.

References to buttons are indicated in **BOLD** and display messages are indicated in *ITALICS*. For complete information, review the Operating Instructions for the device.

Capnography monitoring is available with the CodeManagement Module.

Discuss

To monitor EtCO₂:
Press **ON**.

User action, defibrillator labels, text/voice prompts & information

1. Select the appropriate EtCO₂ accessory for the patient.
2. Open the CO₂ port door and insert the FilterLine connector; turn connector clockwise until hand tight.
3. Verify that the CO₂ area is displayed. The EtCO₂ monitor performs the autozero routine as part of the initialization self-test.
4. Display CO₂ waveform in channel 2.
5. Connect the CO₂ FilterLine set to the patient.
6. Confirm that the EtCO₂ value and waveform are displayed. The monitor automatically selects the scale for the best visualization of the waveform.

Task

To display the EtCO₂ waveform.

User action, defibrillator labels, text/voice prompts & information

1. Rotate the **SPEED DIAL** to outline display channel 2.
2. Press the **SPEED DIAL**.
3. Select **WAVEFORM**.
4. Rotate the **SPEED DIAL** to select CO₂.
5. Press the **SPEED DIAL**.
6. Press the **HOME SCREEN** button to clear the menu.

Task

To change the CO₂ scale:

User action, defibrillator labels, text/voice prompts & information

1. Rotate the **SPEED DIAL** to outline CO₂ area.
 2. Press the **SPEED DIAL**.
 3. Select **SCALE**.
 4. Rotate the **SPEED DIAL** to select the desired scale.
 - Autoscale (default)
 - 0–20 mmHg (0–4 Vol% or kPa)
 - 0–50 mmHg (0–7 Vol% or kPa)
 - 0–100 mmHg (0–14 Vol% or kPa)
 5. Press the **SPEED DIAL** to set the scale.
 6. Press the **HOME SCREEN** button to clear the menu.
-

Data management and other functions

Data management

When you turn on the LIFEPAK 20e defibrillator/monitor, you create a new Patient Record stamped with the current date and time. All events and associated waveforms are digitally stored in the Patient Record as patient reports. When you turn the device off, the current Patient Record data is saved in the patient archives.

The Patient Record can be printed for storage in the patient’s paper file. It can also be uploaded and reviewed on a computer with CODE-STAT™ Data Review Software with Advanced CPR Analytics. This feature allows the user to collect, manage, and analyze post-event CPR performance and can help your hospital manage quality assurance and improve responder performance.

Hospitals have different approaches to managing patient data. The training for your staff will depend on your hospital’s particular approach.

References to buttons are indicated in **BOLD** and display messages are indicated in *ITALICS*. For complete information, review the Operating Instructions for the device.

<p>Task EVENT</p>	<p>User action, defibrillator labels, text/voice prompts & information</p> <p>Pressing EVENT displays a menu showing drug names or activities that may have been given or done during the defibrillator use. Use the Speed Dial to scroll through and select the menu choices. The selected event and time stamp appear in the message area on the screen and are printed in the CODE SUMMARY Event Log.</p>	
<p>Task CODE SUMMARY™ Critical Event Record</p>	<p>User action, defibrillator labels, text/voice prompts & information</p> <p>A CODE SUMMARY report is automatically stored as part of the patient record for each patient. The report consists of:</p> <ul style="list-style-type: none"> • Preamble Contains patient demographic and device information. The event identification composed of the date and time the defibrillator is turned on, is automatically entered in the ID field. • Event/Vital Signs Log Contains events and vital signs in chronological order. Events are device or operator actions that are related to the use of the defibrillator. Vital signs (HR, SpO₂ saturation, and EtCO₂ values) are entered into the log automatically every 5 minutes. • Waveform Events Therapy and other selected events also capture waveform data. Refer to the Operating Instructions for more detail. 	<p>Instructor activity</p> <p>Press CODE SUMMARY to print a code summary for the current patient.</p>
<p>Task Managing Archived Patient Records. Press OPTIONS. Select ARCHIVES.</p>	<p>User action, defibrillator labels, text/voice prompts & information</p> <p>Data Storage: When the LIFEPAK 20e defibrillator/monitor is turned on, a new patient record is created. The report is automatically stamped with the patient ID and is saved in ARCHIVES when the defibrillator is turned off.</p> <p>When Archives is entered, patient monitoring ends and the current patient record is saved and closed.</p> <ul style="list-style-type: none"> • Send Data Allows wireless transmission of patient data for selected patient (available with CodeManagement Module) • Print Allows printing of CODE SUMMARY for selected patient. • Edit Allows editing of selected fields in the patient record such as name, ID, sex, etc. • Delete Allows deletion of selected patient records. 	

Discuss

To exit *Archives*, turn off the defibrillator.

[Memory Capacity.](#)

Discuss

Uploading data to
CODE-STAT with
Advanced CPR
Analytics.

Discuss

Printing a record.

Other functions

Setup options allow you to define operating features for the LIFEPAK 20e defibrillator/monitor such as device identification numbers and default settings.

References to buttons are indicated in **BOLD** and display messages are indicated in *ITALICS*. For complete information, review the Operating Instructions for the device.

Task Setting alarms	User action, defibrillator labels, text/voice prompts & information <ul style="list-style-type: none">• Press ALARMS.• Select QUICK SET to activate the alarms for all active parameters (HR, SpO₂, and EtCO₂ if applicable).• Select LIMITS to set or change the alarm limits to WIDE or NARROW.• Limits are set based on the patient's current HR and SpO₂ saturation.• Select SUSPEND to turn off the audible alarm tone for up to 15 minutes.• Select VF/VT ALARM to turn on continuous monitoring for ventricular fibrillation and ventricular tachycardia in manual mode.• A symbol (magnifying glass) appears above the primary ECG when the alarm is on.
Task Managing alarms	User action, defibrillator labels, text/voice prompts & information <ul style="list-style-type: none">• The alarm bell symbol indicates when alarms are ON or OFF. When Alarms are OFF a red X appears over the bell.• When alarms are on and an alarm limit is exceeded, a tone sounds, the violated parameter flashes, and an alarm message appears. To manage an alarm: <ul style="list-style-type: none">• Press ALARMS. This silences the alarm tone for 2 minutes.• Assess the cause of the alarm.• Assess the appropriateness of the limits setting (WIDE or NARROW).• If the patient is unstable, consider suspending the alarm tone for up to 15 minutes. Do not reselect QUICK SET.• Once the patient is stable reselect QUICK SET if necessary.
Task Options	User action, defibrillator labels, text/voice prompts & information <p>Pressing OPTIONS displays a menu showing the following items. Use the Speed Dial to scroll through and select the menu choices.</p> <ul style="list-style-type: none">• PATIENT Allows entering of patient demographic information into the patient record.• PACING Selects demand or nondemand pacing and internal pacer detection on or off.• PRINT Allows printing of CODE SUMMARY reports.• ARCHIVES Accesses archived patient records.• DATE/TIME Sets the date and time. For changes to take effect, cycle power.• ALARM VOLUME Adjusts volume for alarms, tones, and voice prompts.

LIFEPAK® 20e Defibrillator/Monitor with and without CodeManagement Module®

BRIEF SUMMARY OF INDICATIONS AND IMPORTANT SAFETY INFORMATION

LIFEPAK 20e defibrillator/monitor is an acute cardiac care response system intended for use by authorized healthcare providers in hospital and clinic settings. It is to be used on one patient at a time. LIFEPAK 20e is intended for use by personnel who have been trained in its operation. **AED MODE. Indications for Use:** To be used only on patients in cardiopulmonary arrest. Patient must be unconscious, pulseless, and not breathing normally before using defibrillator to analyze patient's ECG rhythm. In AED mode, LIFEPAK 20e is not intended for use on pediatric patients less than 8 years old. **Contraindications:** None known. **Operator Considerations:** In AED mode, LIFEPAK 20e is intended for use by personnel authorized by physician/medical director and have, at a minimum, the following: CPR training, AED training equivalent to that recommended by AHA, and training in use of LIFEPAK 20e in AED mode. **DEFIBRILLATION THERAPY. Indications for Use:** Defibrillation is a recognized means of terminating certain potentially fatal arrhythmias, such as VF and symptomatic VT. Delivery of this energy in synchronized mode is a method for treating AF, atrial flutter, paroxysmal supraventricular tachycardia, and, in relatively stable patients, VT. **Contraindications:** Treatment of PEA such as idioventricular or ventricular escape rhythms, and in treatment of asystole. **Operator Considerations:** LIFEPAK 20e delivers energy through disposable electrodes, standard paddles applied to a patient's chest, or internal paddles applied directly to the patient's heart. Defibrillation is only one aspect of medical care required to resuscitate patient with shockable ECG rhythm. Other supportive measures may include CPR, administration of supplemental oxygen and drug therapy. **NONINVASIVE PACING. Indications for Use:** For symptomatic bradycardia in patients with pulse. **Contraindications:** Treatment of VF and asystole. **SPO₂ MONITORING. Indications for Use:** Pulse oximeter is for use in patient at risk of developing hypoxemia. **Contraindications:** None known. **EtCO₂ MONITORING. Indications for Use:** To detect the level of expired CO₂, used for monitoring breathing efficacy and treatment effectiveness in acute cardiopulmonary care, for example, to determine if adequate compressions are being performed during CPR or rapidly detect whether endotracheal tube has been placed successfully. **Contraindications:** None known. **LIFEPAK 20e with or without CodeManagement Module – ECG MONITORING:** ECG obtained by placing either electrodes or paddles on patient; allows for heart's electrical activity to be monitored and recorded.

Operating Instructions provide important information to help you operate LIFEPAK 20e and CodeManagement Module. Become familiar with all terms, warnings, and symbols. GENERAL/MANUAL DEFIBRILLATION/PADDLE WARNINGS and CAUTIONS: Shock or fire hazards • Possible explosion • Possible patient skin burns • Possible device or paddle damage. • Possible device failure, inability to deliver therapy, ineffective energy delivery, shutdown, or improper device performance • Possible electrical interference with device performance, implanted electrical device or other equipment • Safety risk • Failure to detect change in ECG rhythm • Possible failure to detect out of range condition. **AED WARNINGS:** Possible misinterpretation of data • Pediatric patient safety risk. **ECG MONITORING WARNING:** Possible misinterpretation of ECG data. **PEDIATRIC ECG MONITORING AND THERAPY PROCEDURES:** Possible patient skin burns. **SYNCHRONIZED CARDIOVERSION WARNING:** Possible lethal arrhythmia. • Possible monitor incompatibility. **REMOTE SYNCHRONIZATION:** Possible lethal arrhythmia • Possible monitor incompatibility. **CPR METRONOME WARNING:** CPR delivered when not needed. **NONINVASIVE PACING WARNINGS:** Possible inducement of VF • Possible inability to pace • Possible interruption of therapy • Possible patient skin burns. **SPO₂ WARNINGS AND CAUTION:** Shock or burn hazard • Inaccurate pulse oximeter readings • Skin injury • Possible strangulation • Possible equipment damage. **EtCO₂ MONITORING WARNINGS AND CAUTION:** Fire hazard • Possible inaccurate patient assessment or inaccurate CO₂ readings • Possible strangulation • Infection hazard • Possible equipment damage. **CODEMANAGEMENT MODULE BATTERY WARNING:** Possible CO₂ monitoring shutdown. **REPLACING/REMOVING ELECTRODES WARNING:** Possible cable damage and ineffective energy delivery or loss of monitoring.

U.S. Federal law restricts this device to sale by or on the order of a physician.

Please consult Operating Instructions at www.physio-control.com or call 800.442.1142 for complete list of indications, contraindications, warnings, cautions, potential adverse events, safety and effectiveness data, instructions for use and other important information.

References

1. Chan PS, Krumholz HM, Nichol G, Nallamothu BK. "Delayed time to defibrillation after in-hospital cardiac arrest." *NEJM*. 2008;358:9–17.
2. Stiell IG, Walker RG, Nesbitt LP, et al. "The BIPHASIC Trial: A randomized comparison of fixed lower versus escalating higher energy levels for defibrillation in out-of-hospital cardiac arrest." *Circulation*. 2007;115:1511–1517.
3. Koster RW, Walker RG, Chapman F. "Recurrent ventricular fibrillation during advanced life support care of patients with prehospital cardiac arrest." *Resuscitation*. 2008;78:252–257.
4. Walsh SJ, McClelland AJ, Owens CG, et al. "Efficacy of distinct energy delivery protocols comparing two biphasic defibrillators for cardiac arrest." *Am J Cardiology*. 2004;94:378–380.

For further information, please contact your Stryker representative or visit our website at strykeremergencycare.com

Emergency Care

This document is intended solely for the use of healthcare professionals. A healthcare professional must always rely on his or her own professional clinical judgment when deciding whether to use a particular product when treating a particular patient. Stryker does not dispense medical advice and recommends that healthcare professionals be trained in the use of any particular product before using it.

The information presented is intended to demonstrate Stryker's product offerings. A healthcare professional must always refer to operating instructions for complete directions for use indications, contraindications, warnings, cautions, and potential adverse events, before using any of Stryker's products. Products may not be available in all markets because product availability is subject to the regulatory and/or medical practices in individual markets. Please contact your representative if you have questions about the availability of Stryker's products in your area. Specifications subject to change without notice.

Stryker or its affiliated entities own, use, or have applied for the following trademarks or service marks: CodeManagement Module, CODE-STAT, CODE SUMMARY, EDGE System, LIFEPAK, QUIK-COMBO, REDI-PAK, Stryker. All other trademarks are trademarks of their respective owners or holders.

The absence of a product, feature, or service name, or logo from this list does not constitute a waiver of Stryker's trademark or other intellectual property rights concerning that name or logo.

03/2021

GDR 3302004_F

Copyright © 2021 Stryker

Manufactured by:

Physio-Control, Inc.
11811 Willows Road NE
Redmond, WA, 98052 U.S.A.
Toll free 800 442 1142
strykeremergencycare.com

Stryker European
Operations B.V.
Herikerbergweg 110
1101 CM Amsterdam
Netherlands
Tel +31 (0)43 3620008
Fax +31 (0)43 3632001

Distributed by:

Stryker Canada
2 Medicorum Place
Waterdown, Ontario
L8B 1W2
Canada
Toll free 800 668 8323

Stryker UK Ltd
Stryker House
Hambridge Road
Newbury, Berkshire
RG14 5AW
United Kingdom [Back to contents](#)