

LIFEPAK® 12 DEFIBRILLATOR/MONITOR

OPERATING INSTRUCTIONS



LIFEPAK[®] 12 DEFIBRILLATOR/MONITOR

OPERATING INSTRUCTIONS

IMPORTANT INFORMATION

!USA Rx Only

Device Tracking

!USA The U.S. Food and Drug Administration requires defibrillator manufacturers and distributors to track the location of their defibrillators. If the device is located somewhere other than the shipping address or the device has been sold, donated, lost, stolen, exported, destroyed, permanently retired from use, or if the device was not obtained directly from Physio-Control, please do one of the following: register the device at <http://www.physio-control.com>, call the device tracking coordinator at 1.800.426.4448, or use one of the postage-paid address change cards located in the back of this manual to update this vital tracking information.

Responsibility for Information

It is the responsibility of our customers to ensure that the appropriate person(s) within their organization have access to this information, including general safety information provided in Section 1.

Version History

These operating instructions describe LIFEPAK 12 defibrillator/monitor devices with software version 3011371-065 or later. Older devices may not have all the features described in this manual. Software version 3011371-106 or later will not work in monophasic devices.

Operating Instructions Version	Operating Software Version*
PN 3010012-000	PN 3011371-018
PN 3010012-001	PN 3011371-019 and PN 3011371-022
PN 3010012-003	PN 3011371-030
PN 3010012 (-005 international; -006 USA only)	PN 3011371-061
PN 3010012-007 (USA only)	PN 3011371-062
PN 3012730-000 (addendum)	PN 3011371-065
PN 3010012 (-008 and -009 USA only; -050 international)	PN 3011371-065
PN 3010012 (-010 and -011 USA only; -051 international)	PN 3011371-067, -070
PN 3010012 (-012 and -013 USA only; -052 international)	PN 3011371-072
PN 3010012 (-014 USA only; -053 international)	PN 3011371-072
PN 3010012 (-015 USA only; -020 international)	PN 3011371-090
PN 3010012 (-016 USA only; -021 international)	PN 3011371-099
MIN 3010012 (-017 USA only; -022 international)	MIN 3011371-101
MIN 3010012 (-018 USA only; -023 international)	MIN 3011371-106
MIN 3010012 (-019 USA only; -024 international)	MIN 3011371-106
MIN 3207254 (-001 USA only; -021 international)	MIN 3011371-126
MIN 3207254 (-002 USA only; -022 international)	MIN 3011371-130
MIN 3207254 (-006 USA only; -026 international)	MIN 3011371-134
MIN 3207254 (-007 USA only; -027 international)	MIN 3011371-134

* To view the operating software version, turn on the device and note the PN after VERSION on the opening screen.



LIFEPAK, LIFEPAK, FASTPAK, FAST-PATCH, QUIK-COMBO, QUIK-LOOK, and QUIK-CHARGE are registered trademarks of Physio-Control, Inc. CODE SUMMARY, Shock Advisory System, CODE-STAT, cprMAX, and REDI-PAK are trademarks of Physio-Control, Inc. CADEX is a registered trademark of Cadex Electronics Inc. 12SL is a trademark of GE Medical Systems. C-LOCK, Dura-Y, Durasensor, Nellcor, Oxiband, OxCliq, and Oxisensor are registered trademarks of Nellcor. PediCheck is a trademark of Nellcor. Microstream and FilterLine are trademarks of Orion Medical Ltd. The Orion medical capnography in this product is covered by one or more of the following US patents: 6,428,483; 6,997,880; 5,300,859; 6,437,316 and their foreign equivalents. Additional patent applications pending. PC Card is a trademark of the Personal Computer Memory Card International Association. Masimo and LNOP are registered trademarks of Masimo Corporation. EDGE System Technology is a trademark of Ludlow Technical Products. UNI-LEAD is a trademark of Unilead International, Inc. DTXPlus is a trademark of BD Medical. Specifications are subject to change without notice.
© 2008-2015 Physio-Control, Inc. All rights reserved.



Publication date: 08/2015

MIN 3207254-013

TABLE OF CONTENTS

Preface

About Automated External Defibrillation	x
About Defibrillation Therapy	x
About Noninvasive Pacing	xi
About 12-Lead Electrocardiography.....	xi
About SpO2 Monitoring.....	xii
About NIBP Monitoring.....	xii
About End-Tidal CO2 (EtCO2) Monitoring	xiii
About Invasive Pressure (IP) Monitoring.....	xiii
About Vital Sign and ST Monitoring	xiii
About ECG Monitoring	xiii
Text Conventions	xiv

1 Safety Information

Terms	1-2
General Warnings and Cautions	1-2
Symbols	1-3

2 Basic Orientation

Introduction	2-2
Unpacking and Inspecting.....	2-3
Controls, Indicators, and Connectors.....	2-3
Area 3	2-8
Area 4	2-11
Area 6	2-15
Back View	2-19
Entering Patient Data.....	2-20
Setting Alarms.....	2-22
Managing Alarms	2-24
Connecting to Power.....	2-25
Batteries.....	2-25
Understanding Batteries and Battery Support Systems.....	2-25
Installing/Removing Batteries	2-28

3 Monitoring

Monitoring the ECG	3-2
ECG Monitoring Warning.....	3-2
Selecting ECG Lead and Size	3-2
Adjusting the Systole Volume	3-4
Monitoring ECG with Paddles Accessories	3-4
Monitoring with the Patient ECG Cable	3-5
Troubleshooting Tips for ECG Monitoring	3-8
Acquiring a 12-Lead ECG	3-9
12-Lead ECG Warning	3-9
Identifying Electrode Sites	3-9
12-Lead ECG Procedure	3-11
12-Lead ECG Reports	3-12
Computerized ECG analysis.....	3-14
Troubleshooting Tips for 12-Lead ECG	3-15
Monitoring SpO2	3-16
SpO2 Warnings and Cautions	3-16
No Implied License	3-17
When to Use a Pulse Oximeter	3-17
How a Pulse Oximeter Works.....	3-17
SpO2 Monitoring Considerations.....	3-18
Masimo SpO2 Monitoring Procedure.....	3-18
Nellcor SpO2 Monitoring Procedure	3-20
Cleaning.....	3-22
Troubleshooting Tips for SpO2.....	3-23
Monitoring Noninvasive Blood Pressure (NIBP)	3-24
NIBP Monitoring Warnings	3-24
When to Use NIBP.....	3-25
How NIBP Works.....	3-25
NIBP Monitoring Considerations.....	3-26
Cuff Selection	3-26
NIBP Monitoring Procedures	3-26
Changing the Initial Inflation Pressure	3-26
Manual Single-Measurement Procedure	3-27
Timer-Controlled Measurement Procedure	3-27
Cleaning and Maintenance	3-28
Troubleshooting Tips for NIBP Monitoring.....	3-28
Monitoring EtCO2	3-29
EtCO2 Monitoring Warnings.....	3-30
When to Use EtCO2 Monitoring	3-30
How Capnography Works.....	3-30
EtCO2 Monitoring Waveform Analysis	3-31
EtCO2 Monitoring Procedure.....	3-32
CO2 Scale Options.....	3-33
CO2 Alarms	3-33
Cleaning and Maintenance	3-33
Troubleshooting Tips for EtCO2 Monitoring	3-34
Monitoring Invasive Pressure (IP).....	3-35
IP Monitoring Warnings	3-35
When to Use IP.....	3-35
How IP Works.....	3-36
IP Monitoring Considerations.....	3-36
IP Monitoring Procedure	3-36
Cleaning and Maintenance	3-37
Troubleshooting Tips for IP Monitoring.....	3-37
Monitoring Vital Signs (VS) and ST Changes	3-39
VS and ST Monitoring Warning	3-39

When to Use VS and ST Monitoring	3-39
How VS and ST Monitoring Work.....	3-40
VS and ST Monitoring Considerations	3-41
VS and ST Monitoring Procedure.....	3-41

4 Therapy

General Therapy Warnings and Cautions	4-2
Therapy Electrode and Standard Paddle Placement	4-3
Anterior-lateral Placement.....	4-3
Anterior-posterior Placement.....	4-3
Automated External Defibrillation	4-4
AED Warnings.....	4-4
AED Configuration.....	4-4
AED Procedure	4-4
Special AED Setup Options	4-9
Advisory Monitoring.....	4-11
Troubleshooting Tips for AED Mode	4-12
Manual Defibrillation	4-13
Manual Defibrillation Warnings.....	4-13
Switching from AED to Manual Mode.....	4-13
Defibrillation Shock Overlays	4-14
Defibrillation Procedure	4-15
Synchronized Cardioversion Procedure.....	4-16
Troubleshooting Tips for Defibrillation and Synchronized Cardioversion	4-17
Noninvasive Pacing	4-18
Noninvasive Pacing Warnings.....	4-18
Demand and Nondemand Pacing	4-19
Noninvasive Pacing Procedure	4-19
Troubleshooting Tips for Noninvasive Pacing	4-20

5 Paddle Accessory Options

Therapy Electrodes	5-2
About Therapy Electrodes.....	5-2
Electrode Placement	5-3
Cable Connection.....	5-4
ECG Monitoring and Therapy Procedures	5-4
Replacing and Removing Electrodes	5-5
Testing.....	5-6
Cleaning and Sterilizing.....	5-6
Pediatric Paddles (PN 800418)	5-6
About Pediatric Paddles	5-6
Attaching Pediatric Paddles	5-6
Removing Pediatric Paddles	5-7
Paddle Placement	5-7
Defibrillation Procedure	5-8
Cleaning	5-9
Sterilizable Internal Defibrillation Paddles	5-9

6 Data Management

Overview of Data Storage and Retrieval	6-2
Data Storage	6-2
Report Types.....	6-2
Memory Capacity	6-2
Report Retrieval	6-2
CODE SUMMARY Report	6-3
Preamble	6-4
Event/Vital Signs Log	6-4

Waveform Events	6-5
CODE SUMMARY Format.....	6-5
Managing Current Patient Records.....	6-7
Transmitting a Current Patient Report	6-7
Printing a Current Patient Report.....	6-9
Managing Archived Patient Records.....	6-11
Transmitting Archived Patient Reports	6-11
Printing Archived Patient Reports	6-15
Editing Archived Patient Records	6-17
Deleting Archived Patient Records	6-18
Overview of Connections for Transmitting Reports	6-20
Equipment Connections for Internal Modem – Analog Cellular	6-20
Equipment Connections for Internal Modem – Analog Landline.....	6-22
Equipment Connections for External Modem – Analog Landline.....	6-23
Equipment Connections for Direct Connect.....	6-24
Treatment Protocol When Transmitting Data or Fax	6-24
Fax Report Format.....	6-25
Troubleshooting Tips for Data Management.....	6-26

7 Power Adapter

Basic Orientation.....	7-2
Power Adapter Warnings.....	7-2
Unpacking and Inspecting	7-3
Controls, Indicators, and Connectors	7-4
Using the AC Power Adapter	7-5
AC Power Adapter Operation	7-5
Mounting the Power Adapter to the LIFEPAK 12 Defibrillator/Monitor	7-6
General Maintenance.....	7-7
Maintenance and Service	7-7
Cleaning.....	7-7
Fuse Replacement.....	7-7
Troubleshooting	7-8
Warranty	7-8
Replacement Parts and Accessories.....	7-9

8 Maintaining the Equipment

General Maintenance and Testing.....	8-2
Maintenance and Testing Schedule	8-2
User Test	8-3
Standard Paddles User Test.....	8-3
Cleaning.....	8-4
Function Checks	8-4
Battery Maintenance	8-8
Battery Maintenance Warnings.....	8-8
Battery Description	8-8
Battery Charging, Conditioning, and Shelf Life Testing.....	8-9
NiCd Battery Performance Factors.....	8-9
SLA Battery Performance Factors	8-10
Receiving New Batteries.....	8-11
Storing Batteries	8-11
Recycling Batteries at the End of Useful Life.....	8-11
General Troubleshooting Tips	8-12
Service and Repair	8-13
Product Recycling Information	8-14
Recycling Assistance.....	8-14
Preparation	8-14
Recycling of Disposable Electrodes	8-14

Packaging.....	8-14
Warranty.....	8-14
Accessories, Supplies, and Training Tools.....	8-14

9 Defining Setup Options

Setup Options.....	9-2
Print Configurations Before Service or Repair.....	9-2
Passcode Security.....	9-2
Entering Setup Options	9-3
General Setup Menu	9-3
Manual Mode Setup Menu	9-4
AED Mode Setup Menu.....	9-5
Pacing Setup Menu	9-7
Monitoring Menu.....	9-7
Channels Setup Menu.....	9-8
Waveform Sets Setup Menu	9-8
CO2 Setup Menu.....	9-8
NIBP Setup Menu.....	9-8
12-Lead Setup Menu.....	9-9
Events Setup Menu	9-9
Alarms Setup Menu	9-10
Printer Setup Menu.....	9-10
Auto Print Setup Menu	9-11
Transmission Setup Menu.....	9-11
Transmission/Data Setup Menu	9-11
Transmission/Fax Setup Menu.....	9-14
Clock Setup Menu	9-17
Reset Defaults Setup Menu.....	9-17
Print Defaults	9-18
Send Configuration Setup Menu	9-18
Set Passcode Setup Menu	9-18
Service Mode.....	9-18
Entering Telephone Number and Prefix Characters.....	9-19
Setting Up Transmit Sites.....	9-19

A Specifications and Performance Characteristics

B Screen Messages

C Operator's Checklist

D Shock Advisory System

E Inservice Mode

F International Transmit Connections

G About cprMAX Technology

H Electromagnetic Compatibility Guidance

Index

PREFACE

About Automated External Defibrillation	page x
About Defibrillation Therapy	x
About Noninvasive Pacing	xi
About 12-Lead Electrocardiography	xi
About SpO2 Monitoring	xii
About NIBP Monitoring	xii
About End-Tidal CO2 (EtCO2) Monitoring	xiii
About Invasive Pressure (IP) Monitoring	xiii
About Vital Sign and ST Monitoring	xiii
About ECG Monitoring	xiii
Text Conventions	xiv

ABOUT AUTOMATED EXTERNAL DEFIBRILLATION

The following considerations and guidelines apply when using the LIFEPAK 12 defibrillator/monitor as an automated external defibrillator (AED).

Operator Considerations

The LIFEPAK 12 defibrillator/monitor, when in AED mode, is a semiautomatic defibrillator that uses a patented Shock Advisory System™. This software algorithm analyzes the patient's electrocardiographic (ECG) rhythm and indicates whether or not it detects a shockable rhythm. The LIFEPAK 12 defibrillator/monitor in AED mode requires operator interaction in order to defibrillate the patient.

The LIFEPAK 12 defibrillator/monitor in AED mode is intended for use by personnel who are authorized by a physician/medical director and have, at a minimum, the following skills and training:

- CPR training.
- AED training equivalent to that recommended by the American Heart Association.
- Training in the use of the LIFEPAK 12 defibrillator/monitor in AED mode.

Indications

The AED mode is to be used only on patients in cardiopulmonary arrest. The patient must be unconscious, pulseless, and not breathing normally before using the defibrillator to analyze the patient's ECG rhythm. In AED mode, the LIFEPAK 12 defibrillator/monitor is not intended for use on pediatric patients less than 8 years old.

Contraindications

None known.

ABOUT DEFIBRILLATION THERAPY

A direct current defibrillator applies a brief, intense pulse of electricity to the heart muscle. The LIFEPAK 12 defibrillator/monitor delivers this energy through disposable electrodes or standard paddles applied to the patient's chest.

Defibrillation is only one aspect of the medical care required to resuscitate a patient with a shockable ECG rhythm. Depending on the situation, other supportive measures may include:

- Cardiopulmonary resuscitation (CPR)
- Administration of supplemental oxygen
- Drug therapy

Successful resuscitation is related to the length of time between the onset of a heart rhythm that does not circulate blood (ventricular fibrillation, pulseless ventricular tachycardia) and defibrillation. The American Heart Association has identified the following as critical links in the chain of survival from cardiac arrest:

- Early access
- Early CPR by first responders or bystanders
- Early defibrillation
- Early advanced life support

The physiological state of the patient may affect the likelihood of successful defibrillation. Thus, failure to resuscitate a patient is not a reliable indicator of defibrillator performance. Patients will often exhibit a muscular response (such as jumping or twitching) during an energy transfer. The absence of such a response is not a reliable indicator of actual energy delivery or device performance. For further information, refer to the booklet, *Defibrillation: What You Should Know*.

The biphasic defibrillation waveform used in this device has been clinically tested only on adults; it has not been tested on pediatric patients.

Indications

Defibrillation is indicated for the termination of certain potentially fatal arrhythmias, such as ventricular fibrillation and symptomatic ventricular tachycardia. Energy delivered in the synchronized mode is a method for treating atrial fibrillation, atrial flutter, paroxysmal supraventricular tachycardia, and, in relatively stable patients, ventricular tachycardia.

Contraindications

Defibrillation is contraindicated in the treatment of Pulseless Electrical Activity (PEA), such as idioventricular or ventricular escape rhythms, and in the treatment of asystole.

ABOUT NONINVASIVE PACING

A noninvasive pacemaker is a device that delivers an electrical stimulus to the heart, causing cardiac depolarization and myocardial contraction. The energy is delivered through large adhesive electrodes placed on the chest. In addition to noninvasive pacing, other supportive measures may be necessary. Among other factors, it is recognized that successful pacing of a patient is related to the length of time between the onset of a dysrhythmia and the initiation of pacing. Rapid pacing and prompt follow-up care are essential. The physiologic state of the patient may affect the likelihood of successful pacing or of skeletal muscle activity. The failure to successfully pace a patient is not a reliable indicator of pacemaker performance. Similarly, the patient's muscular response to pacing is not a reliable indicator of energy delivered. Refer to the booklet, *Noninvasive Pacing: What You Should Know*, for further information.

Indications

Noninvasive pacing is indicated for symptomatic bradycardia in patients with a pulse.

Contraindications

Noninvasive pacing is contraindicated for the treatment of ventricular fibrillation and asystole.

ABOUT 12-LEAD ELECTROCARDIOGRAPHY

The 12-lead electrocardiogram (ECG) has traditionally been used in the hospital setting to help physicians identify, diagnose, and treat patients with cardiac disorders. Advances in technology now make acquiring and transmitting 12-lead ECGs in the prehospital setting both feasible and beneficial. Prehospital 12-lead ECG with computer analysis and transmission to the emergency department is recommended by the American Heart Association (AHA) and the National Heart Attack Alert Program (NHAAP) for patients with chest pain and possible acute myocardial infarction (AMI). The LIFEPAK 12 defibrillator/monitor incorporates the GE Medical Systems 12SL™ ECG analysis program and the Reperfusion Advisory Algorithm developed by Dr. Simoons (available outside the USA only). The Reperfusion Advisory Algorithm is not intended for use on pediatric patients.

A 12-lead ECG is useful in the early detection and prompt treatment of patients with acute myocardial infarction. When transmitted from the field, the procedure has been shown to shorten time to in-hospital treatment by roughly 10 to 60 minutes. Patients may also benefit from triage and transport to the most appropriate facility. Documentation of transient or intermittent arrhythmias and other electrophysiologic events that occur in the prehospital setting can assist in diagnosis and treatment decisions in the ED.

The prehospital 12-lead ECG offers paramedics and emergency physicians significant advantages over the single lead cardiac typically available in EMS. The prehospital 12-lead ECG not only provides a diagnostic quality ECG for use in the detection of AMI, but also allows the knowledgeable paramedic to determine the area of myocardial injury, anticipate associated potential complications, and

implement treatment strategies accordingly. In addition, the prehospital 12-lead ECG provides a baseline for serial ECG evaluations. For further information, refer to the booklet, *Prehospital 12-Lead ECG: What You Should Know*.

Indications

The 12-lead electrocardiogram is used to identify, diagnose and treat patients with cardiac disorders and is useful in the early detection and prompt treatment of patients with acute myocardial infarction.

Contraindications

None known.

ABOUT SPO2 MONITORING

A pulse oximeter is a noninvasive device that checks the saturation of oxygen in arterial blood (SpO₂). The pulse oximeter uses an optical sensor that directs light through the patient's finger and then measures the received light with a detector. This received light is translated into a saturation percentage and is displayed as an SpO₂ reading.

Indications

Pulse Oximetry is indicated for use in any patient who is at risk of developing hypoxemia.

Contraindications

None known.

ABOUT NIBP MONITORING

The LIFEPAK 12 NIBP monitor measures the blood pressure of the adult or pediatric patient. The monitor automatically inflates an occluding cuff and, using the oscillometric measurement technique, determines systolic, diastolic, mean arterial pressures, and pulse rate. The measurement can be initiated manually or set to recur at a predetermined interval.

Blood pressure measurements determined with this device are equivalent to those obtained by a trained observer using the cuff/stethoscope auscultation method, within the limits prescribed by the American National Standard, *Electronic or automated sphygmomanometers* (AAMI SP-10).

When a patient is experiencing arrhythmias during a measurement, the accuracy of the pulse determination may be affected or the time needed to complete a measurement may be extended. In shock conditions, the low amplitude of blood pressure waveforms makes it difficult for the monitor to accurately determine the systolic and diastolic pressures. The device automatically deflates if a blood pressure measurement cannot be obtained in 120 seconds.

Indications

Noninvasive blood pressure is indicated for detection in trends of hypertension or hypotension. These include patient conditions indicated by abnormalities in various physiologic parameters such as shock, evaluation of perfusion during dysrhythmias, major fluid shifts, evaluation of response to fluid therapy, and titration of vasoactive and cardiotoxic drugs. Noninvasive blood pressure monitoring may be useful during ECG monitoring or for post-defibrillation recovery analysis.

Contraindications

None known.

ABOUT END-TIDAL CO₂ (EtCO₂) MONITORING

The EtCO₂ monitor is a capnometric device that uses non-dispersive infrared spectroscopy to continuously measure the amount of CO₂ during each breath and report the amount present at the end of exhalation (EtCO₂). The sample is obtained by side stream method and can be used with intubated or nonintubated patients. Respiration rate is also measured and displayed in breaths per minute.

Indications

EtCO₂ monitoring is indicated for detection of trends in the level of expired CO₂. It is used for monitoring breathing efficacy and treatment effectiveness in acute cardiopulmonary care, for example, to determine if adequate compressions are being performed during CPR or to rapidly detect whether an endotracheal tube has been placed successfully. It is intended for use on adult and pediatric patients.

Contraindications

None known.

ABOUT INVASIVE PRESSURE (IP) MONITORING

Invasive monitoring is intended for use in patients that require continuous monitoring of physiological pressures in order to rapidly assess changes in patient condition and/or the patient's response to therapy. It may also be used to aid in medical diagnosis determination.

Indications

The LIFEPAK 12 invasive pressure monitor is indicated for use in measuring arterial, venous, intracranial and other physiological pressures using an invasive catheter system with a compatible transducer. It may be used on the adult or pediatric patient.

Contraindications

None known.

ABOUT VITAL SIGN AND ST MONITORING

The vital sign and ST monitoring features of the LIFEPAK 12 defibrillator/monitor provide documentation of patient's vital signs and ST segment measurements over 8 hours. All active vital sign parameters and ST measurements can be displayed graphically for up to 8 hours. ST segment measurement is initiated with a 12-lead ECG and is derived from the GE Medical systems 12SL™ ECG analysis program.

ABOUT ECG MONITORING

The ECG (electrocardiogram) is a recording of the electrical activity of the heart. ECG monitoring allows for identification and interpretation of cardiac rhythms or dysrhythmias and calculation of heart rate. The ECG is obtained by placing either electrodes or paddles on the patient and allows the heart's electrical activity to be monitored and recorded.

TEXT CONVENTIONS

Throughout these Operating Instructions, special text characters (for example, CAPITAL LETTERS such as ON/OFF and CONNECT ELECTRODES) are used to indicate labels, screen messages, and voice prompts.

SAFETY INFORMATION

This section provides important information to help you operate the LIFEPAK 12 defibrillator/monitor. Familiarize yourself with all of these terms, warnings, and symbols.

Terms	page 1-2
General Warnings and Cautions	1-2
Symbols	1-3

TERMS

The following terms are used either in these Operating Instructions or on the LIFEPAK 12 defibrillator/monitor:

Danger: Immediate hazards that will result in serious personal injury or death.

Warning: Hazards or unsafe practices that may result in serious personal injury or death.

Caution: Hazards or unsafe practices that may result in minor personal injury, product damage, or property damage.

GENERAL WARNINGS AND CAUTIONS

The following are general warning and caution statements. Other specific warnings and cautions are provided as needed in other sections of these Operating Instructions.

WARNINGS!

Shock hazard.

The defibrillator delivers up to 360 joules of electrical energy. Unless properly used as described in these Operating Instructions, this electrical energy may cause serious injury or death. Do not attempt to operate this device unless thoroughly familiar with these Operating Instructions and the function of all controls, indicators, connectors, and accessories.

Shock hazard.

Do not disassemble the defibrillator. It contains no operator serviceable components and dangerous high voltages may be present. Contact authorized service personnel for repair.

Shock or fire hazard.

Do not immerse any portion of this device in water or other fluids. Avoid spilling any fluids on device or accessories. Spilled liquids may cause the defibrillator and accessories to perform inaccurately or fail. Do not clean with ketones or other flammable agents. Do not autoclave or sterilize this device or accessories unless otherwise specified.

Possible fire or explosion.

Do not use this device in the presence of flammable gases or anesthetics. Use care when operating this device close to oxygen sources (such as bag-valve-mask devices or ventilator tubing). Turn off gas source or move source away from patient during defibrillation.

Possible electrical interference with device performance.

Equipment operating in close proximity may emit strong electromagnetic or radio frequency interference (RFI), which could affect the performance of this device. RFI may result in distorted ECG, incorrect ECG lead status, failure to detect a shockable rhythm, cessation of pacing, or incorrect vital sign measurements. Avoid operating the device near cauterizers, diathermy equipment, or other portable and mobile RF communications equipment. Do not rapidly key EMS radios on and off. Refer to Appendix H for recommended distances of equipment. Contact Physio-Control Technical Support if assistance is required.

Possible electrical interference.

This defibrillator may cause electromagnetic interference (EMI) especially during charge and energy transfers. EMI may affect the performance of equipment operating in close proximity. Verify the effects of defibrillator discharge on other equipment prior to using the defibrillator in an emergency situation, if possible.

Possible electrical interference.

Using cables, electrodes, or accessories not specified for use with this device may result in increased emissions or decreased resistance to electromagnetic interference which could affect the performance of this device or of equipment in close proximity. Use only parts and accessories specified in these Operating Instructions.

Possible device shutdown.

Always have immediate access to a spare, fully charged, properly maintained battery. Replace the battery or connect the defibrillator to AC power when the device displays a low battery warning.

Possible improper device performance.

Using other manufacturers' cables, electrodes, or batteries may cause the device to perform improperly and invalidates the safety agency certification. Use only the accessories specified in these Operating Instructions.

Possible improper device performance.

Changing factory default settings will change the behavior of the device. Changes to the default settings must only be made by authorized personnel.

Possible failure to detect an out of range condition.

Reselecting QUICK SET will reset the alarm limits around the patient's current vital sign values. This may be outside the safe range for the patient.

Safety risk and possible equipment damage.

Monitors, defibrillators, and their accessories (including electrodes and cables) contain ferromagnetic materials. As with all ferromagnetic equipment, these products must not be used in the presence of the high magnetic field created by a Magnetic Resonance Imaging (MRI) device. The high magnetic field created by an MRI device will attract the equipment with a force sufficient to cause death or serious personal injury to persons between the equipment and the MRI device. This magnetic attraction may also damage the equipment and affect the performance of the equipment. Skin burns will also occur due to heating of electrically conductive materials such as patient leads and pulse oximeter sensors. Consult the MRI manufacturer for more information.

CAUTION!

Possible device damage.

To help prevent component damage, do not mount device near vibration sources such as engine struts and landing gear.

Note: The LIFEPAK 12 defibrillator/monitor and its accessories that are intended for direct or casual contact with the patient are latex-free.

SYMBOLS

The symbols below may be found in these Operating Instructions or on various configurations of the LIFEPAK 12 defibrillator/monitor and accessories:



Defibrillation-proof type CF patient connection

















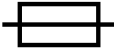



























Defibrillation protected, type BF patient connection













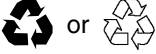







Attention, consult accompanying documents

Safety Information

	Warning, high voltage
	Type BF patient connection
	Static-sensitive device (SSD)
	Safety Class II equipment (reinforced insulation)
	Type B equipment
	Chassis ground
	Fuse
	Positive terminal
	Negative terminal
	Lot number (batch code)
	Use By date shown: yyyy-mm-dd or yyyy-mm
	Reorder number
	Date of manufacture
	Single use only
	Indoor use only
	Alarm on
	Alarm off
	VF/VT alarm on
	VF/VT alarm silenced
	Greater than
	Less than
	Joules
	Contrast

	Home screen button
	No battery in well (in software version -022 or earlier)
	FASTPAK® battery in well, fully charged (in software version -022 or earlier)
	FASTPAK battery in well, discharged (in software version -022 or earlier)
	FASTPAK or LIFEPAK SLA battery in well 1, in use
	FASTPAK or LIFEPAK SLA battery in well 2, not in use
	FASTPAK or LIFEPAK SLA battery in well, discharged
	LIFEPAK NiCd battery in well, fully charged, not in use
	LIFEPAK NiCd battery in well, discharged
	Heart rate/pulse rate indicator
	Shock count (x) on screen
	Mark of conformity according to the European Medical Device Directive 93/42/EEC
	Canadian Standards Association certification for Canada and the United States
	Recognized component mark for Canada and the United States
	DC voltage
	AC voltage
	On (power: connection to the AC mains)
	Off (power: disconnection from the AC mains)
	Power on/off
	[signal] Input

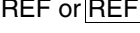
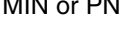
Safety Information

	[signal] Output
	Recycle this item
	Recycle NiCd battery
	See instructions for disposal procedure
	AC to DC adapter
	System connector/Data in
	LIFEPAK 12 to LIFEPAK 12 cable (See Send Configuration Setup Menu, page 9-18)
	Telephone line connector
	Switch on
	Switch off
	Pace arrow, noninvasive pacing
	Pace arrow, internal pacing
	R-wave sense marker
	Event marker
	CO2 exhaust
	Biphasic defibrillation shock
	Item is latex free
	For USA audiences only
	Reorder number
	Manufacturer's Item Number
	Catalog number used for placing orders
	By prescription only

BASIC ORIENTATION

This section provides a basic orientation to the LIFEPAK 12 defibrillator/monitor.

Introduction	page 2-2
Unpacking and Inspecting	2-3
Controls, Indicators, and Connectors	2-3
Entering Patient Data	2-20
Setting Alarms	2-22
Managing Alarms	2-23
Connecting to Power	2-25

INTRODUCTION

The LIFEPAK 12 defibrillator/monitor is a complete acute cardiac care response system used by authorized healthcare providers in and out of the hospital. It can be used for air and ground transport.

The LIFEPAK 12 defibrillator/monitor offers the following optional features:

- Biphasic defibrillation waveform
- Semi-automatic defibrillation
- Noninvasive pacemaker
- Pulse oximeter
- Interpretive 12-lead ECG
- Noninvasive blood pressure (NIBP) monitor
- End-tidal CO₂ (EtCO₂) monitor
- Invasive pressure (IP) monitor
- Vital sign (VS) and ST monitoring
- Fax transmission
- Paddle accessories
- Electroluminescent (EL) display (The optimal viewability of an EL display is compromised in direct sunlight.)

Note: These Operating Instructions include information and procedures related to *all* features of the LIFEPAK 12 defibrillator/monitor. Your LIFEPAK 12 defibrillator/monitor may not have all of these features. For more information, contact your Physio-Control representative or call the number listed on the back cover of these Operating Instructions.

This LIFEPAK 12 defibrillator/monitor is available with one of two defibrillation waveforms: monophasic or biphasic. For a description of each defibrillation waveform, refer to page A-6. The LIFEPAK 12 defibrillator control and display functions are the same for either defibrillation waveform; however, the LIFEPAK biphasic defibrillator provides more energy levels. If your emergency care system consists of a mix of biphasic and monophasic defibrillators, special consideration should be given to the energy protocols and staff training regarding energy protocols.

The LIFEPAK 12 defibrillator/monitor uses QUIK-COMBO® pacing/defibrillation/ECG electrodes or FAST-PATCH® disposable defibrillation/ECG electrodes for ECG monitoring and patient therapy. The therapy cable connects the QUIK-COMBO or FAST-PATCH electrodes to the defibrillator. For more information about QUIK-COMBO or FAST-PATCH electrodes, refer to Section 5 of these Operating Instructions.

Standard paddles (adult defibrillation paddles) are an option for the LIFEPAK 12 defibrillator/monitor. The standard paddles can be used for QUIK-LOOK® ECG monitoring, defibrillation, and synchronized cardioversion therapies. When using standard paddles, a conductive interface designed for defibrillation, such as defibrillation gel or gel pads, must be used between the paddle electrode surface and the skin.

Optional pediatric and internal paddle accessories are also available. The standard adult paddles can be used for any pediatric patient weighing greater than approximately 10 kg (22 lbs) as long as the paddles fit completely on the chest and there is at least one inch of space between the paddle electrodes. Pediatric paddles should be used for patients less than 10 kg (22 lbs) or those whose chests are too small to accommodate the standard paddles.

For more information about using paddle accessories, refer to Section 5 of these Operating Instructions.

UNPACKING AND INSPECTING

Once you have removed the LIFEPAK 12 defibrillator/monitor from the shipping container, examine the device and all accessories for any sign of damage. Make sure you have all the required supplies and accessories including cables, batteries, and ECG paper. Save the shipping container and foam inserts for possibly shipping the device at a later date.

CONTROLS, INDICATORS, AND CONNECTORS

The following figures provide a brief description of the controls, indicators, and connectors for the LIFEPAK 12 defibrillator/monitor. Figure 2-1 shows the front view of the LIFEPAK 12 defibrillator/monitor divided into six areas. Figure 2-2 through Figure 2-12 show details of each area. Figure 2-15 shows the back view of the defibrillator. Additional information about areas 3, 4, and 6 follow the applicable figures.

Note: The light-emitting diode (LED) in a function button is on when the corresponding function is active. For example, the *ADVISORY* button LED is on when the advisory function is active.

Front View

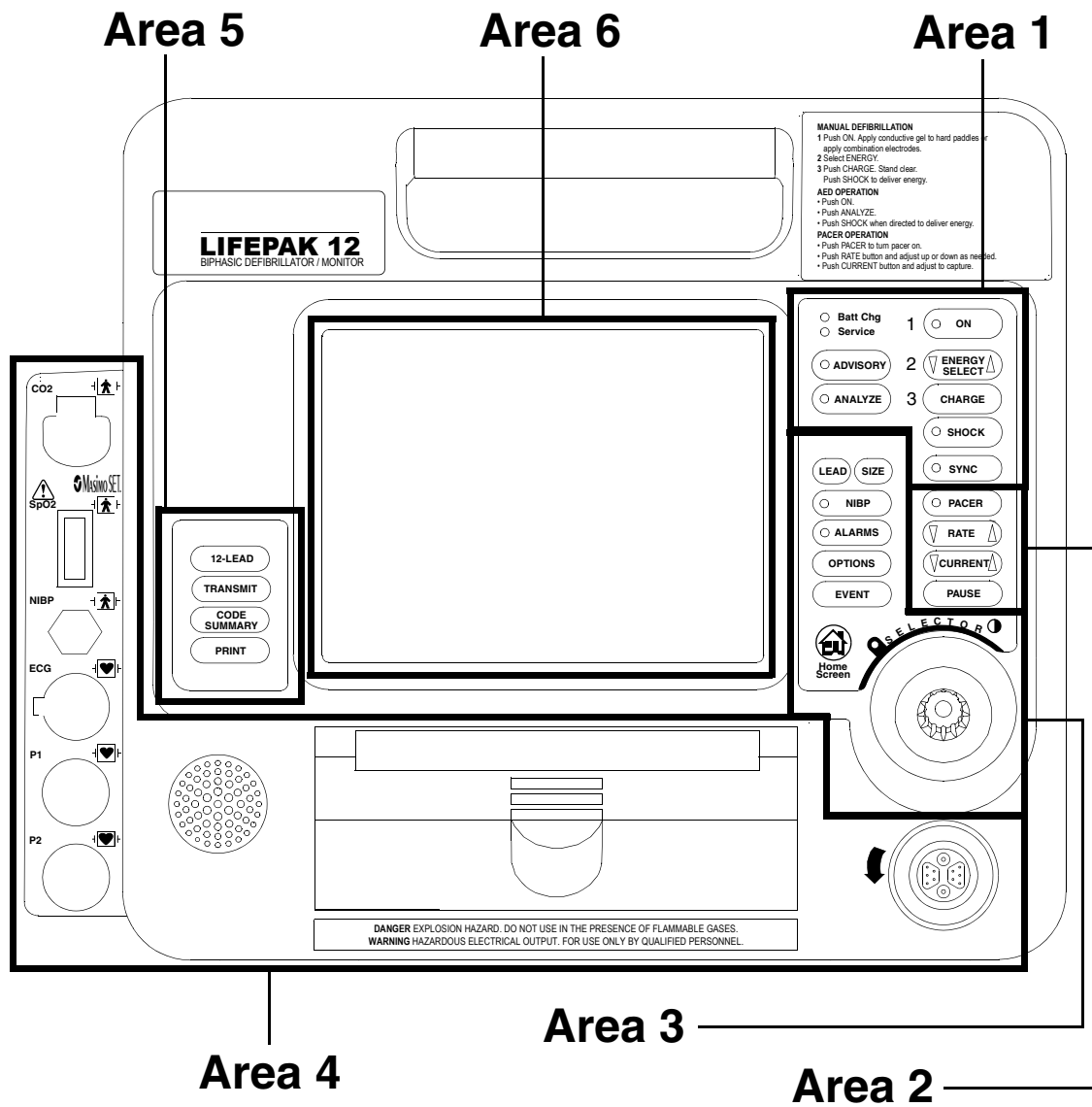
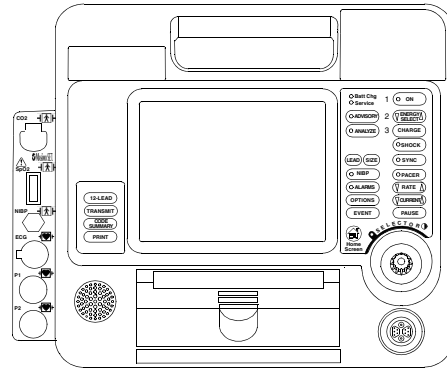

Figure 2-1 Front View

Area 1

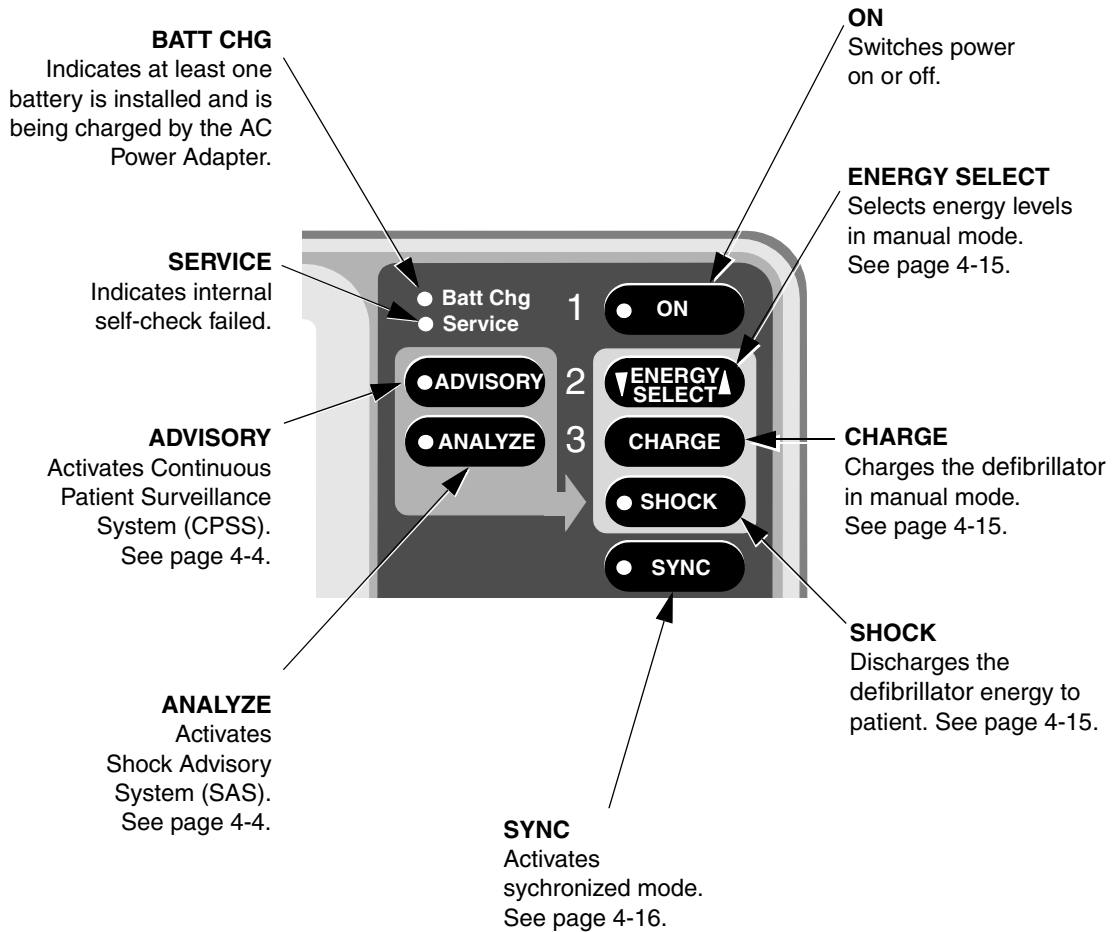
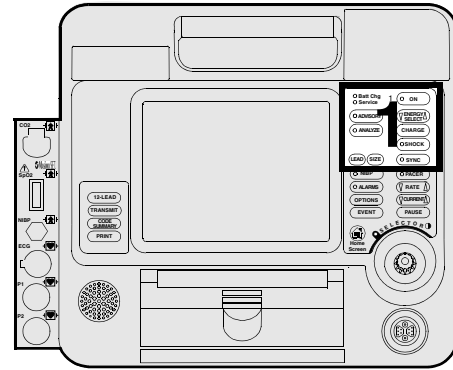

Figure 2-2 Defibrillation Controls

Area 2

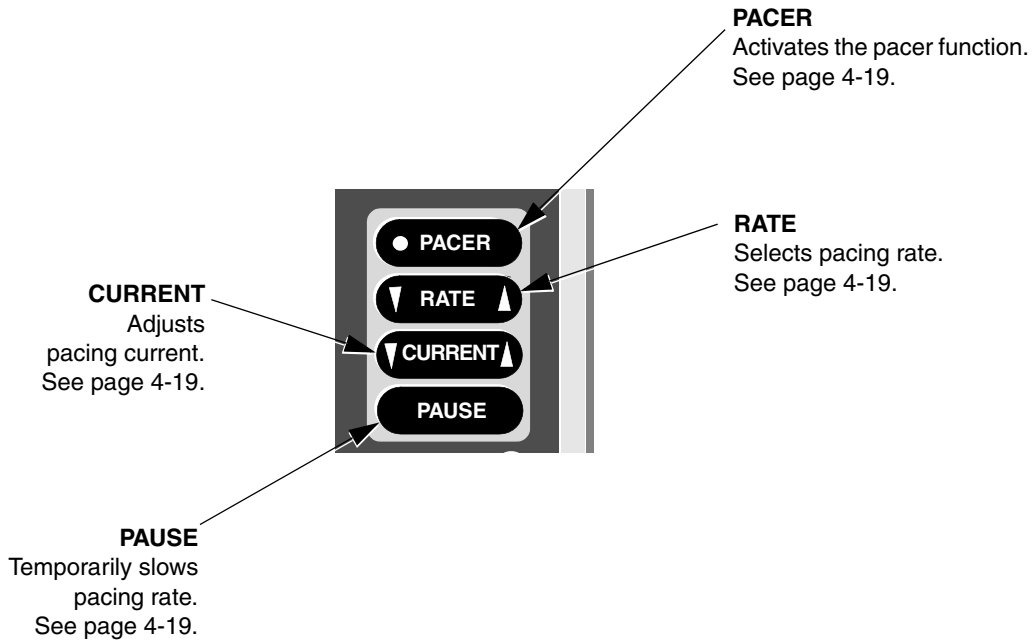
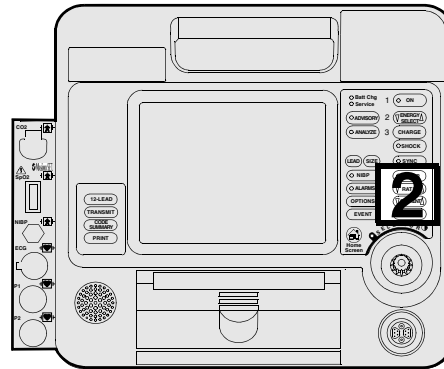

Figure 2-3 Pacing Controls

Area 3

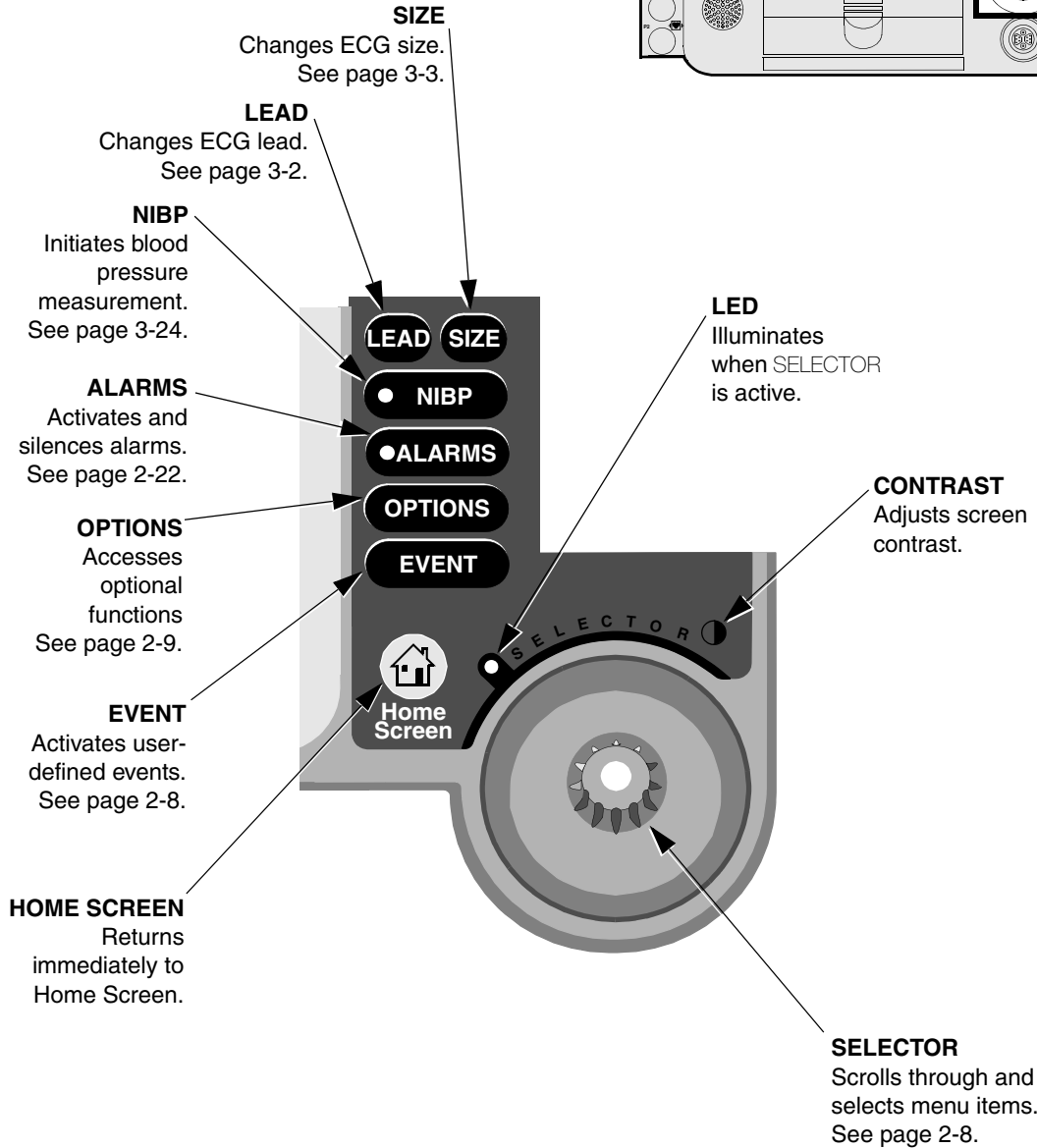
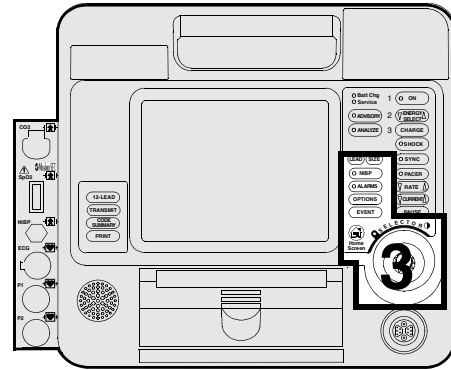

Figure 2-4 User Controls

Area 3

The following paragraphs provide additional information about the controls shown in Area 3, page 2-7.

Contrast

Press the **CONTRAST** button and rotate the **SELECTOR** to adjust the screen contrast. At power on, the contrast setting defaults to the previously adjusted setting. The **CONTRAST** button is disabled in LIFEPAK 12 defibrillator/monitors with the EL display.

Selector

The **SELECTOR** allows you to navigate through and select functions that display on the LIFEPAK 12 defibrillator/monitor screen. The **SELECTOR** is active when the indicator LED to the left is illuminated. When active, you can rotate the **SELECTOR** to highlight and select certain areas of the screen and displayed menu items. Pressing the **SELECTOR** activates the highlighted menu item. Default menu items are highlighted with a gray background; when a menu item is selected, the background is black.

Home Screen

The home screen is the background screen that displays during ECG monitoring. Pressing **HOME SCREEN** returns you to the home screen from any menu screen or overlay, except during AED analysis or manual defibrillation charging and shocking.

Event

Pressing **EVENT** displays the following overlay.

Events	
Generic	CPR
Adenosine	Dopamine
ASA	Epinephrine
Atropine	Intubation
Bicarb	More...

Use the **SELECTOR** to scroll through and select choices.

The selected event and time stamp appear in the message/status area on the screen. Events are printed in the **CODE SUMMARY** Event Log. See page 9-9 for information about configuring events.

Options

Pressing **OPTIONS** displays the overlay shown in Figure 2-5. Use the **SELECTOR** to scroll through and select the choices.

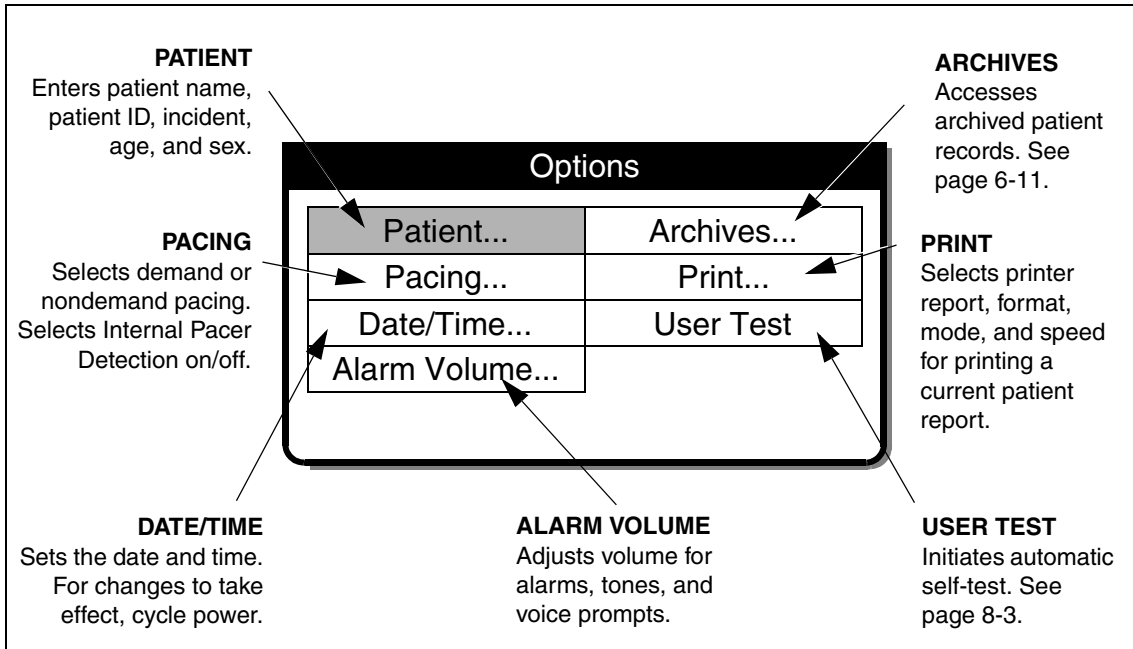

Figure 2-5 Options

Alarms

See page 2-22 for information about setting alarms.

Area 4

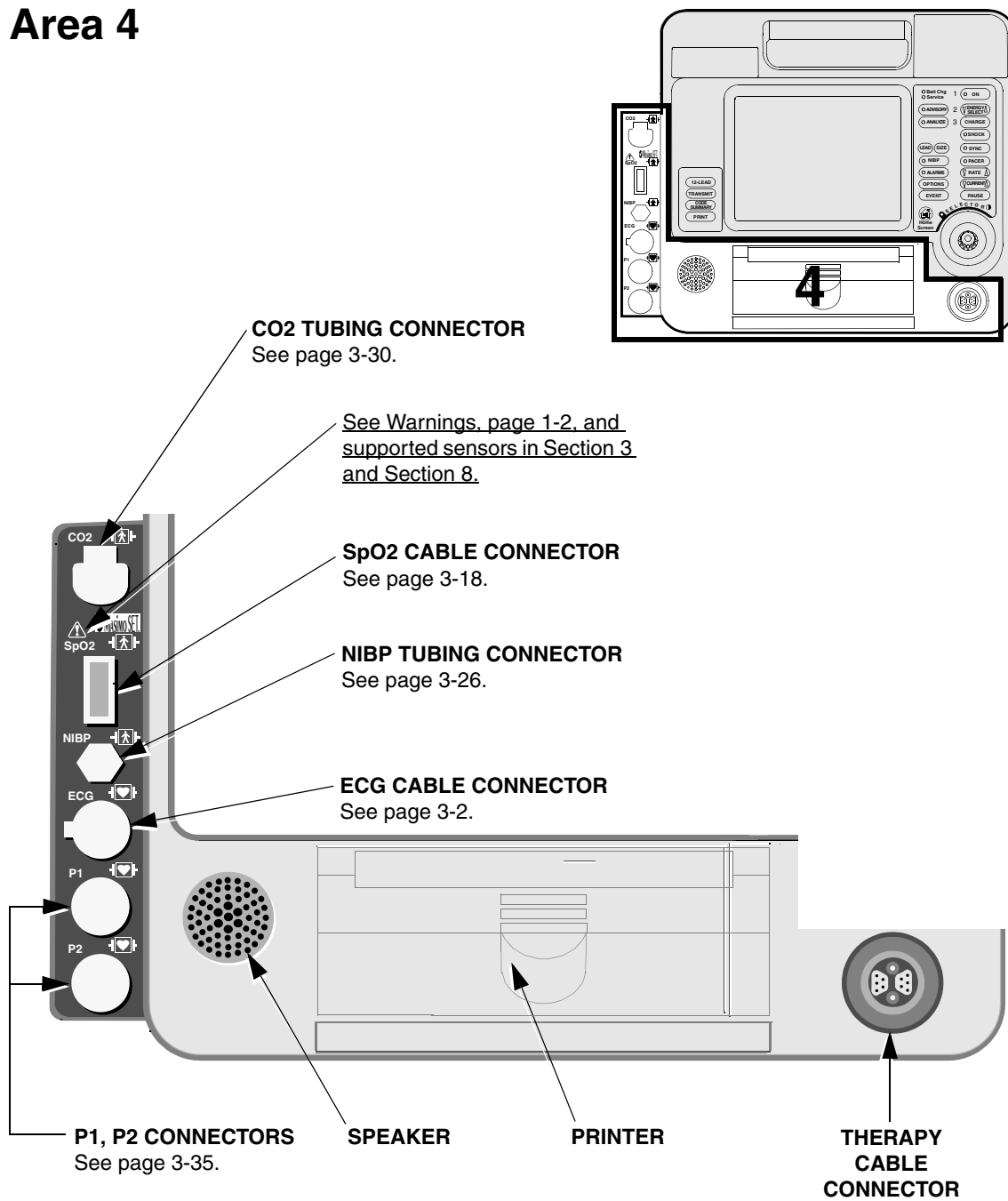

Figure 2-6 Cable Connectors, Speaker, and Printer

Area 4

The following paragraphs provide additional information about the therapy cable connector and printer shown in Area 4, page 2-10.

WARNING!

Possible equipment damage and inability to deliver therapy.

To protect the therapy cable connector from damage or contamination, keep therapy cable connected to the defibrillator at all times.

Connecting the Therapy Cable

To connect a therapy cable to the therapy cable connector:

- 1 Orient the therapy cable so that the arrow is on top with the cable angled to the right (see Figure 2-7).

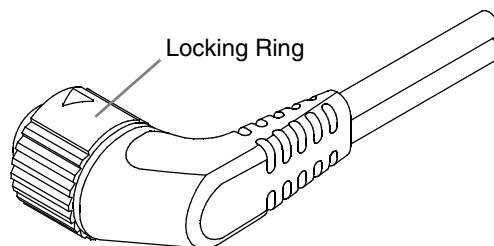

Figure 2-7 Therapy Cable Orientation

- 2 Insert the therapy cable into the therapy cable connector on the defibrillator.
- 3 Push the therapy cable until you feel the connector lock in place.

Disconnecting the Therapy Cable

To disconnect a therapy cable from the defibrillator:

- 1 Rotate the locking ring on the therapy cable in the direction of the arrow (counterclockwise) until it stops (see Figure 2-8).
- 2 Gently pull the cable out.

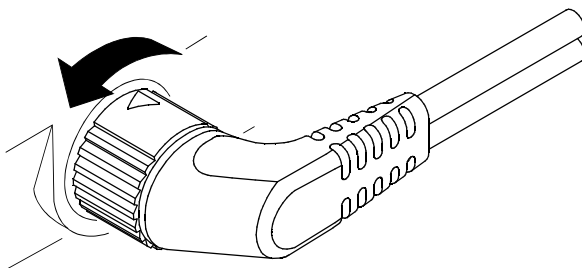

Figure 2-8 Disconnecting the Therapy Cable

CAUTION!**Possible printer malfunction.**

Using other manufacturers' printer paper may cause the printer to function improperly and/or damage the print head. Use only the printer paper specified in these Operating Instructions.

Loading 50 mm Paper (MIN 804700)

The printer is equipped with an out-of-paper sensor to protect the printhead. The sensor automatically turns off the printer if paper runs out or if the printer door is open.

To load the paper:

- 1 Pull the slotted edge of the front printer door to open the printer.
- 2 Remove empty paper roll.
- 3 Insert new paper roll, grid facing forward.
- 4 Pull out a short length of paper.
- 5 Push the rear printer door in and push down on the front printer door to close.

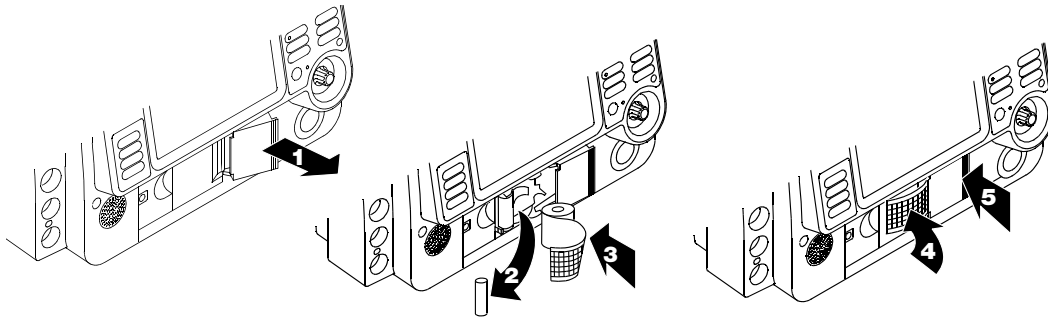

Figure 2-9 Loading 50 mm Paper

Loading 100 mm Paper (MIN 805319)

The printer is equipped with an out-of-paper sensor to protect the printer printhead. The sensor automatically turns off the printer if paper runs out or the printer door is open.

To load the paper:

- 1 Lift the printer door latch to release the door.
- 2 Pull out the printer door.
- 3 Remove the empty paper spool.
- 4 Insert a new paper roll with the graph side facing up. Make sure the end of the paper extends outward so it is exposed when the printer door is closed.
- 5 Close the printer door and push down on the latch until the door clicks shut.

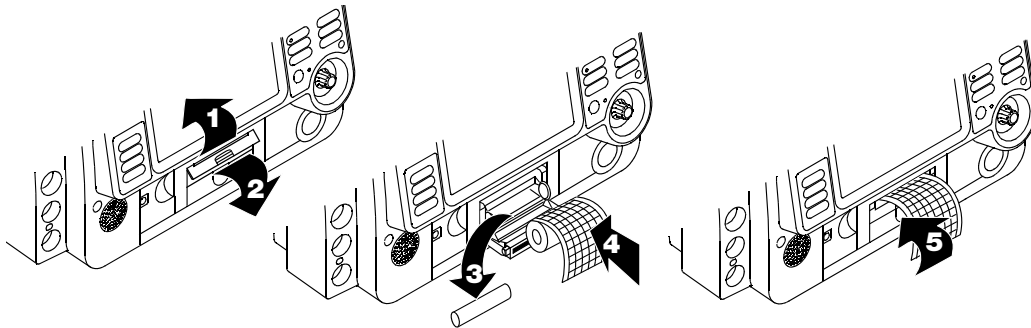
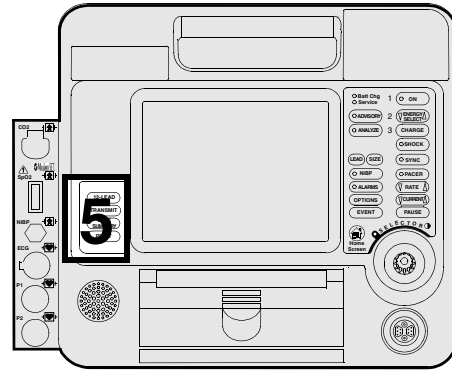

Figure 2-10 Loading 100 mm Paper

Area 5



12-LEAD
Initiates acquisition
of a 12-lead ECG.
See page 3-9.

TRANSMIT
Transmits current
patient data.
See page 6-7.

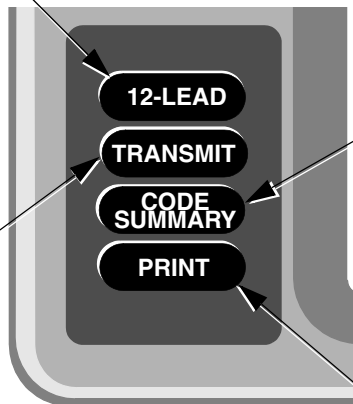

CODE SUMMARY
Prints a CODE
SUMMARY critical event
record.
See page 6-3.

PRINT
Starts or stops
the printer.

Figure 2-11 12-Lead ECG and Print Controls

Area 6

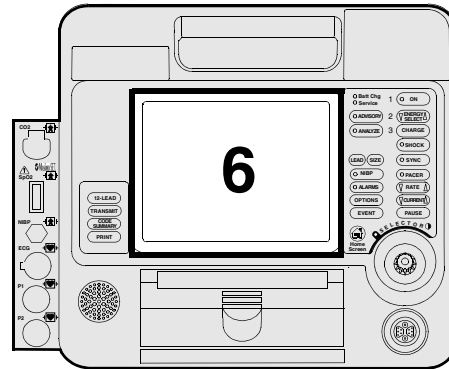

TOP SCREEN AREA

Displays ECG size, time, indicators for VF/VT alarm, battery charge, and selected energy.

MONITORING AREA
Displays patient monitoring parameters and alarm indicators. See page 2-15.

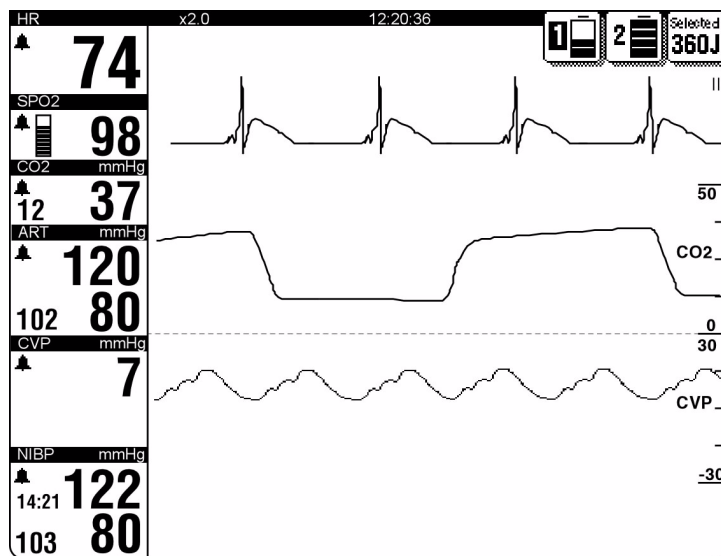

WAVEFORM CHANNEL AREA
Displays up to three waveform channels. See page 2-16.

STATUS MESSAGE AREA

Displays messages and alarms.

Figure 2-12 Screen

Area 6

The following paragraphs provide additional information about Area 6, page 2-14.

Monitoring Area — Heart Rate

The LIFEPAK 12 defibrillator/monitor displays a heart rate between 20 and 300 bpm. A heart rate symbol flashes with each beat. If the heart rate is below 20 bpm or pacing is active, the screen displays dashes (— —). Heart rates above 300 bpm do not yield valid systole tones and the displayed heart rate will not be valid. The displayed heart rate will be approximately one-half the actual rate.

The heart rate indicator is a tool to be used in addition to patient assessment. Care should be taken to assess the patient at all times and not rely solely on the heart rate displayed.

WARNINGS!

Failure to accurately count heart rate.

Heart rates above 300 bpm are not counted accurately and do not yield a valid systole tone and displayed heart rate. The displayed heart rate will be approximately one-half the actual rate. Do not rely solely on the displayed heart rate for patient assessment. Use a printout of the ECG to calculate actual heart rate.

Failure to detect a change in ECG rhythm.

Heart rate meters may continue to count the internal pacing pulses during occurrences of cardiac arrest or some arrhythmias. Do not rely entirely on heart rate meter alarms. Keep pacemaker patients under close surveillance.

QRS detection is essential for using the digital heart rate display, systole tone, synchronized cardioversion, and noninvasive demand pacing.

The QRS detector in the LIFEPAK 12 defibrillator/monitor selectively detects QRS complexes. It discriminates against most noise, muscle artifact, T-waves, and other spurious signals.

Detection of QRS complexes and rejection of other signals require the proper setting of ECG size. If ECG size is set too low, QRS complexes will not be detected, no systole tones or sense (synchronizer) markers will appear, and the heart rate display will be incorrect. If ECG size is set too high, systole tones and sense markers may occur on spurious signals and the heart rate display may be incorrect.

Monitoring Area — Pulse Rate. If the ECG is not active, either the SpO₂ or NIBP monitor can display pulse rate. The pulse rate source is indicated by PR (SPO₂) or PR (NIBP).

Monitoring Area — SpO₂ (pulse oximeter). The oxygen saturation level displays as a percentage from 50 to 100. Saturation below 50% displays as <50%. A fluctuating bar graph represents the pulse signal strength.

Monitoring Area — EtCO₂. The end-tidal CO₂ level displays in the units configured in setup: mmHg, kPa, or Vol%. Respiration rate displays in breaths per minute.

Monitoring Area — IP. The invasive pressure monitor displays systolic, diastolic, and mean pressure in mmHg or kPa. Two channels are available with default labels P1 and P2, and user-selectable labels ART (arterial pressure), PA (pulmonary artery pressure), CVP (central venous pressure), ICP (intracranial pressure), and LAP (left atrial pressure).

Monitoring Area — NIBP. The blood pressure monitor displays systolic, diastolic, and mean arterial pressure (MAP) in mmHg or kPa.

Waveform Channel Area

Channel 1. This is the top channel. It displays the primary ECG waveform. It is always visible.

Channel 2. This is the middle channel. It can display an additional waveform or a continuation of the Channel 1 ECG.

Channel 3. This is the bottom channel. It is active only when a 100 mm printer is installed in the LIFEPAK 12 defibrillator/monitor. It can display an additional waveform.

Selecting Waveform Channels

The defibrillator power must be on.

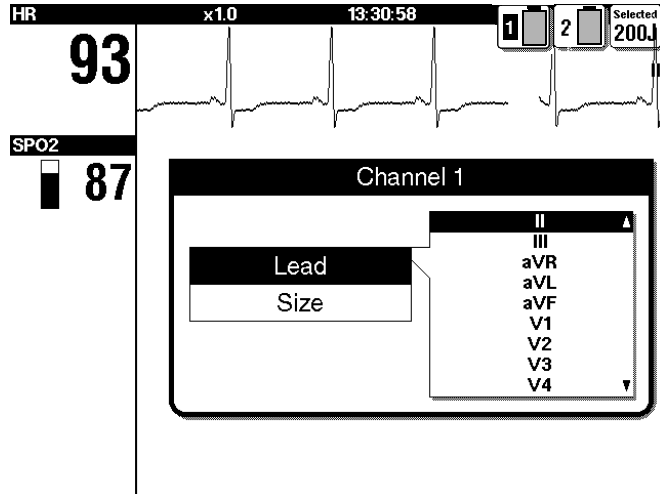

- 1 At the home screen, rotate the SELECTOR to highlight Channel 1, 2, or 3.
- 2 Press the SELECTOR. An overlay appears with the monitoring choices for the selected channel.
- 3 Rotate and press the SELECTOR to select monitoring choices for that channel.

Top Screen Area — Battery Symbols

When FASTPAK, FASTPAK 2, or LIFEPAK SLA batteries are installed in the LIFEPAK 12 defibrillator/monitor, symbol(s) appear in the top right of the screen area. These symbols represent the presence of batteries in the wells and not the various states of battery charge, except a discharge state. The battery number that is powering the defibrillator is highlighted black (see Figure 2-13). When the defibrillator is powered on with two batteries installed, battery 1 will always be discharged to the point of a low charge state before the defibrillator switches to battery 2. A discharged battery condition is indicated by an arrow (see Figure 2-13). The battery charge level is black and the symbol flashes until the battery is replaced.



Batteries in wells 1 and 2; battery in well 1 in use



Batteries in wells 1 and 2; battery in well 1 discharged

Figure 2-13 Symbols for FASTPAK and LIFEPAK SLA Batteries

When LIFEPAK NiCd batteries are installed in the LIFEPAK 12 defibrillator/monitor, symbol(s) appear in the top right of the screen area. These symbols represent the presence of batteries as well as various states of charge. The battery number that is powering the defibrillator is highlighted black (see Figure 2-14). When the defibrillator is powered on with two batteries installed, battery 1 will always be discharged to the point of a low charge state before the defibrillator switches to battery 2. A discharged battery condition is indicated by an arrow (see Figure 2-14). The battery charge level is black, and the symbol flashes until the battery is replaced.



Batteries in wells 1 and 2;
battery in well 1 discharged, battery
in well 2 is fully charged, not in use

Figure 2-14 Symbols for LIFEPAK NiCd battery

Note: If the LIFEPAK NiCd battery is not conditioned by the Battery Support System 2, the battery symbol will not display the levels of charge (see Figure 2-13).

Back View

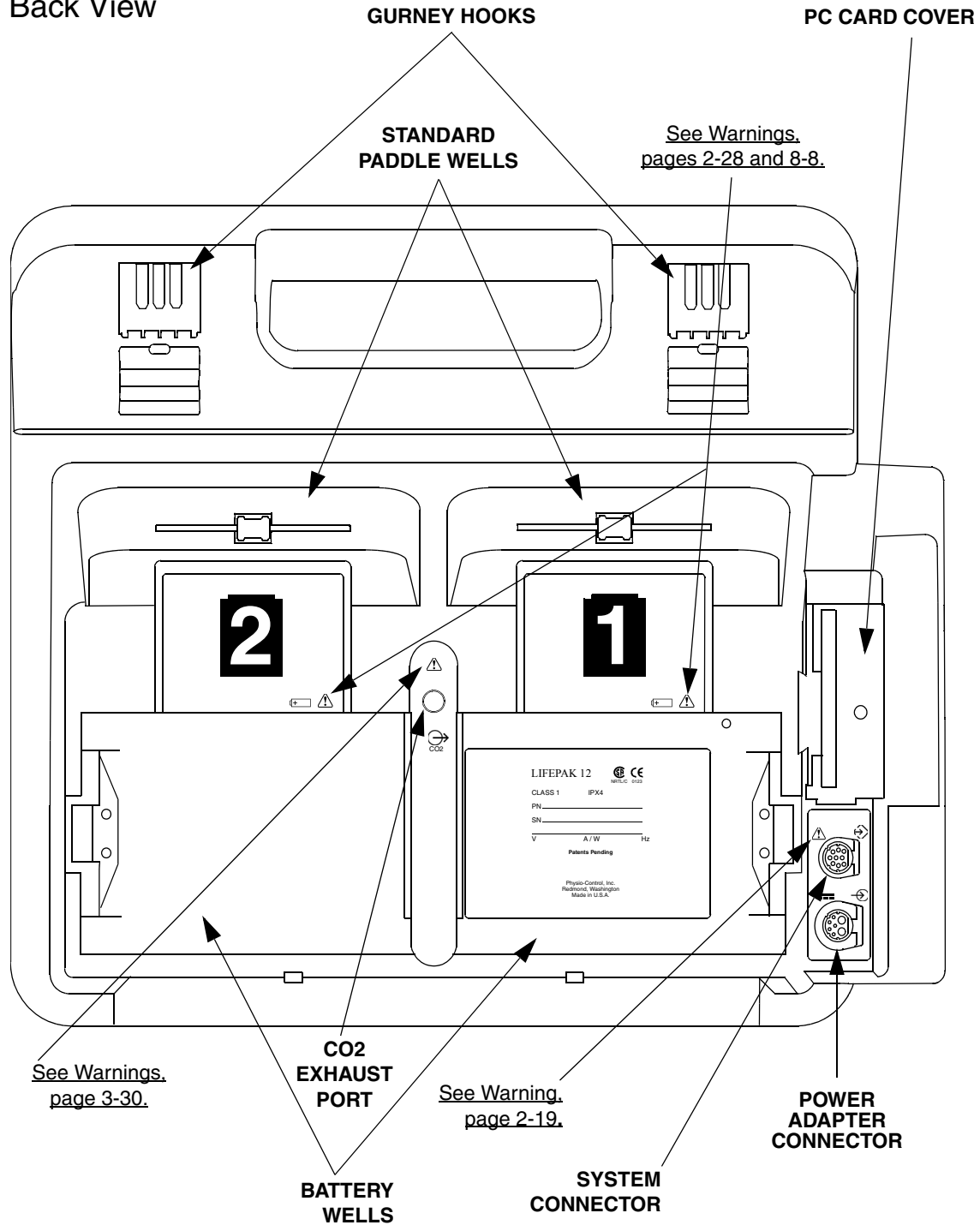

Figure 2-15 Back View

Back View

The following paragraphs provide additional information about the Back View, page 2-18.

System Connector

The system connector allows you to connect the LIFEPAK 12 defibrillator/monitor to an external modem or computer for telecommunication of patient reports. The system connector also allows access to another LIFEPAK 12 defibrillator/monitor, so that you can transfer setup information between devices, and it provides a real-time ECG output.

Note: To prevent unnecessary battery depletion, disconnect external devices from the system connector that require more than 100 mA when not in use.

WARNING!

Shock hazard.

If you are monitoring a patient and using the system connector, all equipment connected to the system connector must be battery powered or electrically isolated from AC power according to EN 60601-1. If in doubt, disconnect the patient from the defibrillator before using the system connector. For more information, contact Physio-Control Technical Support.

Power Adapter Connector

The power adapter connector allows you to connect the Physio-Control AC Power Adapter only to the LIFEPAK 12 defibrillator/monitor.

The power adapter may not be available for use in all countries. For more information, contact your local Physio-Control representative.

CO2 Exhaust Port

The CO2 exhaust port is connected to a scavenger system when using the EtCO2 in the presence of flammable gases such as nitrous oxide or certain other anesthetics.

Standard Paddles (Optional)

Figure 2-16 describes the standard paddles features.

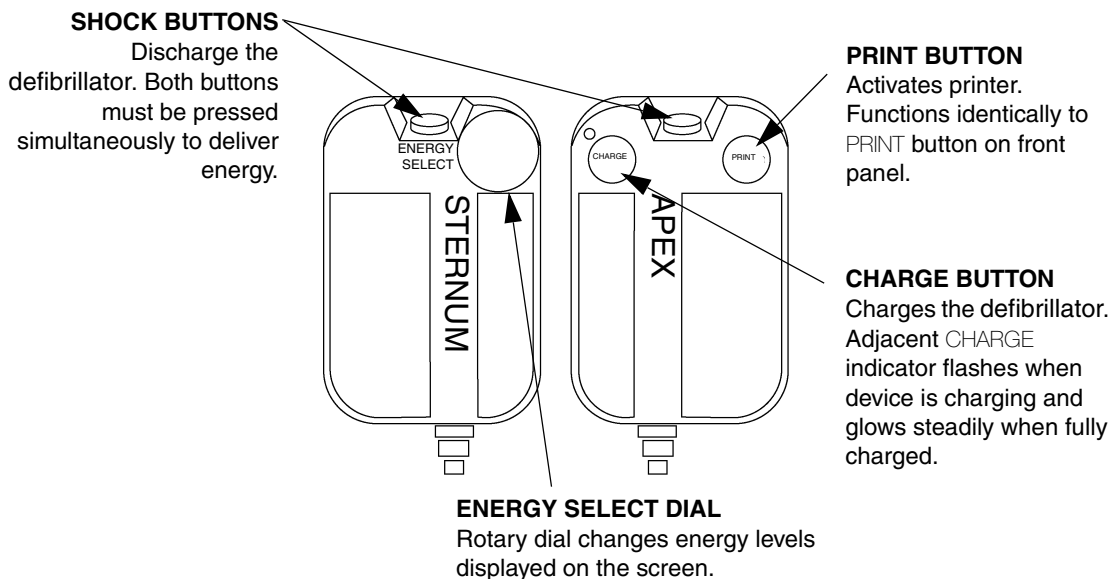

Figure 2-16 Standard Paddles

ENTERING PATIENT DATA

The following paragraphs describe how to enter or edit a patient’s name, incident, patient ID, age, or sex.

Options	
Patient...	Archives...
Pacing...	Print...
Date/Time...	User Test...
Alarm Volume...	

- 1 Press **OPTIONS**.
- 2 Select **PATIENT**.

To enter or edit a patient’s name, incident, or patient ID:

Options / Patient	
Last Name	MORTIMER
First Name	JOHN
Patient ID	528760004
Incident	BF301
Next Page...	

- 1 Select **LAST NAME**, **FIRST NAME**, **INCIDENT** or **PATIENT ID** fields. **LAST NAME** will be used as an example.

Options / Patient / Last Name		
MORTIMER█		
ABCDEFGHIJKLMNOPQRSTUVWXYZ		
End		End
Space		Space
Backspace		Clear
1 2 3 4 5 6 7 8 9 0 . , ; / ? - ! @ # \$ % ^ & * () < > { }		

- 2 Rotate the **SELECTOR** to scroll through the alphabet to display the desired letter or number.
- 3 Press the **SELECTOR**.
- 4 The character will appear in the highlighted area. Repeat Step 2 and Step 3 until the name is complete.
- 5 Scroll and select **END** when the name is complete.

There are three additional commands: **BACKSPACE** – moves highlight bar left one space
CLEAR – clears all characters in the name field
SPACE – inserts a blank space

To enter or edit a patient's age:

The screenshot shows a menu titled "Options / Patient". On the left side, there are three menu items: "Age", "Sex", and "Previous Page...". The "Age" item is highlighted with a black background. To the right of the menu items are two input fields. The top field contains the number "40" and the bottom field contains the word "Male".

- 1 Select AGE.
- 2 Rotate the SELECTOR to scroll to the desired age.
- 3 Press the SELECTOR.

To enter or edit a patient's sex:

The screenshot shows the same "Options / Patient" menu. In this view, the "Sex" item is highlighted with a black background. The input fields to the right still show "40" and "Male".

- 1 Select SEX.
- 2 Rotate the SELECTOR to highlight MALE or FEMALE.
- 3 Press the SELECTOR.

SETTING ALARMS

Alarms for the LIFEPAK 12 defibrillator/monitor can be configured to be on or off when the defibrillator is powered up. When the alarms are configured ON, predetermined limits are set. To view these limits, press the ALARMS button. The limits will temporarily appear to the right of the parameter value. To change the limits, select QUICK SET.

When the alarms are configured OFF, the ALARMS button must be pressed and QUICK SET selected to enable alarms.

When you press the ALARMS button, the following ALARMS overlay appears:

Alarms	
Quick Set	
Limits	Wide
Silence	2 min
VF/VT Alarm	Off

Select QUICK SET to activate the alarms for all active parameters. The QUICK SET limits are automatically set based on the patient's current vital sign values (refer to Table 2-1). The alarm limits default to the displayed setting (WIDE or NARROW).

Alarms	
Quick Set	
Limits	Wide
Silence	2 min
VF/VT Alarm	Off



Select LIMITS to change the alarm limits to WIDE or NARROW (refer to Table 2-1).

Alarms	
Quick Set	
Limits	Wide
Silence	2 min
VF/VT Alarm	Off

Select SILENCE to turn off the audible alarm for up to 15 minutes. If an alarm limit is exceeded while the alarm is silenced, the violated parameter flashes, an alarm message appears, but the alarm tone remains silent.

Alarms	
Quick Set	
Limits	Wide
Silence	2 min
VF/VT Alarm	Off

- 1 Select VF/VT ALARM to turn on continuous monitoring for ventricular fibrillation and ventricular tachycardia in manual mode.

A symbol appears above the primary ECG when the alarm is on  or when the alarm is silenced or suspended .

- 2 Reselect VF/VT to turn off this alarm.

Note: When the VF/VT ALARM is on, you are limited to PADDLES LEAD or LEAD II.

See "Selecting ECG Lead and Size" on page 3-2.

Note: The VF/VT alarm will be suspended when the noninvasive pacemaker is on. The alarm is also suspended when the device is charging or is charged.

Note: The VF/VT alarm has been validated only on adult ECGs.

Table 2-1 Alarm Limits for Wide and Narrow

Parameter	Range	Wide Limits*		Narrow Limits*		Limits Range**	
		Low	High	Low	High	Low	High
Heart Rate (bpm)	<60	-20	+35	-10	+25	30-150	100-250
	60-79	-25	+40	-20	+30		
	80-104	-30	+40	-30	+30		
	≥105	-35	+45	-25	+25		
SpO2 (%)	≥90	-5	+3	-5	+3	50	90-100
	<90	-5	+3	-5	+3		
Systolic BP, P1, P2 (mmHg)	<90	-20	+35	-10	+25	30	245
	90-114	-20	+35	-10	+25		
	115-140	-25	+35	-10	+20		
	>140	-25	+35	-10	+20		
Diastolic BP, P1, P2 (mmHg)	<65	-15	+25	-10	+25	12	210
	65-90	-15	+15	-15	+10		
	>90	-15	+15	-15	+10		
EtCO2 (mmHg/%)	—	-10/-1.3	+15/+2.0	-10/-1.3	+15/+2.0	5/0.7	70/9.2
Inspired CO2 (mmHg/%)	—	n/a	+5/+0.7	n/a	+3/+0.4	n/a	0/0-10/1.3
Respiration Rate (RR)	<15	-8	+8	-4	+4	5-15	10-60
	≥15	-15	+15	-8	+8		

Table 2-1 Alarm Limits for Wide and Narrow (Continued)

Parameter	Range	Wide Limits*		Narrow Limits*		Limits Range**	
		Low	High	Low	High	Low	High
Systolic PA (mmHg)	<15	-6	+12	-4	+6	10	100
	15–35	-8	+16	-6	+8		
	>35	-12	+16	-8	+10		
Diastolic PA (mmHg)	<5	-4	+12	-4	+8	0	50
	5–13	-4	+16	-6	+6		
	>13	-6	+16	-6	+6		
CVP (mmHg)	>0	-10	+10	-5	+5	0	25
ICP, LAP (mmHg)	<15	-6	+6	-4	+4	0	40
	≥15	-6	+8	-4	+6		

*Numbers are ± from patients' initial value.

**Numbers are absolute range values.

MANAGING ALARMS

The alarm bell symbol indicates when alarms are on  or off . When alarms are on and an alarm limit is exceeded, a tone sounds, the violated parameter flashes, and an alarm message appears.

To manage an alarm:

- 1 Press **ALARMS**. This silences the alarm for 2 minutes.
- 2 Assess the cause of the alarm.
- 3 Assess the appropriateness of the limits settings (**WIDE** or **NARROW**).
- 4 If the patient is unstable, consider silencing the alarm for up to 15 minutes while attending to the patient. Do **not** reselect **QUICK SET**.

WARNING!

Possible failure to detect an out of range condition.

Reselecting **QUICK SET** will reset the alarm limits around the patient's current vital sign values. This may be outside the safe range for the patient.

- 5 Once the patient is stable, reselect **QUICK SET** if necessary.

When alarms are on, you can silence them preemptively for up to 15 minutes.

To silence alarms preemptively:

- 1 Press **ALARMS**.
- 2 Select **SILENCE**.
- 3 Select **SILENCE** duration of 2, 5, 10, or 15 minutes.
- 4 The message **ALARMS SILENCED** appears on the bottom of the display screen.

CONNECTING TO POWER

The LIFEPAK 12 defibrillator/monitor operates using external removable batteries. Depending on your usage requirements, the batteries can be nickel-cadmium (NiCd) or sealed lead acid (SLA). NiCd batteries are best suited for high-use transport environments where the batteries are cycled frequently. SLA batteries are best suited for low use transport, or crash cart environments where the batteries are continuously charged. For further information, refer to Section 8, "Maintaining the Equipment."

The defibrillator/monitor can also operate using the Physio-Control AC Power Adapter. For further information regarding the power adapter, refer to Section 7, "Power Adapter."

Batteries

Table 2-2 describes the different batteries available.

Table 2-2 Biphasic LIFEPAK 12 Defibrillator/Monitor Batteries

Name	Type	Amp Hours	Fuel Gauge	Charger
FASTPAK	NiCd	1.2	no	Battery Support System or Battery Support System 2
FASTPAK 2	NiCd	1.2	yes	Battery Support System 2
LIFEPAK NiCd	NiCd	1.7 & 2.4	yes	Battery Support System 2
LIFEPAK SLA	SLA	2.5	no	Battery Support System 2

Battery Type: Nickel-Cadmium (NiCd) or Sealed Lead-Acid (SLA).

Amp Hours: The amount of capacity the battery has when new and fully charged.

Fuel Gauge: Tracks capacity to show how much charge and/or capacity is left in the battery.

Charger: Identifies which Battery Support System to use for charging, conditioning, and shelf life testing. For more information, refer to the applicable Battery Support System Operating Instructions.

Understanding Batteries and Battery Support Systems

The following paragraphs describe battery selection and availability and battery support systems.

Choosing the Right Type of Battery for Optimum Battery Life

Physio-Control is committed to helping maintain the readiness of its customers' defibrillator/monitors. Using the correct battery type for each application is critical for optimum battery life. Important choice factors include:

- Frequency of use
- Length of time between uses
- Length of time needed for each use (for instance, transport)
- Maintenance procedures
- Whether the defibrillator/monitor will be used primarily on AC power or on battery power

Frequency of use: If the battery is expected to be charged and discharged frequently, the Nickel-Cadmium (NiCd) battery technology is generally the preferred choice. NiCd batteries perform best when used with deep discharges in high-use environments.

Length of time between uses: If the length of time between uses is long, and the battery is on charge between uses, the Sealed Lead-Acid (SLA) battery is generally the better choice. A fully-charged SLA battery will hold its charge longer than a NiCd battery. However, SLA batteries may be damaged by storage in a discharged or partially-discharged state, and must be kept fully charged, with prompt recharging after discharge.

Length of time needed for each use: If the battery is expected to be used to full discharge, battery choice may then depend on the frequency of use. If the full discharge is done frequently, the NiCd battery is usually preferred. However, if full discharge of the battery is only done occasionally, with the battery on charge in the interim, the SLA battery is likely the better choice.

Maintenance procedures: For long service life, SLA batteries must be kept fully charged, and promptly recharged after discharge. NiCd batteries must be maintained with a process called “conditioning” that performs a special discharge process, then recharges, and measures battery performance. Both battery types should be tested periodically for shelf life (the amount of self-discharge the battery exhibits).

Use of AC power: If the defibrillator/monitor is to be used on AC power the majority of the time and the battery is primarily for power backup, based on current battery technology, an SLA battery would generally be preferred.

In general, the most significant factor for battery life is the selection and quality of the battery cells. Physio-Control uses high-quality battery cells. In some cases these are special cells, designed specifically for use in defibrillators.

Improving the Readiness of Defibrillators and Vital Signs Monitors

Physio-Control and its new family of “smart” batteries and chargers offer the user a greater choice of battery type and charging methods for specific applications. The heart of the system is the “smart” battery. It includes a microprocessor that measures a number of battery parameters to create a dynamic battery profile. This information is communicated continuously to the Battery Support System 2 and the LIFEPAK 12 defibrillator/monitor (when using the LIFEPAK NiCd battery only) and results in easy-to-understand battery status, optimized battery capacity, and improved battery life. Our newest products include:

FASTPAK 2 Battery: A NiCd battery designed for use in all Physio-Control defibrillator/monitors that use the FASTPAK battery, the FASTPAK 2 provides a state-of-charge indicator or “fuel gauge” at the push of a button. The “fuel gauge” is the output of a microprocessor that measures battery charge changes, including computation of battery self-discharge. The FASTPAK 2 battery also counts battery charge/discharge cycles and time. Based on these variables, the battery can actually “request” to be conditioned. All of this occurs automatically, without user intervention.

The FASTPAK 2 battery is a 1.2 ampere-hour battery that can be charged with the AC Power Adapter in the LIFEPAK 12 defibrillator/monitor. Because the Battery Support System 2 communicates with the FASTPAK 2 computer to maintain the battery’s “fuel gauge,” the FASTPAK 2 battery must be maintained in the Battery Support System 2.

NiCd batteries are usually preferred in high-use environments where the batteries are cycled frequently or deeply discharged each time.

LIFEPAK NiCd Battery: An NiCd battery designed for use in the LIFEPAK 12 defibrillator/monitor provides a state-of-charge indicator or “fuel gauge” at the push of a button. The “fuel gauge” is the output of a microprocessor that measures battery charge changes, including computation of battery self-discharge. The LIFEPAK NiCd battery also counts battery charge/discharge cycles and time. Based on these variables, the battery can actually ‘request’ to be conditioned. All of this occurs automatically, without user intervention. The LIFEPAK NiCd battery communicates state-of-charge information to the LIFEPAK 12 defibrillator/monitor (refer to Figure 2-14, page 2-17).

The LIFEPAK NiCd battery is a battery that can be charged with the AC Power Adapter in the LIFEPAK 12 defibrillator/monitor. Because the Battery Support System 2 communicates with the LIFEPAK NiCd computer to maintain the battery’s “fuel gauge,” the LIFEPAK NiCd battery must be maintained in the Battery Support System 2.

NiCd batteries are usually preferred in high-use environments where the batteries are cycled frequently or deeply discharged each time.

LIFEPAK SLA Battery: This Sealed Lead Acid battery is designed for use in the LIFEPAK 12 defibrillator/monitor and in future products. As a “smart” battery, it communicates what type of battery it is, its temperature, its number of cycles, time for conditioning, etc., to the AC Power Adapter and the Battery Support System 2. A 2.5 ampere-hour battery, the LIFEPAK SLA battery can be charged with the AC Power Adapter in the LIFEPAK 12 defibrillator/monitor, and can be optionally maintained in the Battery Support System 2. (The Battery Support System 2 provides a special SLA conditioning cycle that will measure performance to help ensure the LIFEPAK SLA battery is functioning properly.)

Use the LIFEPAK SLA battery for low-use or crash cart applications where batteries experience infrequent and shallow discharges. In these applications, the SLA batteries are continually charged by AC power. The AC Power Adapter and the Battery Support System 2 have been optimized to provide the maximum cycle life with SLA batteries.

Battery Support System 2: The Battery Support System 2 marks a major step forward in battery charging and maintenance. It is a sophisticated battery charger, using the proprietary pulse-charging technique of CADEX® Electronics Inc. Pulse charging helps to provide extended battery life, improved life in continuous trickle charging, and reduces capacity loss or “memory” effect in NiCd batteries. The Battery Support System 2 also provides automated battery conditioning and shelf-life testing. It communicates with the smart batteries (the FASTPAK 2, LIFEPAK NiCd, and the LIFEPAK SLA batteries) to determine the battery type, charging parameters, and whether conditioning is required. This frees the user from the task of manually logging when battery maintenance was last performed; the smart battery knows when maintenance was last done and knows when to ask for it next. The Battery Support System 2 is also capable of charging and maintaining FASTPAK batteries (although maintenance is selected manually). Battery maintenance (charging, conditioning and shelf-life testing) is performed in all three wells. While battery conditioning is not required with SLA batteries, conditioning can be performed on them, providing a comprehensive test of battery performance. Finally, the Battery Support System 2 provides a forward-compatible platform that will function with new Physio-Control batteries as they become available.

AC Power Adapter for Greater System Flexibility: The AC Power Adapter is designed for use with the LIFEPAK 12 defibrillator/monitor and incorporates the same proprietary pulse-charging technique as the Battery Support System 2. The Adapter provides line power for the direct operation of all LIFEPAK 12 defibrillator/monitor functions, and simultaneously provides charging for any installed batteries. Even if the batteries in the LIFEPAK 12 defibrillator/monitor are completely discharged or removed, the AC Power Adapter provides monitoring and therapy operation.

The Adapter communicates with the LIFEPAK batteries and the LIFEPAK 12 defibrillator/monitor, and can determine each battery's state of charge. (If batteries require charging, the battery with the greatest charge is charged first, followed by the next battery.) Battery types can be intermixed, if desired, and they are properly charged in sequence.

CAUTION!

Inability to Charge Battery.

The AC Power Adapter can not charge the LIFEPAK NiCd 2.4 amp hour battery (PN 3009376-001) unless the power adapter is labeled “LIFEPAK NiCd 2.4 AH compatible”.

The AC Power Adapter does not provide battery conditioning. Applications that use the FASTPAK 2 or LIFEPAK NiCd batteries require the Battery Support System 2 to perform battery conditioning. The FASTPAK battery technology remains unchanged. FASTPAK batteries require the Battery Support System or the Battery Support System 2 to perform battery conditioning.

Installing/Removing Batteries

WARNING!**Possible loss of power during patient care.**

Stored batteries lose charge. Failure to charge a stored battery before use may cause device power failure without warning. Always charge a stored battery before placing it in active use.

CAUTION!**Possible equipment damage.**

Battery pins in the defibrillator may be damaged if batteries are dropped or forced into battery wells. Inspect pins routinely for signs of damage.

To maximize battery life in the LIFEPAK 12 defibrillator/monitor:

- After use, replace both batteries with fully charged batteries; or, if the device was only used briefly, remove the battery in well 1 for recharging, move the battery in well 2 to the well 1 position, and install a fresh, fully charged battery in well 2.
- You may wish to charge batteries every week, even when device usage is light, and rotate all batteries in active use so they are used with equal frequency.

Routinely inspect batteries for damage or leakage. Discard/recycle damaged or leaking batteries.

To install batteries:

- 1 Inspect the battery pins in the battery wells for signs of damage.
- 2 Align the battery so that the battery clip is over the pins in the battery well.
- 3 Insert the end of the battery opposite the battery clip into the battery well.
- 4 Firmly press the other end of the battery into the battery well until it clicks into place.

To remove the battery, press the battery clip in and lift the battery out of the battery well.

MONITORING

This section describes the monitoring features of the LIFEPAK 12 defibrillator/monitor.

Monitoring the ECG	page 3-2
Acquiring a 12-Lead ECG	3-9
Monitoring SpO ₂	3-16
Monitoring Noninvasive Blood Pressure (NIBP)	3-24
Troubleshooting Tips for NIBP Monitoring	3-28
Monitoring Invasive Pressure (IP)	3-35
Monitoring Vital Signs (VS) and ST Changes	3-39

MONITORING THE ECG

The following paragraphs describe:

- ECG Monitoring Warning
- Selecting ECG Lead and Size
- Adjusting the Systole Volume
- Monitoring ECG with Paddles Accessories
- Monitoring with Patient ECG Cable
- Troubleshooting Tips for ECG Monitoring

ECG Monitoring Warning

WARNING!**Possible misinterpretation of ECG data.**

The frequency response of the monitor screen is intended only for basic ECG rhythm identification; it does not provide the resolution required for diagnostic and ST segment interpretation. For diagnostic or ST segment interpretation, or to enhance internal pacemaker pulse visibility, attach the 3-lead or 12-lead ECG cable. Then print the ECG rhythm in diagnostic frequency response (DIAG) or obtain a 12-lead ECG.

Selecting ECG Lead and Size

There are two methods for selecting or changing the ECG lead. One or both methods are available, depending on the configuration of your LIFEPAK 12 defibrillator/monitor:

To change ECG lead using the LEAD button:

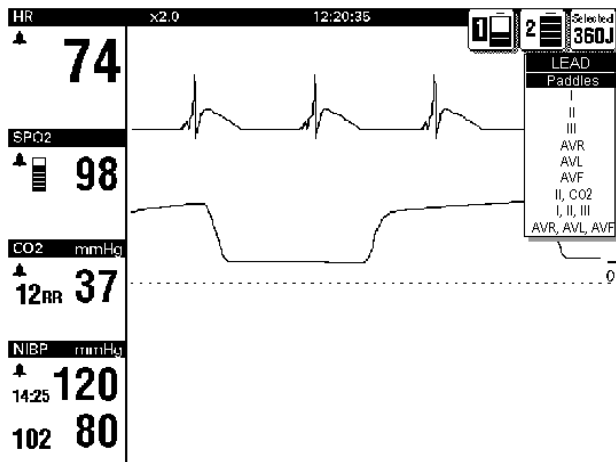

- 1 Press the LEAD button. If any ECG lead was displayed, the lead changes to Paddles. If Paddles lead was displayed, the lead changes to Lead II.
- 2 While the LEAD menu is displayed, press the LEAD button again or rotate the SELECTOR to select another lead. The highlighted selection shows the displayed ECG lead.

Note: When the VF/VT ALARM is on, you are limited to Paddles lead or Lead II in Channel 1. See "Setting Alarms" on page 2-22.

Note: If one or more lead sets are preconfigured for Channels 2 and 3, the lead sets will be available on the menu. See page 9-8 for information about configuring lead sets.

To select or change ECG lead using the SELECTOR:

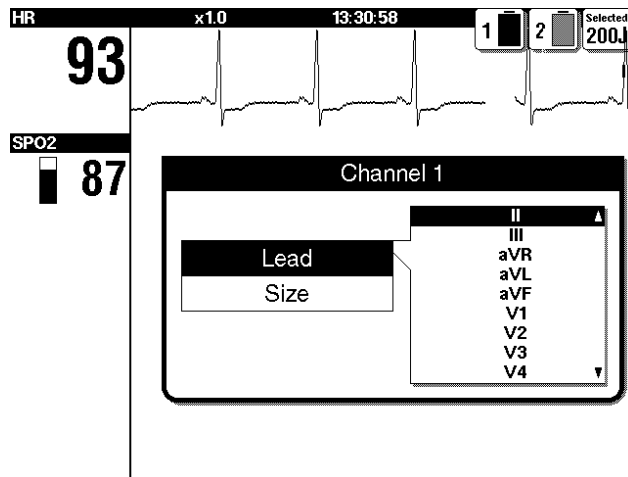

- 1 For the primary ECG, highlight and select Channel 1 and then LEAD.
- 2 Change ECG lead by rotating the SELECTOR. The highlighted selection shows the displayed ECG lead.
- 3 Repeat this procedure to select or change displayed waveforms for Channels 2 and 3.

Note: When the VF/VT ALARM is on, you are limited to Paddles lead or Lead II. See Setting Alarms, page 2-22.

There are two methods for selecting or changing ECG size. One or both methods are available, depending on the configuration of your LIFEPAK 12 defibrillator/monitor.

To select or change ECG size using the SIZE button:

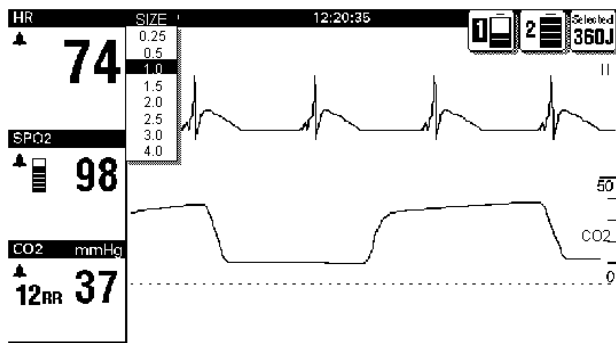

- 1 Press the SIZE button.
- 2 While the SIZE menu is displayed, press the SIZE button again or rotate the SELECTOR. The highlighted selection shows the current ECG size.

To select or change ECG size using the SELECTOR:

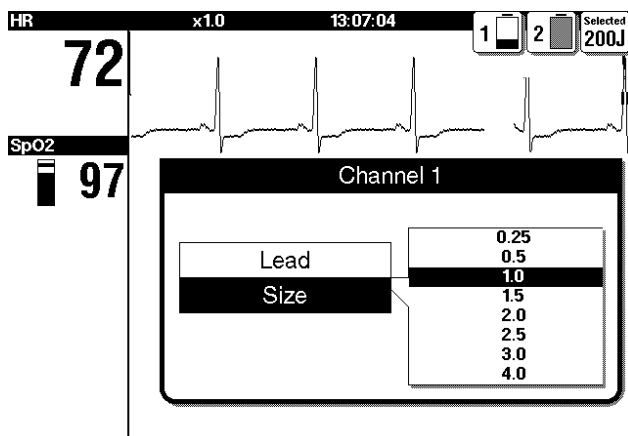

- 1 For the primary ECG, highlight and select Channel 1 and then SIZE.
- 2 Change ECG size by rotating the SELECTOR. The highlighted selection shows the current ECG size.

Adjusting the Systole Volume

To adjust the systole beep volume, highlight and select HR on the Home Screen.

The following overlay appears:

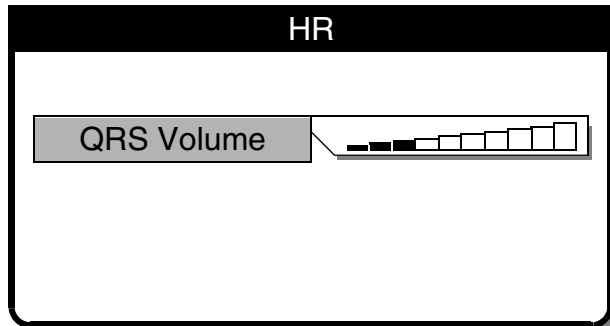

- 1 Select QRS VOLUME.
- 2 Rotate the SELECTOR to the desired volume.
- 3 Press the SELECTOR to set the volume.

Monitoring ECG with Paddles Accessories

Anterior-lateral Placement

Anterior-lateral placement is the only placement that should be used for ECG monitoring with paddles accessories.

- 1 Place either the ♥ or + therapy electrode, or APEX paddle lateral to the patient's left nipple in the midaxillary line, with the center of the electrode in the midaxillary line, if possible. See Figure 3-1.

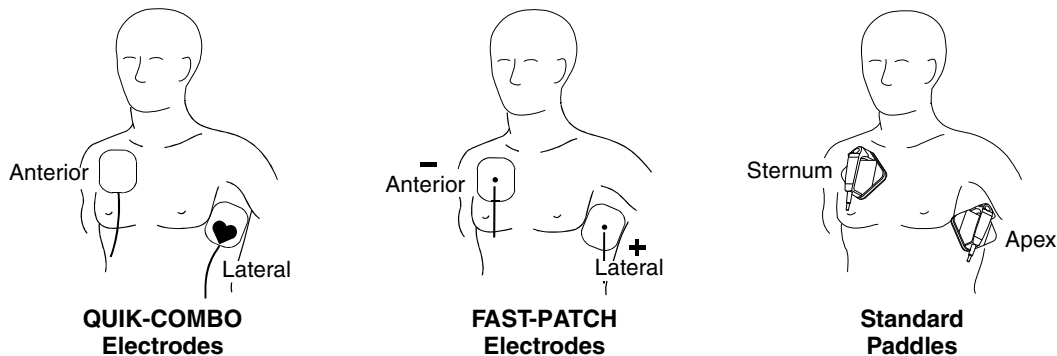

Figure 3-1 Anterior-lateral Placement

- 2 Place the other therapy electrode or STERNUM paddle on the patient's upper right torso, lateral to the sternum and below the clavicle as shown in Figure 3-1.

Special Placement Situations

When placing therapy electrodes or standard paddles, be aware of the special requirements in the following possible situations.

Obese Patients or Patients with Large Breasts. Apply therapy electrodes or standard paddles to a flat area on the chest, if possible. If skin folds or breast tissue prevent good adhesion, it may be necessary to spread skin folds apart to create a flat surface.

Thin Patients. Follow the contour of the ribs and spaces when pressing the therapy electrodes or standard paddles onto the torso. This limits air spaces or gaps under the electrodes and promotes good skin contact.

Patients with Implanted Pacemakers. If possible, place therapy electrodes or standard paddles away from internal pacemaker generator.

Patients with Implanted Defibrillators. Apply therapy electrodes or standard paddles in the anterior-lateral position and treat this patient as any other patient requiring emergency care.

Paddles Monitoring Procedure

To monitor using therapy electrodes or standard paddles:

- 1 Press **ON**. Adjust contrast if necessary.
- 2 Prepare the patient's skin:
 - Remove excessive chest hair as much as possible. Avoid nicking or cutting the skin. If possible, avoid placing therapy electrodes or standard paddles over broken skin.
 - Clean and dry the skin.
 - Do not use alcohol, tincture of benzoin, or antiperspirant to prep the skin.
- 3 Apply the therapy electrodes or standard paddles in the anterior-lateral position. For therapy electrodes, confirm that the package is sealed and the date is not expired. For standard paddles, apply conductive gel over the entire electrode surface.
- 4 Connect the therapy electrodes to the therapy cable.
- 5 Select **PADDLES** lead.

Monitoring with the Patient ECG Cable

There are three ECG cables available for ECG monitoring as shown in Figure 3-2: the 3-lead and 12-lead cables and the 5-wire cable.

Connecting the Patient ECG Cable

Connect the cable by inserting the main cable connector into the green electrically isolated ECG connector on the monitor. For the 12-lead cable, be sure the limb lead attachment is connected to the main cable. (If the precordial lead attachment is not needed, close the protective flap.)

To monitor using a precordial lead or to obtain a 12-lead ECG, connect the precordial lead attachment of the 12-lead cable.

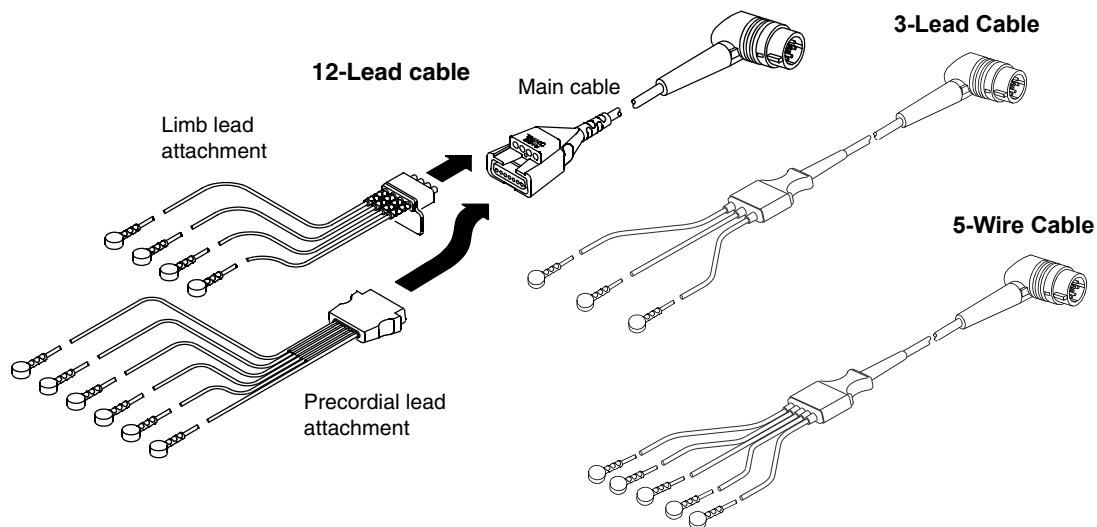

Figure 3-2 12-lead and 3-lead, and 5-wire ECG Cables

ECG Monitoring Procedure

- 1 Press **ON**. Adjust contrast if necessary.
- 2 Attach the ECG cable to the monitor.
- 3 Identify the appropriate electrode sites on the patient as shown in Figure 3-3.

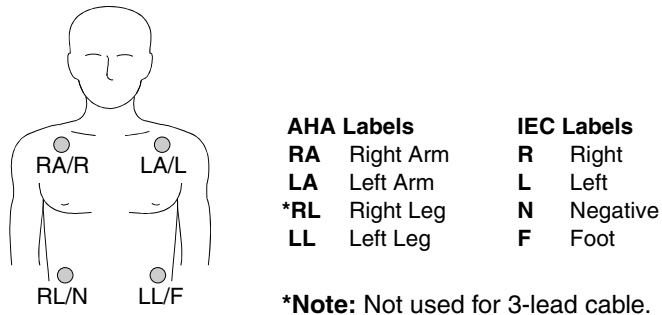

Figure 3-3 Limb Lead Electrode Placement

- 4 Prepare the patient's skin for electrode application:
 - Shave excessive hair at electrode site. Avoid locating electrodes over tendons and major muscle masses.
 - For oily skin, clean skin with alcohol pad.
 - Dry site with brisk rub.
- 5 Apply ECG electrodes:
 - Confirm package is sealed and date is not expired.
 - Attach an electrode to each of the lead wires.
 - Grasp electrode tab and peel electrode from carrier.
 - Inspect electrode gel and make sure gel is intact (discard electrode if gel is not intact).
 - Hold electrode taut with both hands. Apply the electrode flat to the skin. Smooth tape outwardly. Avoid pressing the center of the electrode.
 - Secure the trunk cable clasp to the patient's clothing.
- 6 Select the desired limb lead on the monitor screen.
- 7 If necessary, adjust ECG size for accurate heart rate counting.
- 8 Press **PRINT** to obtain an ECG printout.

Precordial Lead ECG Monitoring

The precordial (chest) leads (V1 through V6 for AHA, or C1 through C6 for IEC) can be used for monitoring when using the 12-lead cable.

- 1 Insert the precordial lead attachment into the main cable as shown in Figure 3-2.
- 2 Place the precordial lead electrodes on the chest as described in the 12-lead ECG procedure and shown in Figure 3-5 on page 3-10.

Note: When using a 5-wire cable, attach the limb leads as described in the ECG Monitoring procedure and place the C-lead electrode on the chest in the precordial position desired. However, the LIFEPAK 12 monitor does not recognize the C-lead and the ECG for this lead will be labeled V1 on the screen and printout regardless of the location of the C-lead electrode.

ECG Electrode Requirements

Electrode quality is critical for obtaining an undistorted ECG signal. Always check the date code on electrode packages for expiration date before using on a patient. Do not use electrodes with expired date codes. Disposable electrodes are intended for a single use.

For best ECG monitoring results, use silver/silver chloride (Ag/AgCl) ECG electrodes. Post-defibrillation display of ECG on the screen is faster using silver/silver chloride electrodes than with other electrode types.

Leads Off Messages

If an electrode or lead wire disconnects during ECG monitoring, the monitor emits an audible alarm and displays a leads off message. The ECG trace becomes a dashed line. The alarm and messages continue until the electrode or lead wire is replaced.

Color Coding for ECG Leads

The lead wires and the electrode snaps for the patient ECG cable are color coded according to AHA or IEC standards as listed in Table 3-1.

Table 3-1 ECG Leads Color Codes

Leads	AHA Label	AHA Color	IEC Label	IEC Color
Limb Leads	RA	White	R	Red
	LA	Black	L	Yellow
	RL	Green	N	Black
	LL	Red	F	Green
Precordial Leads	V1	Red	C1	Red
	V2	Yellow	C2	Yellow
	V3	Green	C3	Green
	V4	Blue	C4	Brown
	V5	Orange	C5	Black
	V6	Violet	C6	Violet

Monitoring Patients with Internal Pacemakers

The LIFEPAK 12 defibrillator/monitor typically does not use internal pacemaker pulses to calculate the heart rate. However, when using therapy electrodes or standard paddles to monitor in paddles lead, the monitor may detect internal pacemaker pulses as QRS complexes. This may result in an inaccurate heart rate display.

Smaller amplitude internal pacemaker pulses may not be distinguished clearly in paddles lead. For improved detection and visibility of internal pacemaker pulses, turn on the **INTERNAL PACEMAKER** detector, and/or connect the ECG cable, select an ECG lead and print the ECG in diagnostic frequency response.

Large amplitude pacemaker pulses may overload the QRS complex detector circuitry so that no paced QRS complexes are counted. To help minimize ECG pickup of large unipolar pacemaker pulses when monitoring patients with internal pacemakers, place ECG electrodes so the line between the positive and negative electrodes is perpendicular to the line between the pacemaker generator and the heart.

The internal pacemaker detection feature can be used to help identify internal pacemaker pulses on the printed ECG. When enabled, this feature uses lead V4 to detect internal pacer pulses. If V4 is not available because it is not attached or is too noisy, lead II is used, if available. If this feature is configured or selected **ON**, the LIFEPAK 12 defibrillator/monitor annotates a hollow arrow  on the printed ECG if internal pacemaker pulses are detected. False annotations of this arrow may occur if ECG artifacts mimic internal pacer pulses. If false annotations occur, you may deactivate the detection feature using the **OPTIONS / PACING / INTERNAL PACER** menu (see Figure 2-5). Patient history and other ECG waveform data, such as wide QRS complexes, should be used to verify the presence of an internal pacemaker. For information about configuring the internal pacemaker detection, refer to the Pacing Setup menu in Table 9-4.

Troubleshooting Tips for ECG Monitoring

If problems occur while monitoring the ECG, check the list of observations in Table 3-2 for aid in troubleshooting. For basic troubleshooting problems such as no power, refer to "General Troubleshooting Tips" on page 8-12.

Table 3-2 Troubleshooting Tips for ECG Monitoring

Observation	Possible Cause	Corrective Action
1 Screen blank and ON LED lighted.	CONTRAST needs adjustment.	<ul style="list-style-type: none"> Adjust contrast.
	Screen not functioning properly.	<ul style="list-style-type: none"> Print ECG on recorder as backup. Contact service personnel for repair.
2 Any of these messages displayed: CONNECT ELECTRODES CONNECT ECG LEADS ECG LEADS OFF XX LEADS OFF	Therapy electrodes not connected.	<ul style="list-style-type: none"> Confirm therapy electrode connections.
	One or more ECG electrodes disconnected.	<ul style="list-style-type: none"> Confirm ECG electrode connections.
	ECG cable is not connected to monitor.	<ul style="list-style-type: none"> Confirm ECG cable connections.
	Poor electrode-to-patient adhesion.	<ul style="list-style-type: none"> Reposition cable and/or lead wires to prevent electrodes from pulling away from patient. Prepare skin and apply new electrodes.
	Broken ECG cable lead wire.	<ul style="list-style-type: none"> Select another lead. Select PADDLES lead and use standard paddles or therapy electrodes for ECG monitoring. Check ECG cable continuity.
3 Poor ECG signal quality.	Poor electrode-skin contact.	<ul style="list-style-type: none"> Reposition cable and/or lead wires to prevent electrodes from pulling away from patient. Secure trunk cable clasp to patient's clothing. Prepare skin and apply new electrodes.
	Outdated, corroded, or dried-out electrodes.	<ul style="list-style-type: none"> Check date codes on electrode packages. Use only unexpired silver/silver chloride electrodes. Leave electrodes in sealed pouch until time of use.
	Loose connection.	<ul style="list-style-type: none"> Check/reconnect cable connections.
	Damaged cable or connector/lead wire.	<ul style="list-style-type: none"> Inspect ECG and therapy cables. Replace if damaged. Check cable with simulator and replace if malfunction observed.
	Noise because of radio frequency interference (RFI).	<ul style="list-style-type: none"> Check for equipment causing RFI (such as a radio transmitter) and relocate or turn off equipment power.
4 Baseline wander (low frequency/high amplitude artifact).	Inadequate skin preparation.	<ul style="list-style-type: none"> Prepare skin and apply new electrodes.
	Poor electrode-skin contact.	<ul style="list-style-type: none"> Check electrodes for proper adhesion.
	Diagnostic frequency response.	<ul style="list-style-type: none"> Print ECG in monitor frequency response.

Table 3-2 Troubleshooting Tips for ECG Monitoring (Continued)

Observation	Possible Cause	Corrective Action
5 Fine baseline artifact (high frequency/low amplitude).	Inadequate skin preparation.	<ul style="list-style-type: none"> • Prepare skin and apply new electrodes.
	Isometric muscle tension in arms/legs.	<ul style="list-style-type: none"> • Confirm that limbs are resting on a supportive surface. • Check electrodes for proper adhesion.
6 Systole beeps not heard or do not occur with each QRS complex.	Volume too low.	<ul style="list-style-type: none"> • Adjust volume.
	QRS amplitude too small to detect.	<ul style="list-style-type: none"> • Adjust ECG size.
7 Monitor displays dashed lines with no ECG leads off messages.	PADDLES lead selected but patient connected to ECG cable.	<ul style="list-style-type: none"> • Select one of the limb or precordial leads.
8 Heart rate (HR) display different than pulse rate.	ECG size set too high or too low.	<ul style="list-style-type: none"> • Adjust ECG size up or down.
	Monitor detecting the patient's internal pacemaker pulses.	<ul style="list-style-type: none"> • Change monitor lead to reduce internal pacemaker pulse size.
9 Internal pacemaker pulses difficult to see.	Pacemaker pulses are very small from pacemaker.	<ul style="list-style-type: none"> • Turn on internal pacemaker detector (see page 2-9).
	Monitor frequency response limits visibility.	<ul style="list-style-type: none"> • Connect ECG cable and select ECG lead instead of PADDLES. • Print ECG in diagnostic mode (see page 2-9).

ACQUIRING A 12-LEAD ECG

The following paragraphs describe:

- 12-Lead ECG Warning
- Identifying Electrode Sites
- 12-Lead ECG Procedure
- 12-Lead ECG Reports
- Troubleshooting Tips for 12-Lead ECG

12-Lead ECG Warning

WARNING!

Possible inability to obtain a diagnostic 12-lead ECG.

Using previously unpackaged electrodes or electrodes with expired date codes may impair ECG signal quality. Remove electrodes from a sealed package immediately before use and follow the procedure for applying the electrodes.

Identifying Electrode Sites

To obtain a 12-lead ECG, place the electrodes on the limbs and the chest (precordium), as described in the following paragraph.

Limb Lead Electrode Sites

When acquiring a 12-lead ECG, limb lead electrodes are typically placed on the wrists and ankles as shown in Figure 3-4. The limb lead electrodes can be placed anywhere along the limbs. Do not place the limb lead electrodes on the torso when acquiring a 12-lead ECG.

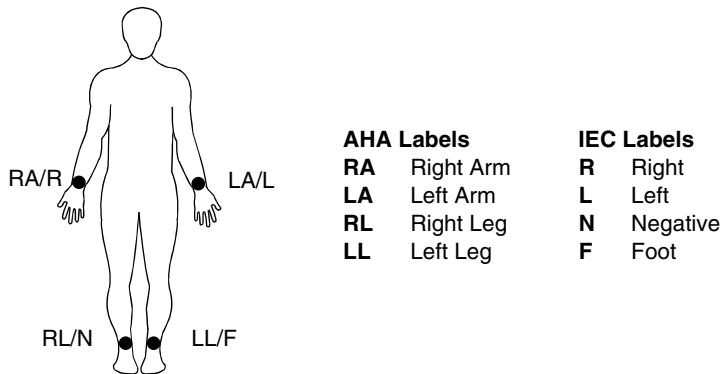

Figure 3-4 Limb Lead Electrode Placement for 12-lead ECG

Precordial Lead Electrode Sites

The six precordial (chest) leads are placed on specific locations as shown in Figure 3-5 and summarized in Table 3-3. Proper placement is important for accurate diagnosis and should be identified as follows (leads are V1 through V6 for AHA, or C1 through C6 for IEC; refer to Table 3-1, page 3-7 for color codes).

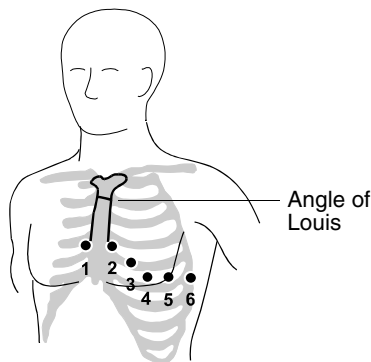

Table 3-3 Precordial Lead Electrode Placement

Lead	Location
V1 C1	Fourth intercostal space to the right of the sternum
V2 C2	Fourth intercostal space to the left of the sternum
V3 C3	Directly between leads V2/C2 and V4/C4
V4 C4	Fifth intercostal space at midclavicular line
V5 C5	Level with V4/C4 at left anterior auxiliary line
V6 C6	Level with V5/C5 at left midaxillary line

Figure 3-5 Precordial Lead Electrode Placement

Locating the V1/C1 position (fourth intercostal space) is critically important because it is the reference point for locating the placement of the remaining V/C leads. To locate the V1/C1 position:

- 1 Place your finger at the notch in the top of the sternum.
- 2 Move your finger slowly downward about 1.5 inches (3.8 centimeters) until you feel a slight horizontal ridge or elevation. This is the Angle of Louis where the manubrium joins the body of the sternum.
- 3 Locate the second intercostal space on the patient's right side, lateral to and just below the Angle of Louis.
- 4 Move your finger down two more intercostal spaces to the fourth intercostal space, which is the V1/C1 position.
- 5 Continue locating other positions from V1 (see Table 3-3).

Other important considerations:

- When placing electrodes on female patients, always place leads V3-V6 and C3-C6 *under* the breast rather than *on* the breast.
- Never use the nipples as reference points for locating the electrodes for men or women patients, because nipple locations may vary widely.

12-Lead ECG Procedure

WARNING!

Possible inaccurate diagnosis.

If the patient is 15 years of age or younger and the age is not entered for a 12-lead ECG, the interpretive statements will be based on adult criteria and the 12-lead algorithm may render incorrect statements.

To acquire a 12-lead ECG:

- 1 Press ON.
- 2 Insert the limb lead and the precordial lead attachments into the main cable as shown in Figure 3-6.

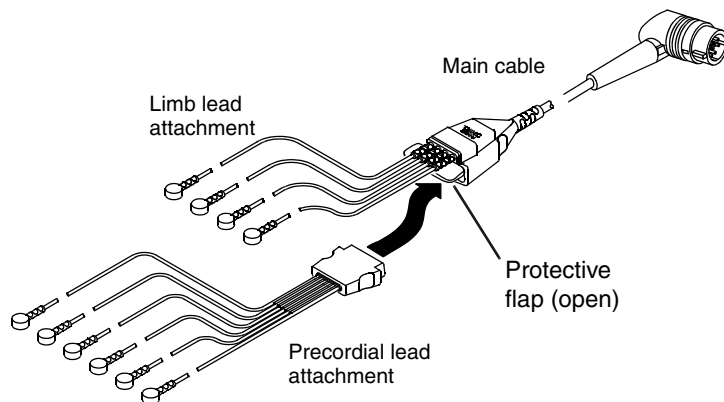

Figure 3-6 12-Lead ECG Cable

- 3 Insert the cable connector into the green **ELECTRICALLY ISOLATED ECG** connector on the monitor.
- 4 Prepare patient's skin for electrode application as described on page 3-6.
- 5 Apply ECG electrodes as described on page 3-6.
- 6 Encourage the patient to remain as still as possible.
- 7 Press 12-LEAD.

The 12-LEAD / AGE menu appears, prompting you to enter the patient's age. If you do not enter an age, 40 years is selected automatically. Always enter the patient's age if the patient is 15 years of age or younger. Use the SELECTOR to enter the patient's age in years (1 to 125) or, for infants, select from the list of ages less than 1 year.

1 day	2–6 days	1–3 weeks	1 month	2 months
3 months	4 months	5 months	6–8 months	9–11 months

- 8 If the monitor detects signal noise (such as patient motion or a disconnected electrode), the 12-lead acquisition is interrupted until noise is removed. Take appropriate action as required to eliminate noise, or press 12-LEAD again to override. Troubleshooting tips are provided in Table 3-4.
- 9 A 12-lead ECG report automatically prints if so configured. (See Table 9-10).

Note: If 15 years or less is entered for patient age, the 12-lead ECG will print at diagnostic frequency response of 0.05–150 Hz, even if 0.05–40 Hz is configured as the print default.

Data Acquisition Mode

The defibrillator requires 10 seconds of ECG data for each 12-lead ECG requested. The monitor can be configured to analyze the 10 seconds of data *before* you press 12-LEAD (the PRE option) or 10 seconds of data *after* you press 12-LEAD (the POST option).

ECG Override

If the monitor detects signal noise while acquiring data (such as patient motion or a disconnected electrode), the screen displays the message NOISY DATA! PRESS 12-LEAD TO ACCEPT. This message remains as long as signal noise is detected. When signal noise is eliminated, the monitor resumes acquiring data. If the signal noise persists for longer than 30 seconds, the 12-lead acquisition stops. The screen displays EXCESSIVE NOISE-12-LEAD CANCELLED. You must then press 12-LEAD to restart 12-lead ECG acquisition.

While the monitor displays the message NOISY DATA! PRESS 12-LEAD TO ACCEPT, you can choose to press 12-LEAD again and force the monitor to acquire the 12-lead ECG report regardless of detected signal noise or disconnected leads. Any 12-lead ECG reports acquired in this way are annotated with the following message:

ECG OVERRIDE: DATA QUALITY PROHIBITS INTERPRETATION

No interpretation information prints on this type of 12-lead ECG report.

Note: Under certain conditions, particularly if 12-LEAD is pressed immediately after electrode application, the screen may display the message NOISY DATA. This may be due to a brief period of chemical instability between the electrodes and the patient that is not viewable on the ECG monitor screen but is detected as noisy data by the diagnostic frequency response filter used during 12-lead acquisition. In general, it is best to wait at least 30 seconds after applying the last electrode before pressing the 12-LEAD button. Also, good skin preparation will shorten the stabilization time.

12-Lead ECG Reports

The monitor prints the 12-lead ECG report in a 3-channel or 4-channel format. To select the desired format for the current patient, see "Printing a Current Patient Report" on page 6-9. For printing from the patient archives, see "Printing Archived Patient Reports" on page 6-15.

To protect reports after printing:

- Avoid extended exposure to direct sunlight
- Do not store in plastic folders (use paper only)
- Do not apply tape or adhesives to the printed side

An ECG leads-off condition for any lead is indicated on the report by a dashed line.

Two diagnostic frequency responses (or bandwidths) are available in setup for printing the 12-lead ECG: 0.05–40 Hz and 0.05–150 Hz. The frequency response of 0.05–150 Hz is the Association for the Advancement of Medical Instrumentation (AAMI) standard for diagnostic ECGs. The 0.05–40 Hz setting preserves the low frequency limit that is needed for the diagnosis of myocardial ischemia and infarction *while* reducing high frequency artifact (in particular patient muscle tension) to help make the diagnostic printout less noisy and more readable.

The 12-lead ECG printed in the 0.05–40 Hz setting can be used to diagnose acute myocardial ischemia and infarction. This is because the low frequency limit of 0.05 Hz is not changed from the standard diagnostic setting of 0.05–150 Hz. The 0.05 Hz frequency provides accurate representation of low frequency signals, that is, the P, ST segment, and T waves. The presence or absence of ST segment changes indicative of myocardial ischemia or infarction will be accurately reproduced. In addition, the criteria for visual analysis and interpretation of cardiac rhythm and PR, QRS, and QT intervals are preserved as is true with cardiac monitors with an upper frequency limit of 40 Hz.

However, in *some* adult patients, the amplitude (that is, voltage) of the QRS may be reduced when 12-lead ECGs are printed at 0.05–40 Hz. Therefore, ECG diagnosis, which depends on R wave amplitude (for example, ventricular hypertrophy), should not be made using this setting. In the pediatric patient, this effect on R wave amplitude is particularly noticeable because QRS durations are typically quite narrow. Because R wave amplitude reduction is more likely with pediatric patients, the 12-lead

ECG will automatically print at 0.05–150 Hz, overriding the 40 Hz limit, when a patient age of 15 years or younger is entered.

To change the diagnostic frequency response at which 12-lead ECGs are printed, refer to Table 9-10.

The 3-Channel Format

Figure 3-7 is an example of a 12-lead ECG report printed in the standard 3-channel format that includes 2.5 seconds of data from each of the 12 leads. The sequence of leads for the 3-channel format is always printed in the order shown in Figure 3-7. Twelve-lead ECG reports are always acquired and printed in diagnostic frequency response.

The 12-lead report can also be printed in a 3-channel Cabrera view (see Figure 3-8). To set the 12-lead printout to the Cabrera view, refer to Table 9-10.

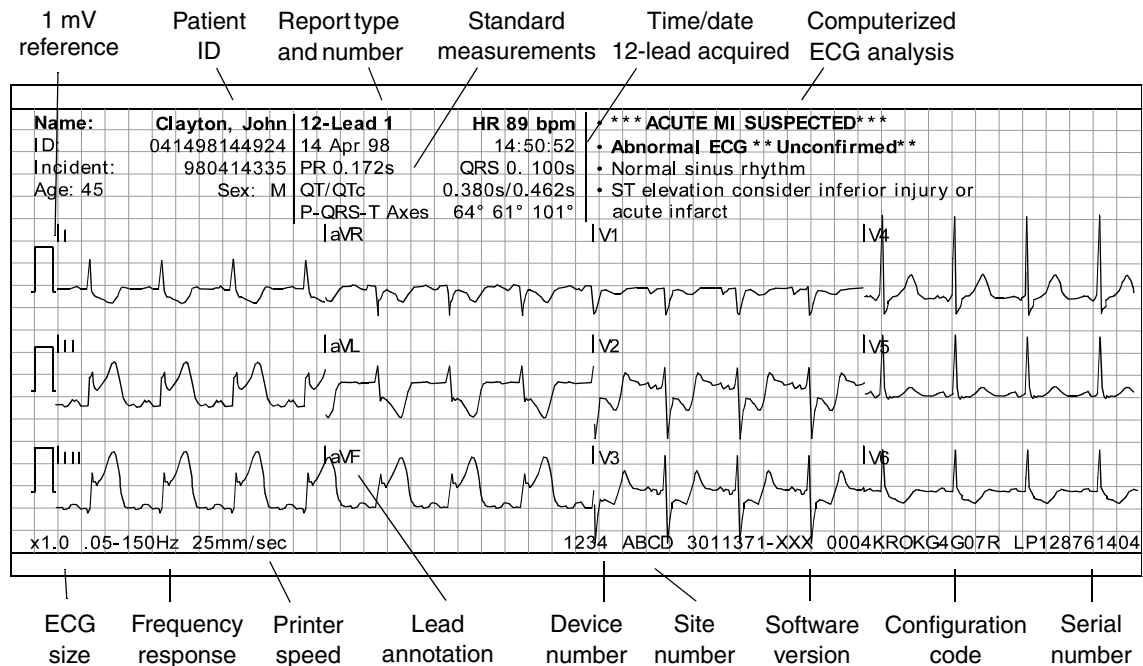

Figure 3-7 Example of Printed, Standard, 3-Channel, 12-Lead ECG Report

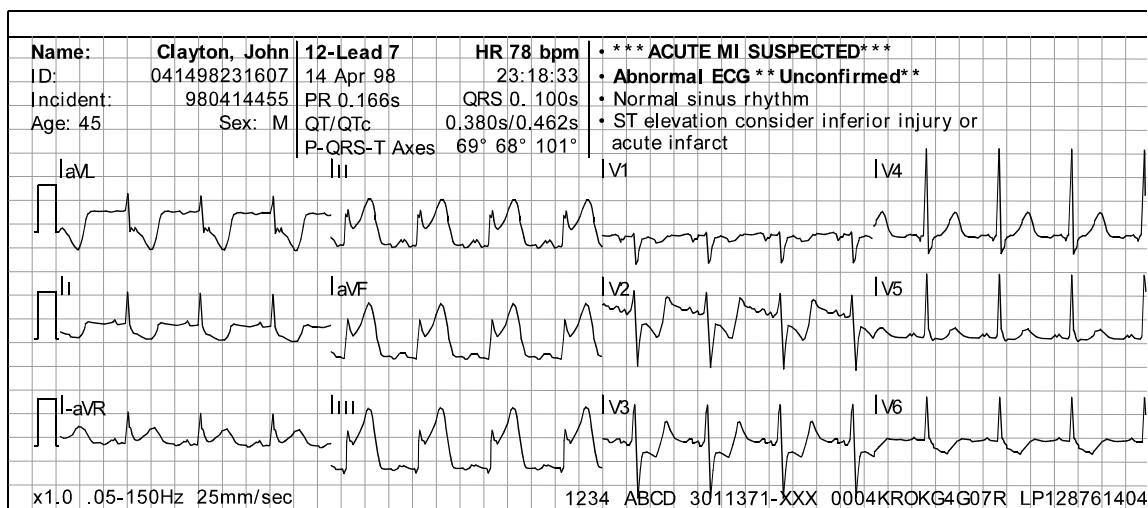

Figure 3-8 Example of Printed, Cabrera, 3-Channel, 12-Lead ECG Report

The 4-Channel Format

Figure 3-9 and Figure 3-10 are examples of 12-lead ECG reports printed in the 4-channel format. The 4-channel format consists of the median complex (or median beat) derived for each of the 12 leads and 10 seconds of data for Lead II.

Note: The fiducial marks displayed in the 4-channel format identify the measurement intervals used for the interpretive statements of the analysis program. These marks are part of the analysis program and cannot be turned off.

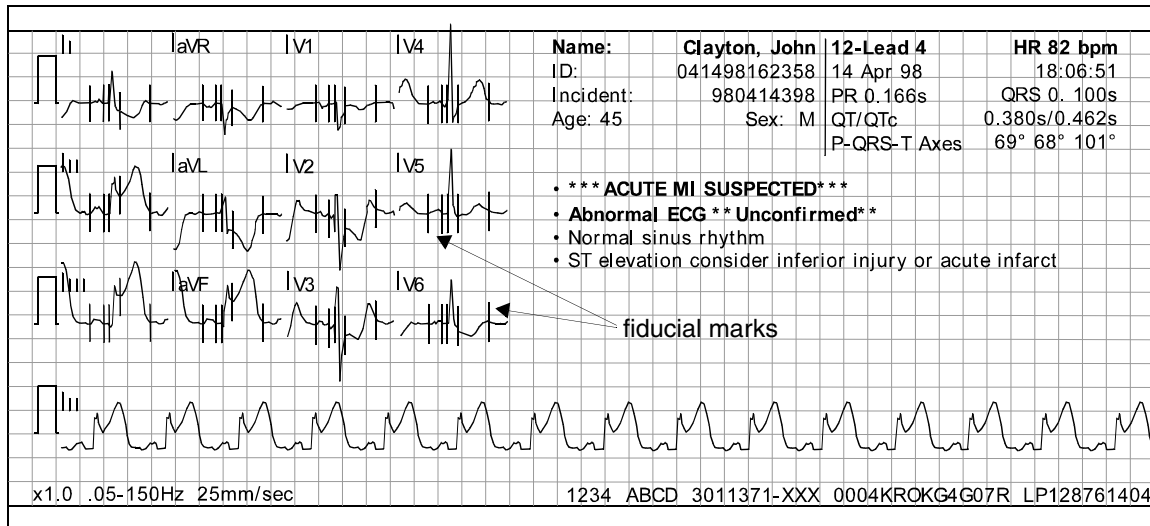

Figure 3-9 Example of Printed, Standard, 4-Channel, 12-Lead ECG Report

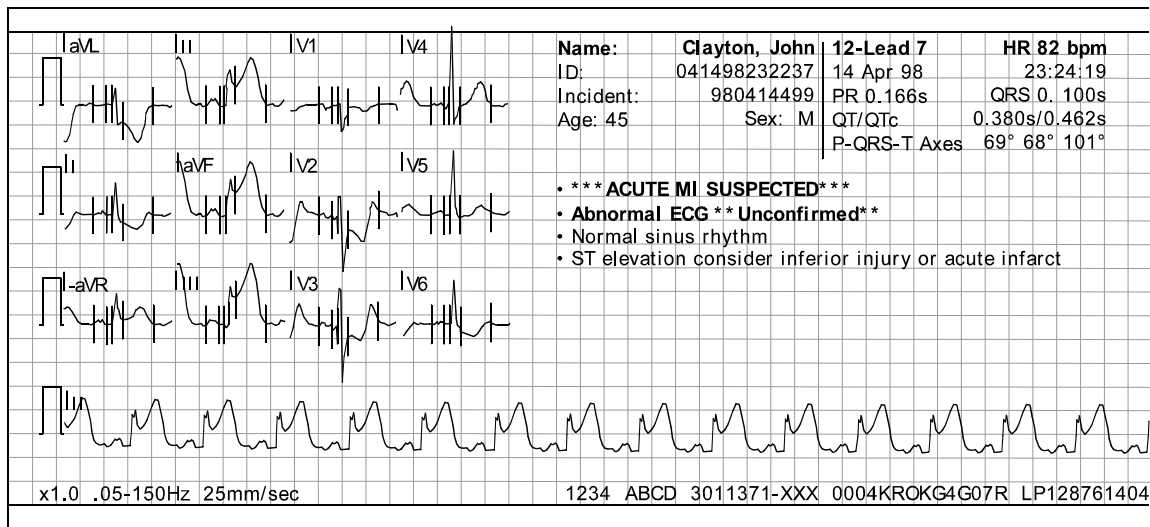

Figure 3-10 Example of Printed, Cabrera, 4-Channel, 12-Lead ECG Report

Computerized ECG analysis

Computerized ECG analysis statements are available for printing on LIFEPAK 12 monitor 12-lead ECG reports. The interpretation statements pertaining to myocardial injury, infarct, and ischemia are derived from measurements made on a signal-averaged beat (median beat) formed for each of the 12 leads. The computerized ECG analysis selects three representative beats from the ten seconds of

data for each lead and averages the three beats to derive the median beat for that lead. The ECG analysis is always based on ECG data obtained at 0.05–150 Hz frequency response.

The Analysis Program is adjusted for patient age. If no age is manually entered, an age of 40 years is automatically selected. Infant ages may be entered as described on page 3-11. The interpretive algorithm for the LIFEPAK 12 monitor 12-lead ECG feature is the 12SL™ ECG analysis program of GE Medical Systems. For more information, refer to the *12SL™ ECG Analysis Program Physician's Guide*.

Another set of 12-lead statements, the Simoons statements, are available for customers outside the USA only. The Simoons interpretive statements focus on reperfusion therapy recommendations and suppress the 12SL ECG analysis program statements, but not the *****ACUTE MI SUSPECTED***** message. The Simoons analysis program is not intended for use on pediatric patients.

Computerized ECG analysis should not be used to withhold or prescribe patient treatment without review by qualified medical personnel. All 12-lead ECG interpretation statements provided by the LIFEPAK 12 monitor include the printed message ****UNCONFIRMED****.

Troubleshooting Tips for 12-Lead ECG

Table 3-4 Troubleshooting Tips for 12-lead ECG

Observation	Possible Cause	Corrective Action
1 Any of these messages displayed: CONNECT ECG LEADS ECG LEADS OFF XX LEADS OFF	One or more ECG electrodes disconnected.	<ul style="list-style-type: none"> • Confirm ECG electrode connections.
	ECG cable is not connected to monitor.	<ul style="list-style-type: none"> • Confirm ECG cable connections.
	Poor electrode-to-patient adhesion.	<ul style="list-style-type: none"> • Reposition cable and/or lead wires to prevent electrodes from pulling away from patient. • Prepare skin and apply new electrodes.
	Broken lead wire.	<ul style="list-style-type: none"> • Select another lead. • Select PADDLES lead and use standard paddles or therapy electrodes for ECG monitoring. • Check ECG cable continuity.
2 Noisy signal and/or message displayed: NOISY DATA! PRESS 12-LEAD TO ACCEPT	Noise in a lead(s) other than the displayed lead.	<ul style="list-style-type: none"> • Press 12-LEAD again to override the message. Examine the printout to determine which lead(s) affected by noise. Replace or reposition the affected electrode(s) and lead wire(s).
	Poor electrode-skin contact.	<ul style="list-style-type: none"> • Reposition cable and/or lead wires to prevent electrodes from pulling away from patient. • Secure trunk cable clasp to patient's clothing. • Prepare skin and apply new electrodes.
	Loose connection.	<ul style="list-style-type: none"> • Check/reconnect cable connections.
	Patient motion.	<ul style="list-style-type: none"> • Encourage patient to lie quietly. • Support patient's limbs.
	Vehicle motion.	<ul style="list-style-type: none"> • Stop vehicle while acquiring 12-lead ECG data.
	Outdated, corroded, or dried-out electrodes.	<ul style="list-style-type: none"> • Check date codes on electrode packages. • Use only unexpired silver/silver chloride electrodes. Leave electrodes in sealed pouch until time of use.
	Radio Frequency Interference (RFI).	<ul style="list-style-type: none"> • Check for equipment causing RFI (such as a radio transmitter) and relocate or turn off equipment power.
Damaged cable or connector/lead wire.	<ul style="list-style-type: none"> • Inspect main cable and attachments. Replace if damaged. 	

Monitoring

Table 3-4 Troubleshooting Tips for 12-lead ECG (Continued)

Observation	Possible Cause	Corrective Action
3 Monitor does not complete 12-lead ECG operation sequence.	Operator pressed another function button (such as PRINT) before 12-lead ECG sequence completed.	<ul style="list-style-type: none"> Press 12-LEAD to acquire another 12-lead ECG. Allow enough time for sequence to complete.
4 Noisy signal and message displayed: EXCESSIVE NOISE-12-LEAD CANCELLED	Signal noise for more than 30 seconds.	<ul style="list-style-type: none"> Press 12-LEAD to acquire another 12-lead ECG.
5 Baseline wander (low frequency/high amplitude artifact).	Inadequate skin preparation.	<ul style="list-style-type: none"> Prepare skin as described on page 3-6 and apply new electrodes.
	Poor electrode-skin contact.	<ul style="list-style-type: none"> Check electrodes for proper adhesion.
6 Fine baseline artifact (high frequency/low amplitude).	Inadequate skin preparation.	<ul style="list-style-type: none"> Prepare skin as described on page 3-6 and apply new electrodes.
	Isometric muscle tension in arms/legs.	<ul style="list-style-type: none"> Confirm that limbs are resting on a supportive surface. Check electrodes for proper adhesion.

MONITORING SpO2

The following paragraphs describe:

- SpO2 Warnings and Cautions
- When to Use a Pulse Oximeter
- How a Pulse Oximeter Works
- SpO2 Monitoring Considerations
- Masimo® SpO2 Monitoring Procedure
- Nellcor® SpO2 Monitoring Procedure
- Pulse Oximeter Sensors
- Troubleshooting Tips for SpO2

SpO2 Warnings and Cautions

WARNINGS!

Shock or burn hazard.

Before use, carefully read these Operating Instructions, the sensor and extension cable directions for use, and precautionary information.

Shock or burn hazard.

Other manufacturers' oxygen transducers may cause improper oximeter performance and invalidate safety agency certification. Use only oxygen transducers approved for this product.

Inaccurate pulse oximeter readings.

Do not use a damaged extension cable or one with exposed electrical contacts. Never use more than one extension cable between the pulse oximeter and the sensor.

Inaccurate pulse oximeter readings.

Do not use a damaged sensor. Do not alter the sensor in any way. Alterations or modifications may affect performance and/or accuracy.

WARNINGS!**Inaccurate pulse oximeter readings.**

Sensors exposed to ambient light when incorrectly applied to a patient may exhibit inaccurate saturation readings. Securely place the sensor on the patient and check the sensor's application frequently to help ensure accurate readings.

Inaccurate pulse oximeter readings.

Severe anemia, significant blood levels of carboxyhemoglobin or methemoglobin, intravascular dyes that change usual blood pigmentation, excessive patient movement, venous pulsations, electrosurgical interference, exposure to irradiation and placement of the sensor on an extremity that has a blood pressure cuff, intravascular line or externally applied coloring (such as nail polish) may interfere with oximeter performance. The operator should be thoroughly familiar with the operation of the oximeter prior to use.

Inaccurate pulse oximeter readings.

The pulsations from intra-aortic balloon support can be additive to the pulse rate on the oximeter pulse rate display. Verify patient's pulse rate against the ECG heart rate.

Skin injury.

Prolonged, continuous use of a sensor may cause irritation, blistering, or pressure necrosis of the skin. Check the sensor site regularly based on patient condition and type of sensor. Change the sensor site if skin changes occur. Do not use tape to hold the sensor in place, as this may cause inaccurate readings or damage to the sensor or skin.

Possible strangulation.

Carefully route patient cabling to reduce the possibility of patient entanglement or strangulation.

CAUTION!**Possible equipment damage.**

To avoid damaging the extension cable or the sensor, hold the connectors, rather than the cables, when disconnecting.

No Implied License

Possession or purchase of this oximeter does not convey any express or implied license to use the oximeter with replacement parts that, alone or in combination with the oximeter, would fall within the scope of one or more of the patents relating to this device.

When to Use a Pulse Oximeter

A pulse oximeter is a noninvasive device that checks the saturation of oxygen in arterial blood (SpO₂). It is used for monitoring patients who are at risk of developing hypoxemia. If a pulse oximeter is not used, the only indications of hypoxemia are a patient's dusky skin, nail beds, and mucous membranes, accompanied by restlessness and confusion. These indications are not conclusive, however, and do not appear until after the patient has developed hypoxemia. Pulse oximetry is to be used in addition to patient assessment. Care should be taken to assess the patient at all times and not rely solely on the SpO₂ reading. If a trend toward patient deoxygenation is indicated, blood samples should be analyzed using laboratory instruments to completely understand the patient's condition.

Do not use the pulse oximeter to monitor the patient for apnea.

How a Pulse Oximeter Works

A pulse oximeter sensor directs light through a patient's fleshy body site (usually the finger or earlobe). The sensor sends light from the emitting diodes to the receiving detector as shown in Figure 3-11. Oxygen saturated blood absorbs light differently as compared to unsaturated blood. The pulse

oximeter translates the amount of light received into a saturation percentage and displays an SpO₂ reading. Normal values typically range from 95% to 100% at sea level.

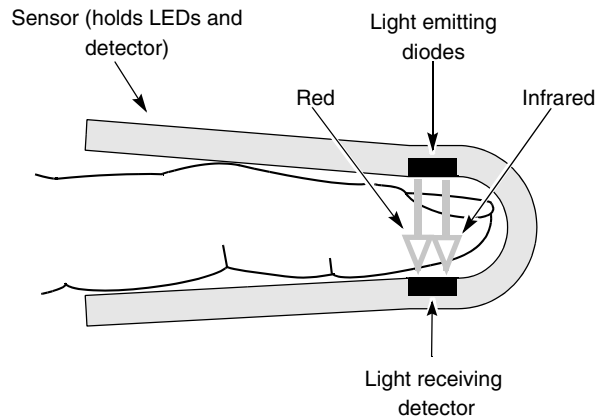

Figure 3-11 How a Pulse Oximeter Works

The quality of the SpO₂ reading depends on correct sensor size and placement, adequate blood flow through the sensor site, and limiting patient motion and exposure to ambient light. For example, with very low perfusion at the monitored site, readings may read lower than core arterial oxygen saturation. Test methods for accuracy are available by contacting your local Physio-Control representative.

SpO₂ Monitoring Considerations

Each oximeter sensor is designed to be applied to a specific site on a patient according to patient weight. Use the following criteria to select the appropriate sensor:

- Patient weight
- Patient perfusion to extremities
- Patient activity level
- Available application sites on the patient's body
- Sterility requirements
- Anticipated duration of monitoring

To help ensure optimal and accurate performance:

- Use a dry and appropriately sized sensor.
- Keep the sensor site at the same level as the patient's heart.
- Apply it according to the Directions for Use provided with the sensor.
- Observe all warnings and cautions noted in the sensor's Directions for Use.

Note: Wrapping the sensor too tightly or using supplemental tape to hold the sensor in place may cause inaccurate SpO₂ readings.

Note: Circulation distal to the sensor site should be checked routinely.

The sensors are sensitive to light. If excessive ambient light is present, cover the sensor site with an opaque material to block the light. Failure to do so could result in inaccurate measurements.

If patient movements present a problem, consider the following possible solutions:

- Be sure the sensor is secure and properly aligned.
- Use a new sensor with fresh adhesive backing.
- If possible, move the sensor to a less active site.

Masimo SpO₂ Monitoring Procedure

Power to the pulse oximeter is controlled by the LIFEPAK 12 defibrillator/monitor. When the defibrillator is turned on, the oximeter turns on and performs a self-test that requires up to 10 seconds. When the defibrillator is turned off, the oximeter also turns off.

To conserve battery power, the pulse oximeter goes into “sleep mode” when not in use. Sleep mode is activated within 10 seconds of disconnecting the sensor. The oximeter will return to normal mode after detecting a sensor or a patient signal. The oximeter performs the self-test when it returns from sleep mode to active mode. During sleep mode, the screen does not display SpO2 information.

The pulse oximeter measures SpO2 levels between 1% and 100%. When SpO2 levels are between 70% and 100%, oximeter measurements are accurate from ± 3 digits.

- 1 Connect the SpO2 cable to the monitor.
- 2 Attach the sensor to the SpO2 cable and the patient.
- 3 Press ON.
- 4 Observe the pulse bar for fluctuation. Amplitude of the pulse bar indicates relative signal strength.
- 5 Adjust sensitivity, averaging time, and SpO2 volume as necessary.

SpO2 Waveform

The SpO2 waveform can be displayed on waveform Channel 2 by selecting waveform CHANNEL 2 and then selecting SPO2 from the Waveform menu. The SpO2 waveform automatically sizes itself to provide optimum waveform viewing.

Note: LIFEPAK 12 defibrillator/monitors with a 50 mm printer can display the SpO2 pleth waveform (in Channel 2 only) but cannot print it. Only monitors with a 100 mm printer can print this waveform.

SpO2 Volume

To adjust the pulse tone volume, highlight and select SPO2 on the home screen.

The following overlay appears:

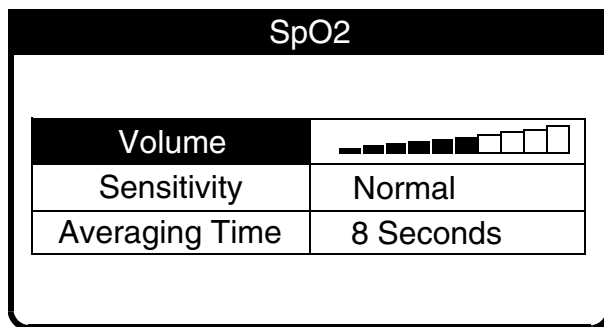

- 1 Highlight and select SPO2 VOLUME.
- 2 Rotate the SELECTOR to the desired volume.
- 3 Press the SELECTOR to set the volume.

Sensitivity

The sensitivity setting allows you to adjust the oximeter for differing perfusion states. To adjust the sensitivity to either normal or high, highlight and select SPO2 on the home screen and then select SENSITIVITY.

The normal sensitivity setting is the recommended setting for most patients. The high sensitivity setting allows for SpO2 monitoring under low perfusion states such as the severe hypotension of shock. However, when the SpO2 sensitivity is set to high, the signal is more susceptible to artifact. It is recommended that the patient be monitored closely when the high sensitivity setting is in use.

Averaging Time

The averaging time setting allows you to adjust the time period used to average the SpO2 value. Four time periods are provided for averaging: 4, 8, 12, and 16 seconds. To adjust the averaging time, highlight and select SPO2 on the home screen and select AVERAGING TIME.

The averaging time of 8 seconds is recommended for most patients. For patients with rapidly changing SpO2 values, the 4-second time is recommended. The 12 and 16 second time periods are used when artifact is affecting the performance of the pulse oximeter.

Pulse Oximeter Sensors

Both LNOP® and LNCS sensors from Masimo can be used with the LIFEPAK 12 defibrillator/monitor. Table 3-5 lists some of the Masimo sensors and extension cables that can be used with the LIFEPAK 12 defibrillator/monitor. Carefully read the directions for use provided with these sensors for complete description, instructions, warnings, cautions, and specifications. To order sensors and extension cables, contact your local Physio-Control representative.

Table 3-5 Sensors and Extension Cables for Masimo Oximeters

Description and Model Numbers	Patient Size
LNOP® Adt, 20/box, Physio-Control	Single-use sensor for patient >30 kg (66 lbs)
LNOP Pdt, 20/box, Physio-Control	Single-use sensor for patient >10 kg (22 lbs) <50 kg (110 lbs)
LNOP Neo, 20/box, Physio-Control	Single-use sensor for neonates <10 kg (22 lbs)
LNOP NeoPt, 20/box, Physio-Control	Single-use sensor for neonates <1 kg (2.2 lbs)
LNOP DCI, 1/box, Physio-Control	Reusable sensor for adults
LNOP DCIP, 1/box, Physio-Control	Reusable sensor for pediatrics
PC04, 1/box, Physio-Control	121.92 cm (4') reusable connector cable
PC08, 1/box, Physio-Control	243.84 cm (8') reusable connector cable
PC12, 1/box, Physio-Control	365.76 cm (12') reusable connector cable

Nellcor SpO2 Monitoring Procedure

Power to the pulse oximeter is controlled by the defibrillator. When the defibrillator is turned on, the oximeter powers up and performs a self-test and self-calibration that require up to 17 seconds. The oximeter also performs a 3-second self-calibration approximately every 15 minutes. When the defibrillator is turned off, the oximeter also turns off.

To conserve battery power, the pulse oximeter goes into “sleep mode” when not in use. Sleep mode is activated within 10 seconds of disconnecting the sensor. The oximeter will return to normal mode after detecting a sensor or a patient signal. The oximeter performs the self-test when it returns from sleep mode to active mode. During sleep mode, the screen does not display SpO2 information.

The pulse oximeter measures SpO2 levels between 50% and 100%. When SpO2 levels are between 70% and 100%, oximeter measurements are accurate from $\pm 2.0\%$ to $\pm 3.5\%$, depending on the sensor used.

- 1 Connect the SpO2 cable to the monitor.
- 2 Attach the sensor to the SpO2 cable and the patient.
- 3 Press ON.
- 4 Observe the pulse bar for fluctuation. Amplitude of the pulse bar indicates relative signal strength. Pulse tone pitch indicates the relative saturation level.
- 5 Adjust the volume or invoke C-LOCK as needed.

The SpO2 plethysmographic waveform can be displayed on waveform Channel 2 or 3. To display the waveform, select the desired waveform channel, and then select SPO2 from the waveform menu. The default gain is 2X. Gains of 1X and 4X can also be selected.

Pulse Oximeter Sensors

Table 3-6 lists the Nellcor sensors and extension cables to be used with the LIFEPAK 12 defibrillator/monitor. Carefully read the directions for use provided with these sensors for complete description, instructions, warnings, cautions, and specifications. To order sensors and extension cables, call Nellcor. In the USA call 1.800.635.5267. Outside the USA contact your local Nellcor representative.

Table 3-6 Sensors and Extension Cables for Nellcor Oximeters

Description and Model Numbers	Patient Size
Adhesive Sensors	
Oxisensor® II oxygen transducers	
D-25/D25L Adult Digital	>30 kg (66 lbs)
N-25 Neonatal/Adult	less than 3 kg (7 lbs) or greater than 40 kg (88 lbs)
I-20 Infant Digital	3 to 20 kg (7 to 44 lbs)
D-20 Pediatric Digital	10 to 50 kg (22 to 110 lbs)
R-15 Adult Nasal	>50 kg (110 lbs)
Oxiband® oxygen transducers	
OxiCliq®-A Adult	>30 kg (66 lbs)
OxiCliq®-N Neonatal/Adult	less than 3 kg (7 lbs) or greater than 40 kg (88 lbs)
OxiCliq®-I Infant	3 to 20 kg (7 to 44 lbs)
OxiCliq®-P Pediatric	10 to 50 kg (22 to 110 lbs)
Reusable Sensors	
Durasensor® DS-100A Adult	>40 kg (88 lbs)
Oxiband® OXI-A/N Adult/Neonatal	less than 3 kg (7 lbs) or greater than 40 kg (88 lbs)
Oxiband OXI-P/I Pediatric/Infant	3 to 40 kg (7 to 88 lbs)
RS-10 Adult	>40 kg (88 lbs)
Dura-Y® D-YS Multisite	>1 kg (2.2 lbs)
D-YSE Ear Clip	>30 kg (66 lbs)
PediCheck™ D-YSPD Pediatric	3 to 40 kg (7 to 88 lbs)
Extension Cables	
Nellcor EC-4 cable – 121.92 cm (4 feet)	
Nellcor EC-8 cable – 243.84 cm (8 feet)	

These sensors are available for the sensor recycling program. For more information on enrolling in the program, contact your local Nellcor representative. This program is currently available in the USA only.

SpO2 Volume

To adjust the pulse tone volume, highlight and select SpO2 on the Home Screen.

The following overlay appears:

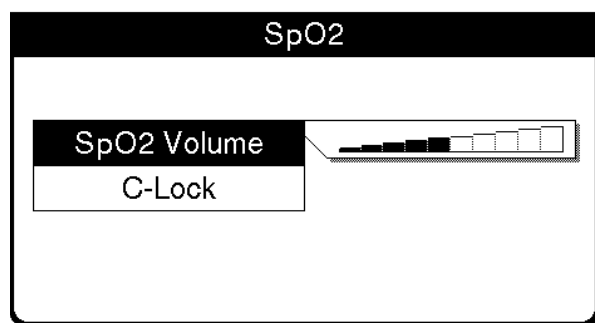

- 1 Highlight and select SPO2 VOLUME.
- 2 Rotate the SELECTOR to the desired volume.
- 3 Press the SELECTOR to set the volume.

C-LOCK

C-LOCK is a patented Nellcor function.

When C-LOCK is active, the saturation measurements are synchronized to each detected QRS to reduce the effects of any artifact on the SpO₂ measurements. If there is no ECG signal, C-LOCK will not be active. With C-LOCK on during Paddles lead monitoring, the pulse bar fluctuation and pulse tone may appear erratic. If this occurs, turn off C-LOCK.

With C-LOCK on during Noninvasive pacing, the pulse bar fluctuation and SpO₂ value may appear erratic. This could be due to the refractory period of the pacemaker. If this occurs, turn off C-LOCK.

To invoke the C-LOCK function, highlight and select SPO₂ on the Home Screen.

The following overlay appears:

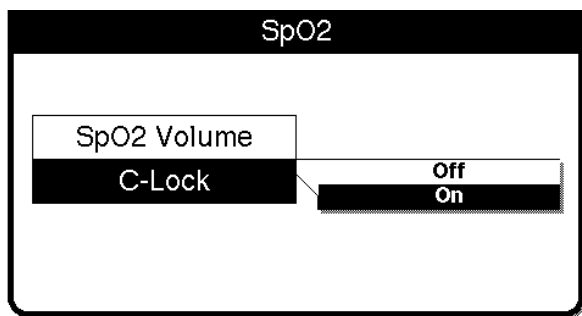

- 1 Highlight and select C-LOCK.
- 2 Select ON.
To deselect C-LOCK, repeat Step 1 and select OFF.

Cleaning

To clean a reusable Masimo sensor, remove it from the patient and disconnect it from the connector cable. You may then clean the sensor by wiping it with a 70% isopropyl alcohol pad. Allow the sensor to dry before placing it on a patient. Do not soak or immerse the sensor in any liquid solution. Do not attempt to sterilize.

Clean the connector cable by wiping it with a 70% isopropyl alcohol pad and allow it to dry. Do not soak or immerse the cable in any liquid solution. Do not attempt to sterilize.

Troubleshooting Tips for SpO₂

Table 3-7 Troubleshooting Tips for SpO₂

Observation	Possible Cause	Corrective Action
1 The monitor measures a pulse, but there is no oxygen saturation or pulse rate.	Excessive patient motion.	<ul style="list-style-type: none"> Keep patient still. Check that sensor is secure. Relocate sensor. Replace sensor.
	Patient perfusion may be too low.	<ul style="list-style-type: none"> Check patient. Increase sensitivity (Masimo only).
2 SpO ₂ or pulse rate changes rapidly, pulse amplitude is erratic.	Excessive patient motion.	<ul style="list-style-type: none"> Keep patient still. Check that sensor is secure. Relocate sensor. Replace sensor. Increase sensitivity (Masimo only)
	An electrosurgical unit (ESU) may be interfering with performance.	<ul style="list-style-type: none"> Move the monitor as far as possible from the ESU. Plug the ESU and monitor into different circuits. Move the ESU ground pad as close to the surgical site as possible. Sensor may be damp, replace it. Remove sensor extension cable and connect the sensor directly.
	Refractory period of the external pacemaker inhibits sensing of the ECG.	<ul style="list-style-type: none"> Turn off C-LOCK (Nellcor only).
3 No SpO ₂ value is displayed.	Oximeter may be performing self-calibration or self-test.	<ul style="list-style-type: none"> Wait for completion.
4 SPO ₂ : NO SENSOR DETECTED message appears.	Sensor not connected to patient or cable disconnects from device.	<ul style="list-style-type: none"> Check that sensor and cable are connected properly. Check that appropriate sensor is in use.
5 SPO ₂ : SENSOR OFF message appears (Nellcor only).	Sensor is disconnected from patient.	<ul style="list-style-type: none"> Re-attach sensor. Check that sensor is secure.
	Patient has a weak pulse or low blood pressure.	<ul style="list-style-type: none"> Test sensor on someone else. Check if patient perfusion is adequate for sensor location. Check if sensor is secure and not too tight. Check that sensor is not on extremity with blood pressure cuff or intravascular line. Change sensor location.
	Excessive ambient light.	<ul style="list-style-type: none"> Remove or block light source if possible. Cover sensor with opaque material, if necessary.
6 XXX appears in place of SPO ₂ reading.	SPO ₂ module failed. Internal cable failed.	<ul style="list-style-type: none"> Contact qualified service personnel.

Monitoring

Table 3-7 Troubleshooting Tips for SpO2 (Continued)

Observation	Possible Cause	Corrective Action
7 SPO2: CHECK SENSOR message appears.	Sensor is disconnected from patient or cable.	<ul style="list-style-type: none"> • Attach the sensor. • Check that sensor is secure.
	Excessive ambient light.	<ul style="list-style-type: none"> • Remove or block light source if possible. • Cover sensor with opaque material, if necessary.
	Patient has a weak pulse or low blood pressure.	<ul style="list-style-type: none"> • Test sensor on someone else. • Check if patient perfusion is adequate for sensor location. • Check if sensor is secure and not too tight. • Check that sensor is not on extremity with blood pressure cuff or intravascular line. • Change sensor location.
8 SPO2: UNKNOWN SENSOR message appears.	A sensor is connected to a device that is not a Physio-Control-approved sensor.	<ul style="list-style-type: none"> • Check that the sensor is an approved Physio-Control sensor. • An Adapter Cable (MNC-1) is available that allows a Nellcor sensor to be used with a Masimo-equipped LIFEPAK 12 defibrillator/monitor.
9 SPO2: SEARCHING FOR PULSE message appears.	A sensor is connected to the patient and is searching for a pulse.	<ul style="list-style-type: none"> • Wait for completion.
10 SPO2: LOW PERFUSION message appears.	Patient has a weak pulse.	<ul style="list-style-type: none"> • Change sensor location.

MONITORING NONINVASIVE BLOOD PRESSURE (NIBP)

The following paragraphs describe:

- NIBP Monitoring Warnings
- When to Use NIBP
- How NIBP Works
- NIBP Monitoring Considerations
- Cuff Selection
- NIBP Monitoring Procedures
- Changing the Initial Inflation Pressure
- Manual Single-Measurement Procedure
- Timer-Controlled Measurement Procedure
- Cleaning and Maintenance
- Troubleshooting Tips for NIBP Monitoring

NIBP Monitoring Warnings

WARNINGS!

Possible loss of intravenous access and inaccurate infusion rate.

Do not apply the blood pressure cuff on an extremity used for an intravenous infusion. Patency of the intravenous infusion may be affected by blood pressure measurement due to the occlusion of blood flow.

WARNINGS!**Possible inaccurate blood pressure readings.**

Do not operate the NIBP monitor unless it has been properly calibrated. A calibration and pneumatic check are recommended a minimum of once every year.

Possible inaccurate blood pressure readings.

Do not alter the NIBP monitor's pneumatic tubing. Altering NIBP tubing may cause improper performance and may void the warranty. Avoid compression or restriction of pressure tubes.

Possible inaccurate blood pressure readings.

If the monitor fails to respond as described in this section, do not use it until the device has been inspected by qualified service personnel.

Possible inaccurate blood pressure readings.

Using NIBP accessories not approved by Physio-Control may cause the device to perform improperly. Use only the accessories specified in these Operating Instructions.

Possible inaccurate oxygen saturation readings.

Do not perform measurement on an extremity used for oxygen saturation monitoring. Oxygen saturation measurement is affected by blood pressure measurement due to the occlusion of blood flow.

CAUTION!**Equipment damage.**

Do not inflate a cuff unless it is placed on an extremity.

When to Use NIBP

The NIBP monitor measures the blood pressure of the adult or pediatric patient in a noninvasive manner. Noninvasive blood pressure monitoring may be useful during ECG monitoring or for post-defibrillation recovery analysis. Because blood pressure can change in a short time, data should be refreshed regularly during intensive vital-signs monitoring. NIBP is a tool to be used in addition to patient assessment. Care should be taken to assess the patient at all times and not to rely solely on the NIBP monitor.

How NIBP Works

The NIBP monitor uses the oscillometric measurement technique. The oscillometric technique does not use Korotkoff sounds to determine blood pressure; rather, it monitors the changes in pressure pulses caused by the flow of blood through the artery. The NIBP monitor inflates the cuff around the patient's arm to a value that occludes the artery, then deflates the cuff in steps. When blood starts to flow through the artery, the increasing blood flow causes the amplitude of the pressure pulses in the cuff to increase. As the NIBP monitor steps the pressure down, the pulses reach a peak amplitude and then start to decrease. The rising and falling amplitude values form a curve that is analyzed to yield systolic pressure, diastolic pressure, and mean arterial pressure (MAP).

The NIBP monitor measures the pulse rate by tracking the number of pulses over time.

The NIBP monitor uses artifact rejection techniques to provide accurate results under most operating conditions.

NIBP Monitoring Considerations

As with any noninvasive oscillometric blood pressure monitor, there are clinical conditions that can affect the accuracy of the measurements obtained:

- The patient's physiological condition. For example, shock may result in a blood pressure waveform with a low amplitude and make it difficult for the monitor to accurately determine the systolic and diastolic pressures.
- The position of the patient.
- Motion may prolong the measurement process since motion artifacts have to be rejected in the data stream. Motion that affects measurement can include patient movement, patient seizure, bumping the cuff, and flexing the extremity under the cuff.
- The presence of other medical devices. The NIBP monitor does not operate effectively if the patient is connected to a heart/lung machine.
- When a patient is experiencing arrhythmias, pulse rate accuracy may be affected or the time needed to complete an NIBP measurement may be extended. The device automatically deflates if a blood pressure measurement cannot be obtained in 120 seconds.
- Blood pressure and pulse can fluctuate greatly between measurements; the monitor cannot alert the operator of changes in vital signs occurring between measurement cycles.
- There may be some difference between readings taken manually and readings from the NIBP monitor due to the differing sensitivity of the two methods. The NIBP monitor meets the ANSI/SP10 AAMI standard requiring a mean difference of ± 5 mmHg, with a standard deviation no greater than 8 mmHg, compared to auscultatory readings.
- When using the NIBP monitor during defibrillation, the NIBP monitor is not available when the defibrillator is being charged. Upon shock, the monitor resets and dashes (— —) appear in place of pressure readings. After defibrillation, you can resume blood pressure measurement according to NIBP Monitoring Procedures in this section.
- If the blood pressure cuff fails to deflate for any reason or causes undue discomfort to the patient, remove the cuff from the arm or disconnect the tubing from the defibrillator.

Cuff Selection

Using properly designed and sized cuffs is essential for the accurate measurement of blood pressure. The cuff must fit snugly around the extremity to occlude the artery. See the LIFEPAK 12 Accessory Catalog or consult your Physio-Control sales representative for information about the blood pressure cuffs to be used with the LIFEPAK 12 defibrillator/monitor.

NIBP Monitoring Procedures

The NIBP monitor inflates an occluding cuff and determines systolic and diastolic pressures, mean arterial pressure (MAP), and pulse rate. Pressure measurements are reported in mmHg or kPa and pulse rate in beats per minute (bpm). The measurement typically takes 40 seconds to complete. In no case does the cuff remain pressurized for more than 120 seconds.

Both single-measurement and specified-interval (timer-controlled) methods of blood pressure reading are available.

The NIBP monitor draws power from the defibrillator. When the defibrillator is turned on, the NIBP monitor conducts a self-test that takes approximately 3 seconds.

Changing the Initial Inflation Pressure

The initial cuff pressure should be set approximately 30 mmHg higher than the patient's systolic pressure. The factory default initial inflation pressure for the first measurement is 160 mmHg. For subsequent measurements, the monitor inflates approximately 30 mmHg higher than the previously determined systolic pressure. Initial inflation settings are 100, 120, 140, 160, or 180 mmHg. Caution should be taken not to lower the initial pressure below the patient's systolic measurement. This may cause the cuff to reinflate and cause patient discomfort.

To select an initial pressure:

- 1 Highlight and select NIBP on the Home Screen. The following overlay appears.

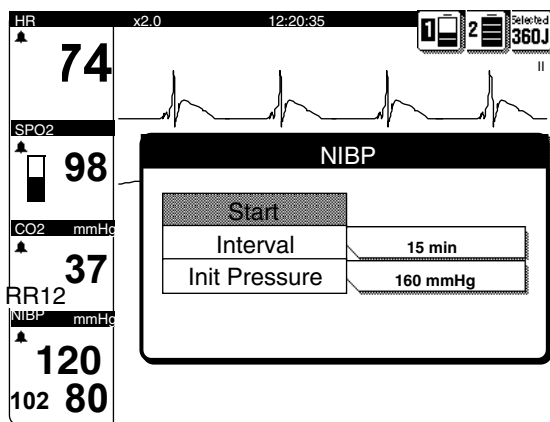

Figure 3-12 NIBP Overlay

- 2 Choose an initial pressure by selecting INIT PRESSURE from the NIBP overlay on the display.

Note: Measurement data is recorded in the LIFEPAK 12 defibrillator/monitor vital signs log. See Section 6, Data Management, for information on the vital signs log and its use.

Manual Single-Measurement Procedure

The NIBP measurement typically takes 40 seconds to complete. If the measurement is not completed within 120 seconds, the cuff automatically deflates.

- 1 Press ON. Adjust contrast if necessary.
- 2 Select the appropriately sized cuff.
- 3 Properly align the cuff artery markings, if present, and apply snugly to the extremity.
- 4 Connect the tubing to the cuff and to the NIBP connector on the monitor.
- 5 Change the initial inflation pressure if necessary.
- 6 Position the extremity in a relaxed and supported position at approximately the same level as the patient's heart. Inform the patient that the cuff will inflate and cause a "big squeeze" around the arm and that his/her fingers may tingle.
- 7 Press NIBP to start the measurement, and check that the patient's arm is not moving. A "beep" indicates the measurement is complete, and the display shows systolic, diastolic, and mean arterial pressures.

Note: During a measurement, press NIBP again if you wish to cancel the measurement and deflate the cuff.

Note: Pulse rate is displayed only when ECG or SpO2 is not active.

Error or alarm messages appear in the status area on the bottom line of the display.

Timer-Controlled Measurement Procedure

The monitor performs recurring measurements at a set interval when the timer is set. Choices are OFF (factory default), 2, 3, 5, 10, 15, 30, and 60 minutes.

- 1 Press ON. Adjust contrast if necessary.
- 2 Select the appropriately sized cuff.
- 3 Properly align the cuff artery markings, if present, and apply snugly to the extremity.
- 4 Connect the tubing to the cuff and to the NIBP connector on the monitor.
- 5 To select an interval, highlight and select NIBP on the Home Screen. Refer to Figure 3-12.

Monitoring

- 6 Choose a time interval by selecting `INTERVAL` from the NIBP overlay on the display.
- 7 Proceed with NIBP measurement as described previously in Manual Single-Measurement Procedure.

Note: When using timer-controlled measurement, the interval is counted from the start of the measurement to the start of the next measurement. To take a manual measurement between timer-controlled measurements, press `NIBP`. The next interval is counted from the beginning of the manual measurement.

Note: During measurement, press `NIBP` if you wish to interrupt the measurement and deflate the cuff.

Note: If, at any time, the cuff pressure exceeds 300 mmHg or there is a system failure of the NIBP module, timer-controlled NIBP will be terminated. To reactivate, follow the Timer-Controlled Measurement Procedure above.

Cleaning and Maintenance

Disconnect the cuff and pneumatic tubing from the defibrillator/monitor before cleaning. Use a clean, soft cloth dampened with a germicidal solution to clean tubing. To clean a reusable blood pressure cuff, follow the instructions packaged with that particular type of cuff.

Inspect the pneumatic tubing for cracks or kinks. If any damage is noted, replace the tubing.

Calibration must be verified at least annually by qualified service personnel. Leakage test must be performed at least annually by a qualified service person.

Troubleshooting Tips for NIBP Monitoring

Table 3-8 Troubleshooting Tips for NIBP Monitoring

Observation	Possible Cause	Corrective Action
1 NIBP AIR LEAK message appears.	Cuff applied too loosely. Leak in cuff/monitor pneumatic system.	<ul style="list-style-type: none">• Check cuff for snug fit on patient.• Check that the cuff/monitor connection is secure.• Check cuff for leaks. Do not use a cuff that exhibits a leak.
2 NIBP FLOW ERROR message appears.	The pneumatic system is not maintaining stable cuff pressure.	<ul style="list-style-type: none">• Deflate or remove cuff.• Check external tubing for leaks.• Perform pneumatic check.• Replace cuff.
3 NIBP FAILED message appears.	The monitor cannot establish zero-pressure reference.	<ul style="list-style-type: none">• Check tubing for kink or blockage.• Perform pneumatic check.• If this message persists, remove monitor from use and obtain service. Use another method to measure the patient's blood pressure.
4 NIBP INITIALIZING message appears.	NIBP is requested and unable to be successful due to a 30 second reset.	<ul style="list-style-type: none">• Wait until message disappears and request NIBP.
5 NIBP MOTION message appears.	The patient extremity moved too much for the monitor to accurately complete the measurement.	<ul style="list-style-type: none">• Have patient lie quietly with extremity relaxed and supported.• Check that patient's arm does not move during NIBP measurement.

Table 3-8 Troubleshooting Tips for NIBP Monitoring

Observation	Possible Cause	Corrective Action
6 NIBP OVERPRESSURE message appears.	Cuff pressure exceeded 290 mmHg.	<ul style="list-style-type: none"> • Deflate or remove cuff. • Avoid very rapid squeezing of the cuff. • If this message persists, remove it from use and obtain service.
7 NIBP TIME OUT message appears.	The monitor did not complete a measurement in 120 seconds.	<ul style="list-style-type: none"> • Check cuff for snug fit on patient. • Check that cuff artery markings are aligned with the artery. • Repeat measurement. • Try a higher initial pressure. • If this message persists, use another method to measure the patient's blood pressure.
8 NIBP WEAK PULSE message appears.	The monitor did not detect any pulses.	<ul style="list-style-type: none"> • Check pulses distal to the cuff. • Check cuff for snug fit on patient. • Check that cuff artery markings are aligned with the artery.
9 XXX appears in place of NIBP readings.	NIBP module failed. NIBP module failed to calibrate successfully.	<ul style="list-style-type: none"> • Contact qualified service personnel.
10 NIBP CHECK CUFF	The cuff is not connected to patient or device.	<ul style="list-style-type: none"> • Check cuff for snug fit on patient. • Check that cuff artery markings are aligned with the artery. • Check cuff tubing connection to device.

MONITORING ETCO₂

The following paragraphs describe:

- EtCO₂ Monitoring Warnings
- When to use EtCO₂ Monitoring
- How Capnography Works
- EtCO₂ Monitoring Waveform Analysis
- EtCO₂ Monitoring Procedure
- CO₂ Scale Options
- CO₂ Alarms
- Cleaning and Maintenance
- Troubleshooting Tips for EtCO₂ Monitoring

EtCO₂ Monitoring Warnings

WARNINGS!

Fire hazard.

Before use, carefully read these Operating Instructions, the FilterLine® tubing directions for use, and precautionary information.

Fire hazard.

Flammable anesthetics become mixed with the patient's air that is sampled by the capnometer. When using the EtCO₂ monitor in the presence of flammable gases, such as nitrous oxide or certain other anesthetics, connect the EtCO₂ gas port to a scavenger system.

Fire hazard.

The FilterLine tubing may ignite in the presence of O₂ when directly exposed to laser, electrosurgical devices, or high heat. Use with caution to prevent flammability of the FilterLine tubing.

Possible strangulation.

Carefully route the patient tubing (FilterLine) to reduce the possibility of patient entanglement or strangulation.

Possible inaccurate patient assessment.

The LIFEPAK 12 EtCO₂ monitor is intended only as an adjunct in patient assessment and is not to be used as a diagnostic apnea monitor. An apnea message appears if a valid breath has not been detected for 30 seconds and indicates the time elapsed since the last valid breath. It must be used in conjunction with clinical signs and symptoms.

Infection hazard.

Do not reuse, sterilize, or clean Microstream™ CO₂ accessories as they are designed for single-patient one-time use.

Possible inaccurate CO₂ readings.

Using other manufacturers' CO₂ accessories may cause the device to perform improperly. Use only the accessories specified in these Operating Instructions.

When to Use EtCO₂ Monitoring

The EtCO₂ monitor is a capnometric and capnographic device that measures the amount of CO₂ during each breath, displays the CO₂ waveform, and reports the amount present at the end of exhalation as an indication of breathing efficacy (EtCO₂). EtCO₂ monitoring is used in acute cardiopulmonary care and to detect trends in the level of expired CO₂, for example, to determine if adequate compressions are being performed during CPR or to rapidly detect whether an endotracheal tube (ETT) has been placed successfully. The EtCO₂ monitor is intended for use on adult and pediatric patients.

How Capnography Works

An EtCO₂ sensor continuously monitors carbon dioxide (CO₂) that is exhaled by the patient. The sensor, employing Microstream™ non-dispersive infrared (IR) spectroscopy, measures the concentration of CO₂ molecules that absorb infrared light. Because the absorption of IR light is proportional to the concentration of CO₂ molecules, the concentration of CO₂ can be determined by comparing its absorption to that of a known standard.

You can configure the LIFEPAK 12 defibrillator/monitor to use the capnography Body Temperature Pressure Saturated (BTPS) conversion method. This option corrects for the difference in temperature and moisture between the sampling site and alveoli. The correction formula is $0.97 \times$ the measured EtCO₂ value.

The Microstream CO₂ FilterLine™ delivers a sample of the exhaled gases directly from the patient into the LIFEPAK 12 for CO₂ measurement. The low sampling flow rate (50 ml/min) reduces liquid and

secretion accumulation and prevents obstruction of the sample pathway in humid environments. Moisture and patient secretions are extracted from the sample, while the shape of the CO₂ waveform is maintained.

Once inside the Microstream CO₂ sensor, the gas sample is temporarily captured in a micro sample cell (15 microliters). This extremely small volume is quickly flushed, allowing for fast rise time and accurate CO₂ readings, even at high respiration rates.

The Micro Beam IR source illuminates the sample cell and the reference cell. This proprietary IR light source generates only the specific wavelengths characteristic of the CO₂ absorption spectrum. Therefore, no compensations are required when different concentrations of N₂O, O₂, anesthetic agents, and water vapor are present in the exhaled breath. The radiation that passes throughout the sample cell and the radiation that passes through the reference cell are measured by the IR detectors. The EtCO₂ monitor's microcomputer calculates the CO₂ concentration by comparing the signals from the detector (sample) and reference channels.

The CO₂ module does not recognize a breath when the EtCO₂ value is less than 8 mmHg (1.0 kPa and 1.0%). If this condition continues, the APNEA alarm (refer to page 3-34) will sound because the device has not detected a breath for greater than 30 seconds. However, the waveform remains valid and can be used to determine the EtCO₂ measurement and the presence, if any, of respiration.

EtCO₂ Monitoring Waveform Analysis

Most of the information concerning the patient's expired CO₂ is acquired by examination and interpretation of the waveform. This should be done in a systematic fashion to avoid errors and to determine whether EtCO₂ monitoring will be a useful tool for a patient in a particular situation.

CO₂ Detection

When CO₂ is not detected, three factors must be quickly evaluated for possible causes:

- Loss of airway function
 - improper placement of the ETT (e.g. esophageal intubation) or other segments of the breathing circuit
 - apnea
- Loss of circulatory function
 - massive pulmonary embolism
 - cardiac arrest
 - exsanguination
- Equipment malfunction
 - ETT extubation
 - ETT obstruction

The Phases of the Waveform

Figure 3-13 shows a normal capnograph waveform display. There are 4 phases of the waveform that require analysis. The flat I–II baseline segment (Respiratory Baseline) represents exhalation of CO₂-free gas that is contained in dead space from the conduction airways. This value normally is zero. The II–III segment (Expiratory Upstroke), a sharp rise, represents exhalation of a mixture of dead space gases and alveolar gases from acini with the shortest transit times. Phase III–IV (Expiratory Plateau) represents the alveolar plateau, characterized by exhalation of mostly alveolar gas. Point IV is the end-tidal (EtCO₂) value that is recorded and displayed by the monitor. Phase IV–V (Inspiratory Downstroke), a sharp fall, reflects the inhalation of gases that are CO₂-free. Alterations of the normal capnograph or EtCO₂ values are the result of changes in metabolism, circulation, ventilation, or equipment function.

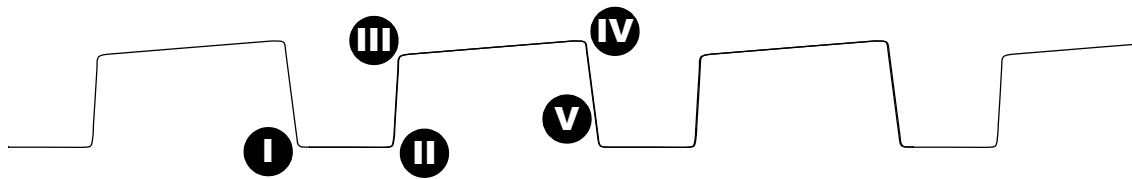

Figure 3-13 Phases of the Respiratory Waveform

Respiratory Baseline. Elevation of the waveform baseline (I–II segment) usually represents rebreathing CO₂. This elevation usually is accompanied by gradual increases in the EtCO₂ value. Rebreathing CO₂ is common in circumstances of artificially produced increased dead space and hypoventilation. Precipitous rises in both baseline and EtCO₂ values usually indicate contamination of the sensor.

Expiratory Upstroke. In the normal waveform, the rising phase (II–III segment) is usually steep. When this segment becomes less steep, CO₂ delivery is delayed from the lungs to the sampling site. The causes of this can be physiologic or mechanical and include bronchospasm, obstruction of the upper airway, or obstruction (kinking) of an ETT.

Note: In newer devices, the shape of the waveform in the expiratory upstroke may be slightly different. Regardless, there is no change in the EtCO₂ or respiratory rate value.

Expiratory Plateau. The plateau of the waveform, representing the remainder of expiration (III–IV segment), should be nearly horizontal. The end of the plateau represents the EtCO₂ value. Upward slanting of the expiratory plateau occurs when there is uneven emptying of the alveoli. Similar to the diminished slope of the Expiratory Upstroke, this pattern can occur in asthma, chronic obstructive pulmonary disease (COPD), partial upper-airway obstruction, or partial mechanical obstruction, such as a partially kinked ETT.

Inspiratory Downstroke. The fall to baseline (IV–V segment) is a nearly vertical drop. This slope can be prolonged and blend with the expiratory plateau in cases of leakage in the exhale portion of the breathing circuit. The peak EtCO₂ value (IV) is often not reached. Relying on the numeric end-tidal value without observing the breathing waveform may obscure the presence of a leak.

EtCO₂ Monitoring Procedure

When activated, the EtCO₂ monitor draws power from the defibrillator. The LIFEPAK 12 Biphasic defibrillator/monitor activates the EtCO₂ monitor by sensing the attachment of the CO₂ tubing. Initialization, self-test, and warm up of the EtCO₂ monitor may take up to two-and-one-half minutes.

CAUTION!

Possible equipment damage.

Failure to keep the CO₂ tubing connector door closed when not in use may cause water or particulate contamination of the CO₂ sensor. This may cause the CO₂ module to malfunction.

- 1 Open the CO₂ tubing connector door and connect the appropriate Microstream CO₂ FilterLine tubing by turning the tubing clockwise.

Note: Connect the tubing to the LIFEPAK 12 Biphasic defibrillator/monitor first; then connect it to the patient's airway.

- 2 Press ON. Adjust contrast if necessary.
- 3 Verify that the EtCO₂ monitor display is on.
- 4 Connect the appropriate Microstream CO₂ FilterLine to the patient.

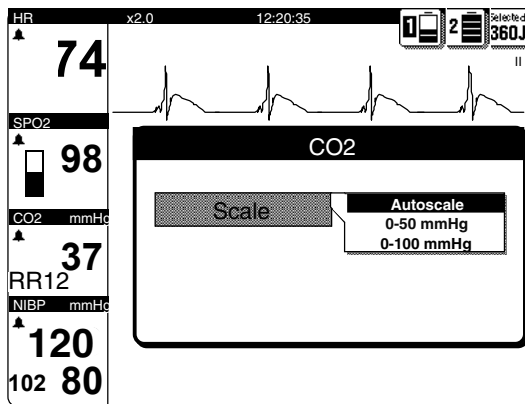

Figure 3-14 EtCO2 Overlay

- 5 Display CO2 waveform in Channel 2 or 3.
- 6 Adjust scale, if necessary, as described in the next paragraph.

Note: CO2 monitoring is initiated when the filterline is connected to the device. The EtCO2 monitor performs the autozero routine as part of the initialization self-test.

Note: During rapid altitude changes (exceeding 500 ft/min) or ambient pressure change of 12.4 mmHg/min maximum, the CO2 module will detect a pressure change in the filterline and attempt to purge the tubing. To clear the CO2 FILTERLINE PURGING or CO2 FILTERLINE BLOCKAGE messages, remove the filterline and reconnect it to the LIFEPAK 12 defibrillator/monitor.

CO2 Scale Options

There are three options available for the display scale. To change the CO2 scale, select CO2 and choose the desired scale from the scale overlay.

- Autoscale (default). Overselects appropriate scale based on measured EtCO2 value.
- 0–50 mmHg (0–7 kPa or 0–7 Vol%).
- 0–100 mmHg (0–14 kPa or 0–14 Vol%).

CO2 Alarms

The EtCO2 monitor provides:

- EtCO2 high and EtCO2 low alarms.
- FiCO2 (inspired CO2) alarm.
- APNEA alarm. This alarm is on whenever EtCO2 monitoring is in use and the device detects a valid breath. It is not controlled by the LIFEPAK 12 defibrillator/monitor Quick Set feature. The APNEA alarm appears when no valid breath has been detected for 30 seconds. The message ALARM APNEA appears in the status region on the display along with the time since the last detected breath.

Cleaning and Maintenance

Do not clean and reuse tubing. Accessories for CO2 monitoring are disposable and intended for one-time use. Dispose of the contaminated waste according to local protocols.

Calibration should be performed at least annually by qualified service personnel.

Troubleshooting Tips for EtCO₂ Monitoring

Table 3-9 Troubleshooting Tips for EtCO₂ Monitoring

Observation	Possible Cause	Corrective Action
1 ALARM APNEA message appears.	No breath has been detected for 30 seconds since last valid breath.	<ul style="list-style-type: none"> First check the patient, then ventilation equipment (if used) for leaks or disconnected tubing.
	FilterLine connection to device is loose.	<ul style="list-style-type: none"> Twist FilterLine connector to secure to device.
2 CO ₂ FILTERLINE OFF message appears.	FilterLine, or any other CO ₂ accessories disconnected or not securely connected to the LIFEPAK 12 EtCO ₂ connector.	<ul style="list-style-type: none"> Connect FilterLine tubing, or any other CO₂ accessories, to input connector or tighten connection.
3 CO ₂ FILTERLINE BLOCKAGE message appears.	FilterLine is kinked or clogged. The message appears after 30 seconds of unsuccessful purging.	<ul style="list-style-type: none"> Disconnect, then reconnect the FilterLine tubing. Check the FilterLine tubing and if necessary, unkink or replace.
	Airway Adapter clogged.	<ul style="list-style-type: none"> Check the Airway Adapter and if necessary, replace it.
4 CO ₂ FILTERLINE PURGING message appears.	FilterLine tube kinked or clogged with water, or rapid altitude change occurred.	<ul style="list-style-type: none"> Check the FilterLine tubing and if necessary, untwist and reconnect it.
5 EtCO ₂ values are erratic.	A leak in the tubing.	<ul style="list-style-type: none"> Check for connection leaks and line leaks to patient and correct if necessary.
	A mechanically ventilated patient breathes spontaneously.	<ul style="list-style-type: none"> No action required.
6 EtCO ₂ values are consistently higher or lower than expected.	Physiological cause.	<ul style="list-style-type: none"> Check patient.
	Ventilator malfunction.	<ul style="list-style-type: none"> Check ventilator and patient.
	Improper calibration.	<ul style="list-style-type: none"> Contact qualified service personnel.
7 XXX appears in place of EtCO ₂ value.	CO ₂ module not calibrated successfully.	<ul style="list-style-type: none"> Contact qualified service personnel.
	CO ₂ module failed.	<ul style="list-style-type: none"> Contact qualified service personnel.

MONITORING INVASIVE PRESSURE (IP)

The following paragraphs describe:

- IP Monitoring Warnings
- When to Use IP
- How IP Works
- IP Monitoring Considerations
- IP Monitoring Procedure
- Cleaning and Maintenance
- Troubleshooting Tips for IP Monitoring

IP Monitoring Warnings

WARNINGS!

Possible inaccurate pressure readings, air embolism, blood loss or loss of sterility.

Before use, carefully read these Operating Instructions, the transducer and infusion set instructions for use and precautionary information.

Possible lethal arrhythmia.

Ventricular fibrillation may be induced if the isoelectric barrier of the transducer is disrupted. The isoelectric barrier within the transducer may be disrupted if the transducer body is damaged. Do not use a transducer that is visibly damaged or leaking fluid.

Inaccurate pressure readings.

Pressure readings should correlate with the patient's clinical presentation. If readings do not, verify that the zeroing stopcock is positioned at the patient's zero reference, rezero the transducer, and/or check the transducer with a known or calibrated pressure. Manually check cuff blood pressure.

Inaccurate pressure readings.

Changing the patient's position changes the zero reference level. Relevel the transducer's zeroing stopcock anytime the patient position is changed.

Increased intracranial pressure.

Do not use a continuous flush device with transducers used for intracranial monitoring.

When to Use IP

The invasive pressure monitor can be used for measuring arterial, venous, intracranial pressures, or other physiological pressures using a compatible transducer. Two channels are available for invasive pressure monitoring, with default labels P1 and P2 and the following user-selectable labels.

Label	Description
ART	Arterial Pressure
PA	Pulmonary Artery Pressure
CVP	Central Venous Pressure
ICP	Intracranial Pressure
LAP	Left Atrial Pressure

When ICP, LAP, or CVP labels are used, the IP monitoring area displays mean pressure in large type. Systolic and diastolic pressures are not displayed.

Because pressures can change in a short time, data should be checked regularly during vital-signs monitoring. Invasive pressure monitoring is a tool to be used in addition to patient assessment. Care should be taken to assess the patient at all times and not to rely solely on the IP monitor.

How IP Works

Invasive pressure monitoring involves the conversion of fluid pressure into an electrical signal. The conversion is accomplished with a pressure transducer. The transducer is connected to a patient's indwelling pressure catheter using a special assembly of tubing, stopcocks, adapters, flush valves and fluids, commonly known as a flush system. The transducer translates the pressure wave into an electrical signal. A well-functioning flush system is essential for obtaining undistorted waveforms and accurate information.

IP monitoring is available on either Channel 2 or 3. The IP connector (6-pin type 3102A-14S-6S) is compatible with industry standard (AAMI-BP22) pressure transducers with $5\mu\text{V}/\text{V}/\text{mmHg}$ sensitivity. See the LIFEPAK 12 Accessory Catalog or consult your Physio-Control sales representative for information about invasive pressure transducers that are compatible with the LIFEPAK 12 defibrillator/monitor. If the use of other transducers is desired, the customer must be responsible for determining if the transducers comply with standards and are compatible with the monitor.

An invasive pressure cable is used to connect the transducer to the monitor.

The IP monitor can display pressures from -30 to 300 mmHg. After zeroing the transducer pressure, the monitor automatically selects one of the following scales based on the patient's measured pressure:

- -30 to 30 mmHg
- 0 to 60 mmHg
- 0 to 120 mmHg
- 0 to 150 mmHg
- 0 to 180 mmHg
- 0 to 300 mmHg

The user can also manually select one of these scales.

IP Monitoring Considerations

As with any invasive pressure monitor, there are clinical conditions that can affect the accuracy of the measurements obtained:

- The position of the patient. Pressures change if the patient is upright or horizontal.

IP Monitoring Procedure

Prepare a flush system according to local protocols. Position the transducer at the patient's phlebostatic axis (zero-reference level).

To avoid offset errors, a zero reference must be established before any meaningful pressure readings are obtained. This is done by opening the transducer stopcock to air so that atmospheric pressure becomes the reference.

The P1 or P2 connector and Channel 2 or 3 can be used for invasive pressure monitoring. P1 and Channel 2 are used in these instructions.

- 1 Press ON. Adjust contrast if necessary.
- 2 Prepare the transducer according to the operating instructions provided with the transducer and according to your local protocol.
- 3 Connect the IP adapter cable to the transducer and to the P1 connector on the monitor.
- 4 Use the default label P1 or select ART, PA, CVP, ICP, or LAP. To change the label, select the P1 parameter area. From the menu, select P1. Select a label from the list.
- 5 Select CHANNEL 2 from the main screen. From the Channel 2 menu, select WAVEFORM, and then select the label desired for the waveform.
- 6 Open the transducer's stopcock to air to zero the transducer. Select the P1 parameter area. Select zero from the menu. The message P1 ZEROED appears when zeroing is complete and the pressure values are displayed as zeros.

- 7 Close the stopcock to air. The patient's pressure waveform should be displayed. A scale is automatically selected to display the pressure. Confirm pressure amplitude correlates with digital readout.

Note: If you place a cap on an open port before closing it to air, an error message may appear. You will be required to zero the transducer again.

(Optional) You can change the scale or select **AUTOSCALE** anytime to readjust the waveform within the channel. To change the scale, select the P1 parameter area. From the menu, select **SCALE**, and then choose a scale from the list.

If pressure alarms are desired, limits should be set after a satisfactory waveform display has been obtained. For more information, refer to "Setting Alarms" on page 2-22.

Error or alarm messages appear in the status area on the bottom line of the display.

Cleaning and Maintenance

Disconnect the transducer and connector cable from the defibrillator/monitor before cleaning the device or cable. Use a clean, soft cloth dampened with a germicidal solution to clean the connector cable. Refer to Section 8, "Maintaining the Equipment" for instructions on cleaning the defibrillator/monitor.

Dispose of the transducer according to local protocols.

Troubleshooting Tips for IP Monitoring

The error messages in the table below use the text Px to represent any of the labels for invasive pressure, including P1, P2, and the user-selectable labels ART, PA, CVP, ICP, and LAP.

Table 3-10 Troubleshooting Tips for IP Monitoring

Observation	Possible Cause	Corrective Action
1 Invasive pressure display is blank.	No transducer is connected.	<ul style="list-style-type: none"> Connect the transducer to the cable, and the cable to the monitor.
2 No scale appears next to the waveform.	The zero reference has not been established.	<ul style="list-style-type: none"> Zero the transducer.
3 PX TRANSDUCER NOT DETECTED message appears.	Transducer disconnected.	<ul style="list-style-type: none"> Verify the connections of the transducer. Reconnect the transducer to the cable and the cable to the monitor.
	Transducer damaged and/or leaking	<ul style="list-style-type: none"> Replace transducer immediately.
4 PX NOT ZEROED message appears.	The zero reference has not been established.	<ul style="list-style-type: none"> Zero the transducer.
5 ZERO FAILED message appears.	An unsuccessful attempt has been made to set a zero reference value.	<ul style="list-style-type: none"> Make sure that the transducer is open to air and repeat the attempt to zero.
6 Dampened waveform.	Loose connection.	<ul style="list-style-type: none"> Check the entire system for leaks. Tighten all connections. Replace any defective stopcocks.
	Tubing too long or too compliant.	<ul style="list-style-type: none"> Use short, stiff tubing with a large diameter.
	Thrombus formation, air bubbles or blood left in catheter after blood draw.	<ul style="list-style-type: none"> Use syringe to draw back air or particles in catheter, then flush system.
	Kinked catheter, catheter tip against vessel wall, arterial spasm.	<ul style="list-style-type: none"> Reposition catheter. Anchor catheter to skin at insertion site.

Monitoring

Table 3-10 Troubleshooting Tips for IP Monitoring (Continued)

Observation	Possible Cause	Corrective Action
7 Resonating waveform.	Tubing too long.	<ul style="list-style-type: none"> Use short, stiff tubing with large diameter.
8 No waveform. No pressure reading.	Transducer closed to patient.	<ul style="list-style-type: none"> Check patient. Check stopcock positions and monitor setup.
9 Invasive BP lower than cuff BP.	Transducer level higher than the heart.	<ul style="list-style-type: none"> Reposition transducer to correct height.
	Loose connection.	<ul style="list-style-type: none"> Tighten all connections.
	Thrombus formation, air bubbles, or blood in catheter, kinking, or arteriospasm.	<ul style="list-style-type: none"> Use syringe to draw back air or particles in catheter, then flush system.
	Improper zero reference.	<ul style="list-style-type: none"> Open stopcock to air and rezero transducer.
	Defective transducer.	<ul style="list-style-type: none"> Replace transducer.
10 Invasive BP higher than cuff BP.	Transducer level lower than the heart.	<ul style="list-style-type: none"> Reposition transducer to correct height.
	Improper zero reference.	<ul style="list-style-type: none"> Rezero.
	Catheter whip artifact.	<ul style="list-style-type: none"> Change catheter tip position. Use mean pressure values (mean pressure less affected by extremes, therefore will reflect more accurate reading).
11 Inability to flush system.	Pressure bag leaking.	<ul style="list-style-type: none"> Keep positive pressure in flush bag at all times. Remove dressing to check for external kinking.
	Partially kinked or obstructed catheter.	<ul style="list-style-type: none"> Replace catheter if clotted.
12 Inability to zero system.	Stopcock not open to air or defective.	<ul style="list-style-type: none"> Check stopcock position. Replace any defective stopcocks.
	Defective transducer.	<ul style="list-style-type: none"> Replace transducer.
13 System has been zeroed but continues to indicate zero reference required.	Steps to zero system performed in wrong order.	<ul style="list-style-type: none"> Close stopcock to air before placing cap on port.
14 Catheter whip (fling) artifact Pulmonary Artery	Excessive catheter movement. Motion of the catheter tip within the vessel accelerates fluid movement in the catheter – causing artifact to be superimposed on the pressure wave, increasing readings by 10–20 mmHg.	<ul style="list-style-type: none"> Change catheter tip position. Use mean pressure values (mean pressure less affected by extremes, therefore will reflect more accurate reading).

Table 3-10 Troubleshooting Tips for IP Monitoring (Continued)

Observation	Possible Cause	Corrective Action
15 Permanent Pulmonary Wedge Pressure (PWP) tracing (wedge tracing persists after balloon deflation).	Catheter tip partially clotted.	<ul style="list-style-type: none"> Use syringe to aspirate, then flush.
	Catheter migrated distally in pulmonary artery.	<ul style="list-style-type: none"> Observe PA waveform before balloon inflation. Flattening of the waveform could indicate wedging with balloon deflated. Turn patient side to side in Trendelenburg position, or stimulate cough in attempt to dislodge catheter. Retract catheter with balloon deflated until proper position is obtained. Minimize chances of catheter advancement by firmly anchoring catheter at insertion site.
16 Failure to obtain PWP.	Malposition of catheter tip.	<ul style="list-style-type: none"> Reposition catheter.
	Leak in balloon. Ruptured balloon.	<ul style="list-style-type: none"> Replace catheter.
17 Progressive elevation of PWP.	Overinflation.	<ul style="list-style-type: none"> Inflate balloon in small increments while watching scope for confirmation of wedging. Use only enough air to wedge. Do not use more than the volume recommended by the manufacturer.
	Catheter migrated distally in pulmonary artery.	<ul style="list-style-type: none"> Reposition catheter.

MONITORING VITAL SIGNS (VS) AND ST CHANGES

The following paragraphs describe:

- VS and ST Monitoring Warning
- When to Use VS and ST Monitoring
- How VS and ST Monitoring Work
- VS and ST Monitoring Considerations
- VS and ST Monitoring Procedure

VS and ST Monitoring Warning

WARNING!

Inaccurate interpretation of patient status.

Vital sign and ST graphs are tools to be used in addition to patient assessment. Artifact and noise may produce spurious data. Ensure artifact-free monitoring as much as possible and assess the patient frequently to confirm the appropriateness of monitor data.

When to Use VS and ST Monitoring

Vital sign monitoring is indicated for use with any patient that requires continuous monitoring of vital signs over an extended period of time to identify changes in patient condition and to document patient response to therapy. ST trending is indicated for use with patients suspected of having acute ischemic events, such as unstable angina, and with patients following treatment for an acute ischemic event.

How VS and ST Monitoring Work

The Vital Sign and ST monitoring features of the LIFEPAK 12 monitor are intended to provide documentation of the patient's vital signs and ST segment measurements for up to 8 hours. When configured on, each active vital sign parameter and ST measurement can be displayed graphically for time ranges of 30 minutes and 1, 2, 4, and 8 hours. The vital signs are HR, SpO2, CO2, RR, and systolic, diastolic and mean pressures. Data is sampled every 30 seconds. If valid data is not available, a blank space is substituted. NIBP values are plotted only when a NIBP measurement is obtained. There is no averaging or filtering of the VS and ST measurements.

ST monitoring is initiated with the patient's first 12-lead ECG. The ST median (STM) measurement is derived from the GE Medical Systems 12SL ECG analysis program. (See Figure 3-15.)

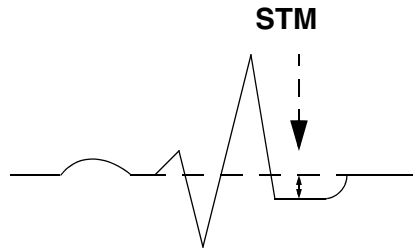

Figure 3-15 ST Median Measurement

After analyzing a 12-lead ECG, the monitor identifies the lead with the most STM displacement, either negative or positive. This lead automatically appears with *AUTO* selected. This first STM measurement for each lead becomes the baseline. All subsequent STM measurements are compared against this baseline. The lead identifier, the current STM measurement, and the difference between the current measurement and the baseline measurement are displayed. A graph of the change history of STM measurements is also displayed. The graph represents the change in the STM measurement from the baseline. (See Figure 3-16.) To determine the baseline STM, subtract the number representing the baseline change from the current STM measurement. The example in Figure 3-16, shows the current STM measurement is 5.2 mm. This measurement represents a change from the baseline of 5.2 mm, therefore, the baseline measurement was 0 mm (5.2 minus 5.2 = 0). Alternatively, print the Trend Summary report. The baseline ST measurement is annotated below the ST graph.

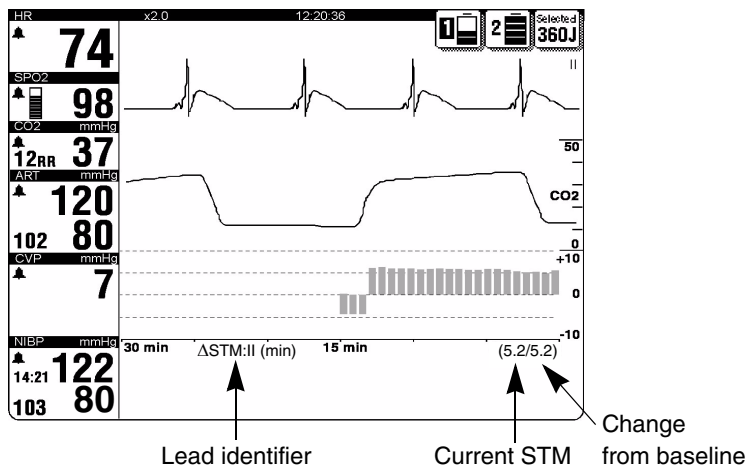

Figure 3-16 ST Graph

The user may elect to display the ST measurement graph of any other available lead if desired. As long as all the leads of the 12-lead ECG cable are attached to the patient, ST measurements will be obtained automatically. If the 12-lead ECG data is too noisy, ST measurements will not be displayed and the graph will be blank for that time period. If a STM measurement in any lead deviates from the baseline measurement by 1 mm (0.1 mV) or more and this deviation persists for 2.5 minutes, the monitor will automatically acquire another 12-lead ECG.

VS and ST Monitoring Considerations

As with any monitoring parameter, there are clinical considerations that can affect the usefulness of the measurements obtained. To help ensure the best results, consider the following factors.

- Ability of the patient to cooperate and be relaxed. Patients who are restless can produce noisy physiological signals. Noisy signals can result in inaccurately high or low data measurements.
- Quality of the physiological signal. If the ECG has significant artifact, the HR may have spurious measurements. Noisy 12-lead ECGs may need to be overridden, and ST measurements will not appear.
- Expected length of time the patient is to be monitored. VS graphs of the patient monitored for only a short time (for example, 15 minutes) may not provide enough data to identify gradual changes in patient condition.
- Patient ECG rhythm. Diagnosis of ST associated ischemia is inhibited by certain ECG findings, such as, left bundle branch block and ventricular pacing.

VS and ST Monitoring Procedure

The user may elect to display the VS graph for any active parameter or the ST measurement graph on Channel 2 or 3. Channel 3 is used as an example in the following procedure.

- 1 Using the **SELECTOR** knob, select Channel 3 on the monitor screen. The Channel 3 menu appears.
- 2 Select **WAVEFORM**, then select **TREND** from the list.
- 3 Select **SOURCE**, then select the desired parameter from the list.
- 4 **AUTO** for **SCALE** and **RANGE** are preselected and are the recommended settings to use. Otherwise, select the scale and range desired.
- 5 Press the **HOME SCREEN** button. The graph for the selected parameter appears.

When **AUTO** is selected for scale and range, the monitor automatically updates the scale so that all values are displayed and automatically updates the range so that all the data from power on to present time is visible. If scales and ranges other than **AUTO** are selected, some of the data may not be visible because it is off scale or out of range.

Note: To initiate ST monitoring, you must obtain a 12-lead ECG.

THERAPY

This section describes patient therapy.

General Therapy Warnings and Cautions	page 4-2
Therapy Electrode and Standard Paddle Placement	4-3
Automated External Defibrillation	4-4
Manual Defibrillation	4-13
Noninvasive Pacing	4-18

GENERAL THERAPY WARNINGS AND CAUTIONS**WARNINGS!****Shock hazard.**

The defibrillator delivers up to 360 joules of electrical energy. When discharging the defibrillator, do not touch the paddle electrode surfaces or disposable therapy electrodes.

Shock hazard.

If a person is touching the patient, bed, or any conductive material in contact with the patient during defibrillation, the delivered energy may be partially discharged through that person. Clear everyone away from contact with the patient, bed, and other conductive material before discharging the defibrillator.

Shock hazard.

Do not discharge the defibrillator into the open air. To remove an unwanted charge, change the energy selection, select disarm, or turn off the defibrillator.

Possible fire, burns, and ineffective energy delivery.

Do not discharge standard paddles on top of therapy electrodes or ECG electrodes. Do not allow standard paddles (or therapy electrodes) to touch each other, ECG electrodes, lead wires, dressings, transdermal patches, etc. Such contact can cause electrical arcing and patient skin burns during defibrillation and may divert defibrillating energy away from the heart muscle.

Possible defibrillator shutdown.

The large current draw required for defibrillator charging may cause the defibrillator to reach a shutdown voltage level with no low battery indication. If the defibrillator shuts down without warning or if a replace battery warning occurs, immediately replace the battery with another fully charged battery.

Possible skin burns.

During defibrillation or pacing, air pockets between the skin and therapy electrodes may cause patient skin burns. Apply therapy electrodes so that entire electrode adheres to skin. Do not reposition the electrodes once applied. If the position must be changed, remove and replace with new electrodes.

Possible skin burns and ineffective energy delivery.

Therapy electrodes that are dried out or damaged may cause electrical arcing and patient skin burns during defibrillation. Do not use therapy electrodes that have been removed from foil package for more than 24 hours. Do not use electrodes beyond expiration date. Check that electrode adhesive is intact and undamaged. Replace therapy electrodes after 50 shocks.

Possible interference with implanted electrical device.

Defibrillation may cause implanted devices to malfunction. Place standard paddles or therapy electrodes away from implanted devices if possible. Check implanted device function after defibrillation.

CAUTION!**Possible equipment damage.**

Prior to using this defibrillator, disconnect from the patient all equipment that is not defibrillator-protected.

THErapy ELECTRODE AND STANDARD PADDLE PLACEMENT

The following paragraphs describe therapy electrode and standard paddle placement, including special placement situations.

Anterior-lateral Placement

Anterior-lateral placement allows for ECG monitoring, defibrillation, synchronized cardioversion, and noninvasive pacing.

- 1 Place either the ♥ or + therapy electrode, or APEX paddle lateral to the patient's left nipple in the midaxillary line, with the center of the electrode in the midaxillary line, if possible. See Figure 4-1.

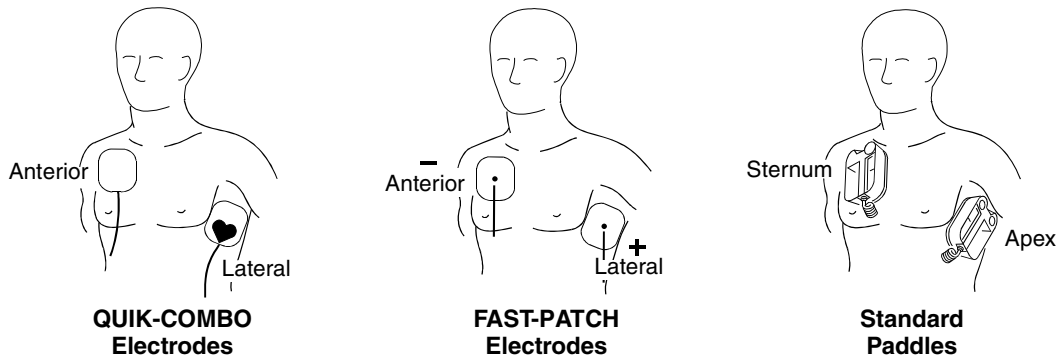

Figure 4-1 Anterior-lateral Placement

- 2 Place the other therapy electrode or STERNUM paddle on the patient's upper right torso, lateral to the sternum, and below the clavicle as shown in Figure 4-1.

Anterior-posterior Placement

Anterior-posterior is an alternative position for noninvasive pacing, manual defibrillation, and synchronized cardioversion, but not for ECG monitoring or automated defibrillation. The ECG signal obtained through electrodes in this position is not a standard lead.

- 1 Place either the ♥ or + therapy electrode over the left precordium as shown in Figure 4-2. The upper edge of the electrode should be below the nipple. Avoid placement over the nipple, the diaphragm, or the bony prominence of the sternum if possible.
- 2 Place the other electrode behind the heart in the infrascapular area as shown in Figure 4-2. For patient comfort, place the cable connection away from the spine. Do not place the electrode over the bony prominences of the spine or scapula.

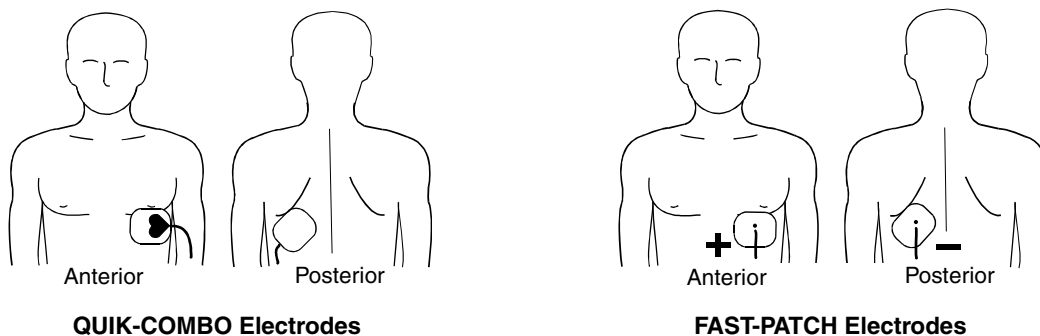

Figure 4-2 Anterior-posterior Placement for Defibrillation and Pacing

To use standard paddles for anterior-posterior placement, use the posterior paddle (MIN 802461) and refer to Section 5, "Paddle Accessory Options."

AUTOMATED EXTERNAL DEFIBRILLATION

The following paragraphs include:

- AED Warnings
- AED Configuration
- AED Procedure
- Special AED Setup Options
- Advisory Mode Monitoring
- Troubleshooting Tips for AED Mode

AED Warnings

WARNINGS!

Possible misinterpretation of data.

Do not analyze in a moving vehicle. Motion artifact may affect the ECG signal resulting in an inappropriate shock or no shock advised message. Motion detection may delay analysis. Stop vehicle and stand clear of patient during analysis.

Possible ECG misinterpretation.

Do not place therapy electrodes in the anterior-posterior position when operating this defibrillator in AED mode. A shock or no shock decision may be inappropriately advised. The shock advisory algorithm requires the electrodes to be placed in the anterior-lateral (Lead II) position.

Pediatric patient safety risk.

In AED mode, this defibrillator is not designed or tested to interpret pediatric rhythms or administer energy at pediatric joule settings.

AED Configuration

You can configure the LIFEPAK 12 defibrillator/monitor to power on in the automated external defibrillator (AED) mode before placing the device into use (refer to Section 9, "Defining Setup Options"). To power on in AED mode, set the Monitoring menu default waveform to **PADDLES** and **Manual Access** to one of the AED/xxxxx choices. When configured to power on in the AED mode, you will see the **ADVISORY** LED illuminated when the defibrillator is on.

AED Procedure

The following descriptions of voice prompts and messages are based on the factory default settings for AED mode. The default settings are consistent with 2005 American Heart Association (AHA) and European Resuscitation Council (ERC) guidelines. Changing the setup options may result in different AED behavior. Refer to Section 9, "Defining Setup Options" for setup option choices.

- 1 Verify that the patient is in cardiac arrest (unconscious, no respiration, no pulse).
- 2 Press **ON**.
- 3 Prepare the patient for electrode placement (refer to "Paddles Monitoring Procedure" on page 3-5).

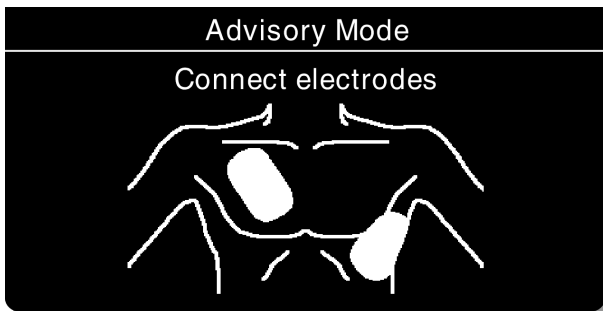

The CONNECT ELECTRODES message and voice prompt occur until the patient is connected to the AED. If possible, place the patient on a hard surface away from standing water or conductive material.

- 4 Connect the therapy electrodes to the therapy cable, and confirm cable connection to the defibrillator.
- 5 Apply the electrodes to the patient's chest in the anterior-lateral position (refer to "Anterior-lateral Placement" on page 4-3).

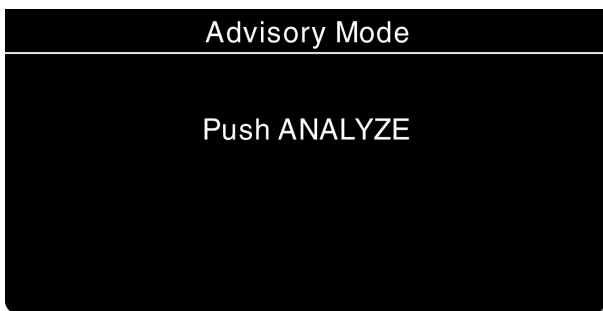

The PUSH ANALYZE message and voice prompt occur when the patient is properly connected to the AED. The PUSH ANALYZE message stays on the screen and the analyze LED flashes until ANALYZE is pressed.

- 6 Press ANALYZE to initiate analysis. Stop CPR.

WARNING!

Possible misinterpretation of data.

Do not move the AED during analysis. Moving the AED during analysis may affect the ECG signal resulting in an inappropriate shock or no shock advised decision. Do not touch the patient or the AED during analysis.

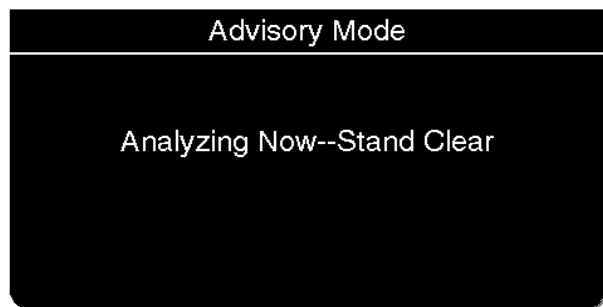

You see and hear ANALYZING NOW-- STAND CLEAR. Do not touch or move the patient or therapy cable during analysis.

ECG analysis requires approximately 6 to 9 seconds. The ANALYZE LED is on during analysis.

The SAS analyzes the patient's ECG and advises either SHOCK ADVISED or NO SHOCK ADVISED.

- 7 Follow the screen messages and voice prompts provided by the AED.

Shock Advised

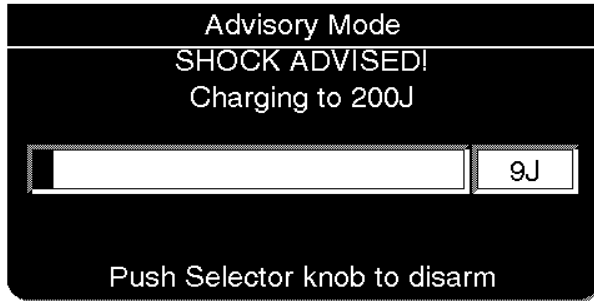

If the AED detects a shockable ECG rhythm, you see and hear **SHOCK ADVISED**. The AED begins charging to the joule setting for shock #1. A rising tone indicates that the AED is charging.

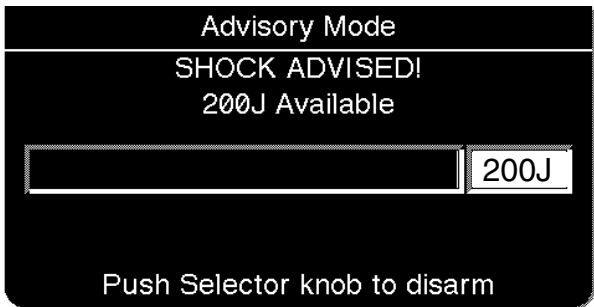

When charging is complete, the AED displays the available energy.

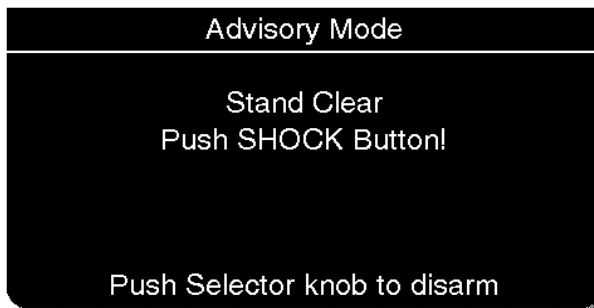

You see and hear **STAND CLEAR, PUSH SHOCK BUTTON**, followed by a "shock ready" tone. The **SHOCK LED** flashes. Clear everyone away from the patient, bed, or any equipment connected to the patient. Press **SHOCK** to deliver energy to the patient.

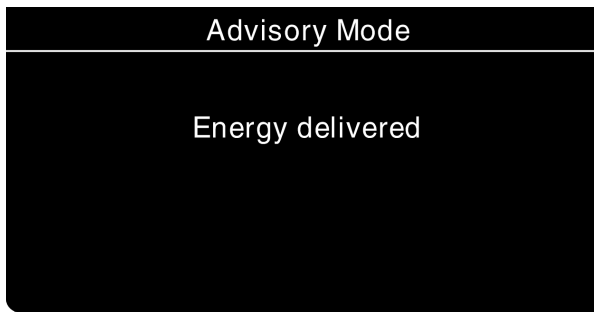

When the  button is pressed, you see the message **ENERGY DELIVERED**, indicating energy transfer was completed.

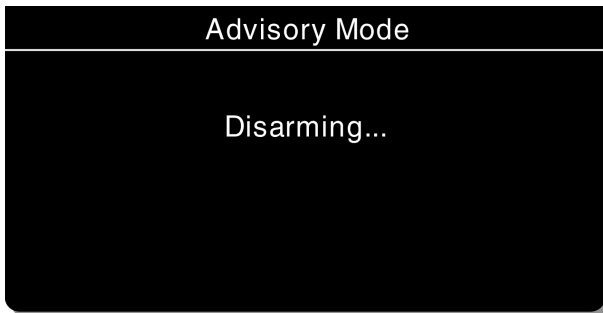

Note: If you do not press the  button within 60 seconds, the AED disarms the shock button, and the `DISARMING` message appears.

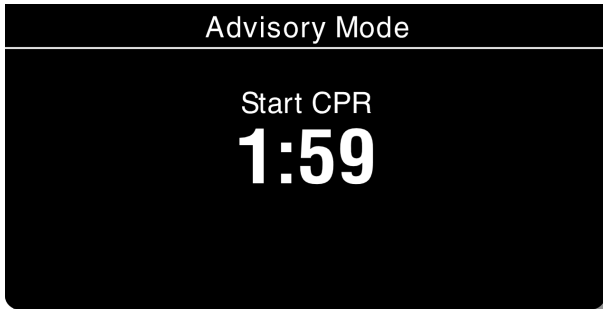

After a shock is delivered you see and hear `START CPR`. A countdown timer (min:sec format) continues for the duration specified in the `CPR TIME 1` setup option.

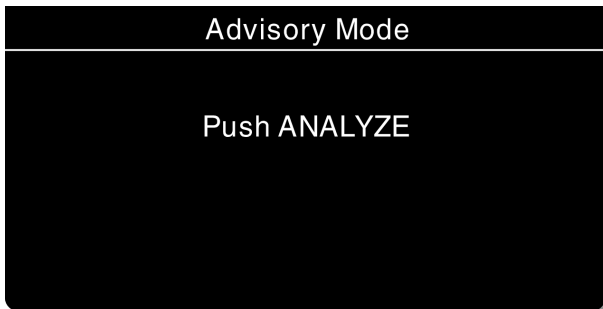

When the CPR countdown time ends, you see and hear `PUSH ANALYZE`. This message stays on the screen and the voice prompt repeats every 20 seconds until you press the `ANALYZE` button.

No Shock Advised

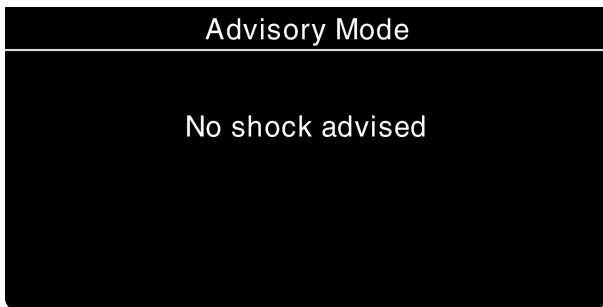

If the AED detects a nonshockable rhythm, you see and hear `NO SHOCK ADVISED`. The AED does not charge, and a shock cannot be delivered.

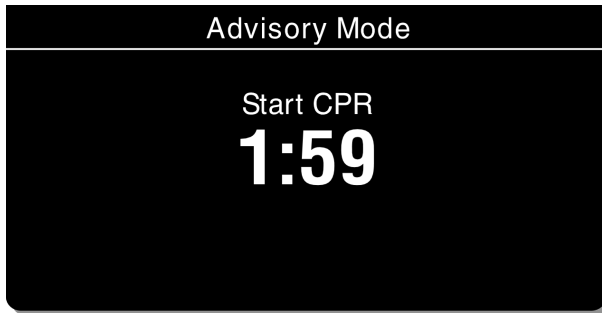

After a NO SHOCK ADVISED prompt, you see and hear START CPR. A countdown timer (min:sec format) continues for the duration specified in the CPR TIME 2 setup option.

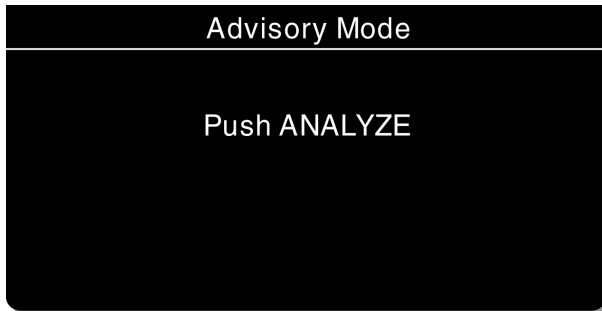

When the CPR countdown time ends, you see and hear PUSH ANALYZE. This message stays on the screen and the voice prompt repeats every 20 seconds until you press the ANALYZE button.

Subsequent analysis, SHOCK ADVISED, and NO SHOCK ADVISED sequences are the same as described above.

The energy levels for Shocks 2, 3, and greater depend on the ENERGY PROTOCOL setup and the analysis decision. When a NO SHOCK ADVISED decision follows a shock, the energy level will not increase for the next shock.

Motion Detected

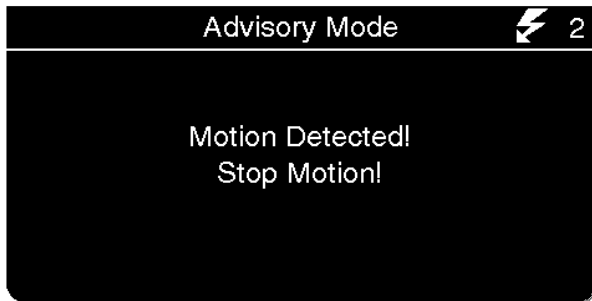

If the AED detects motion during the ECG analysis, you see and hear MOTION DETECTED, STOP MOTION, followed by a warning tone. Analysis is inhibited until the motion stops or for up to 10 seconds. After the motion ceases or 10 seconds have elapsed, analysis continues to completion even if motion is still present. Refer to Table 4-1 on page 4-12 for possible causes of motion detection and suggested solutions.

Electrodes Off

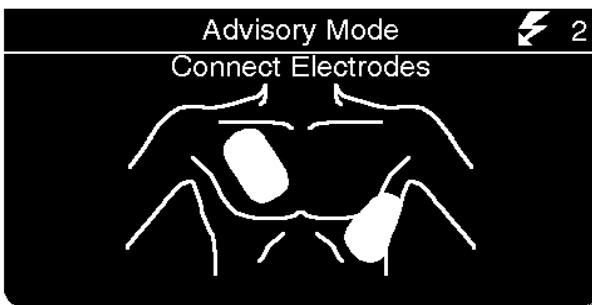

If therapy electrodes are not connected, the CONNECT ELECTRODES message and voice prompt occur until the patient is connected to the AED.

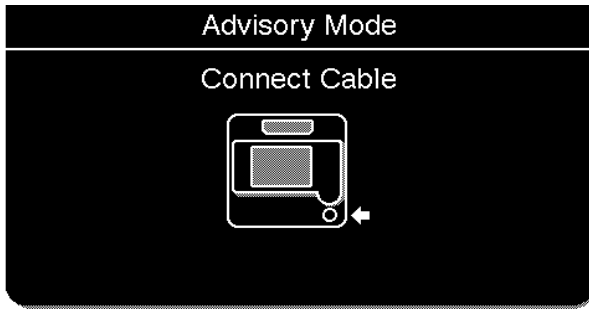

If the therapy cable is not connected to the defibrillator, you will see the **CONNECT CABLE** message until the cable is connected.

Shock Counter



The shock counter ⚡(x) indicates how many shocks have been delivered to the patient. The shock counter resets to zero whenever the defibrillator is turned off for longer than 30 seconds.

Special AED Setup Options

The following descriptions of voice prompts and messages explain special cprMAX technology setup options (refer to Appendix G, "About cprMAX Technology").

Initial CPR - CPR First

When the **INITIAL CPR** option is set to **CPR FIRST**, you are prompted to **START CPR** immediately after the AED is turned on.

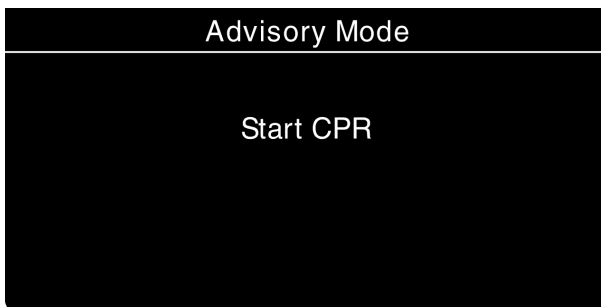

You see and hear **START CPR**.

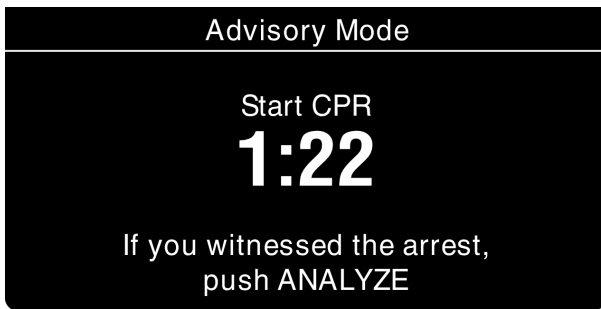

After 3 seconds, a countdown timer continues for the duration specified in the **initial CPR** period and you see and hear **IF YOU WITNESSED THE ARREST, PUSH ANALYZE**. This provides an opportunity to end the initial CPR early and proceed to analysis.

- If you did witness the arrest, you should press **ANALYZE** and proceed directly to analysis. This will end the CPR period and you will see and hear **ANALYZING NOW, STAND CLEAR**.

Note: The decision to end CPR early is based on your protocol.

- If you did not witness the arrest, you should perform CPR and not press **ANALYZE**. The Initial CPR countdown timer continues for the duration specified in the **INITIAL CPR TIME** setup option, for example, 90 seconds. When initial CPR time ends, you will see and hear **PUSH ANALYZE**.

Initial CPR - Analyze First

When the **INITIAL CPR** option is set to **ANALYZE FIRST**, you will be prompted to perform analysis after the AED is turned on. CPR is prompted after the AED completes the analysis.

If the electrodes are not attached to the patient, you will see and hear **CONNECT ELECTRODES** before you are prompted to perform analysis.

No Shock Advised



If the AED detects a nonshockable rhythm, you are prompted to **START CPR**. A countdown timer (min:sec format) continues for the duration specified in the **INITIAL CPR TIME** setup option. (Refer to Table 9-3).

When initial CPR time ends, you see and hear **NO SHOCK ADVISED** followed by **PUSH ANALYZE**.

Shock Advised

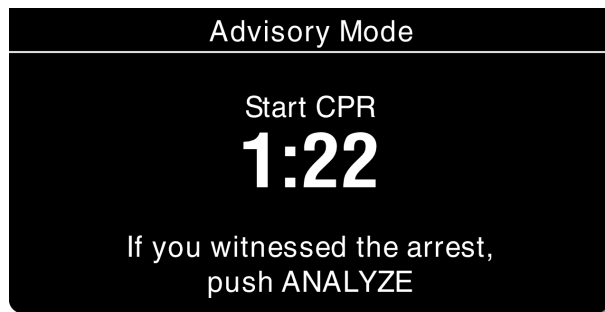

If the AED detects a shockable rhythm, you see and hear **START CPR** followed by **IF YOU WITNESSED THE ARREST, PUSH ANALYZE**. This provides an opportunity to end the initial CPR early and proceed directly to delivering a shock.

- If you did witness the arrest, you should press **ANALYZE** and proceed directly to shock. This will end the CPR period and you will see and hear **SHOCK ADVISED** and **STAND CLEAR, PUSH TO SHOCK (⚡)**. Proceed according to your training with the AED for delivering the shock.

Note: The decision to end CPR early is based on your protocol.

- If you did not witness the arrest, you should perform CPR and not press **ANALYZE**. The Initial CPR countdown timer continues for the duration specified in the **INITIAL CPR TIME** setup option, for example, 90 seconds. When initial CPR time ends, you will see and hear **SHOCK ADVISED**. Proceed according to your training with the AED for delivering a shock.

Preshock CPR Time

When **PRESHOCK CPR** time is set to 15 seconds or more, you are prompted to start CPR immediately after a shockable rhythm is detected, before the shock is delivered.



After analysis is complete, you see and hear **START CPR**. A countdown timer (min:sec format) continues for the duration specified in the **PRESHOCK CPR** time setup option (for example, 15 seconds).

When CPR time ends you then see and hear **SHOCK ADVISED**. Proceed according to your training with the AED for delivering a shock.

The **SHOCK** button is disabled during the **PRESHOCK CPR** interval to avoid accidental shock delivery while the defibrillator is charged and a responder is performing CPR.

Advisory Monitoring

Advisory Monitoring is a special way to set up AED mode that allows the use of all the monitoring functions without initiating the AED prompted protocol when the device is turned on. When needed, the AED mode prompted protocol can be initiated by pressing **ANALYZE**. In addition, access to manual mode therapies—that is, manual defibrillation, sync cardioversion, or pacing—by unauthorized users can be restricted, if necessary.

Certain setup options must be changed for the device to operate in Advisory Monitoring when it is turned on. For more information, refer to Section 9, "Defining Setup Options." In the Manual Mode Setup menu, select one of the **AED/xxxx Manual Access** choices. In the Monitoring menu, set the Channels Setup menu default waveform to Lead II.

When set up for Advisory Monitoring and the monitor is turned on, the **ADVISORY MODE-MONITORING** message appears continuously in the message area on the Home Screen. Monitor functions such as NIBP, SpO₂ and 12-lead ECG can be used. Lead II and dashes are shown in the top ECG trace (Channel 1) unless or until the patient is connected to the ECG cable. If therapy electrodes (pads) and the therapy cable are connected to the patient, press **LEAD** to change to **PADDLES** lead and view the ECG.

In Advisory Monitoring, **LEAD II** and **PADDLES** lead are the only ECG monitoring leads allowed in Channel 1. The Continuous Patient Surveillance System (CPSS) is active and automatically evaluates the patient ECG. However, CPSS is evaluating only for a potentially shockable rhythm. If a shockable ECG rhythm such as VF is detected, the **PUSH ANALYZE** prompt occurs.

Pressing **ANALYZE** causes the device to enter AED Mode. Prior to pressing **ANALYZE**, confirm that the patient is in cardiac arrest. Motion artifact, a low amplitude ECG, and other causes of poor ECG signal may cause false CPSS alerts. If the patient is not in cardiac arrest, do not press **ANALYZE**. Troubleshoot the cause of the false CPSS alert.

If the patient is in cardiac arrest, press **ANALYZE**. The defibrillator begins the AED prompted protocol and analyzes the patient's ECG when therapy electrodes are applied to the patient. For more information about defibrillator behavior in AED mode, see "Automated External Defibrillation" on page 4-4.

CPSS only evaluates for shockable ECG rhythms. If the ECG rhythm is nonshockable, for example asystole, no prompting occurs. Users who are not trained to interpret ECGs or are trained only to use AED mode must always press **ANALYZE** when using this special setup function to initiate ECG analysis and AED prompting.

For information about limiting access to manual mode by unauthorized users, refer to "Manual Mode Setup Menu" on page 9-4.

Troubleshooting Tips for AED Mode

Table 4-1 Troubleshooting Tips for AED Mode

Observation	Possible Cause	Corrective Action
1 CONNECT ELECTRODES message appears.	Inadequate connection to defibrillator.	<ul style="list-style-type: none"> • Check for electrode connection.
	Electrodes do not adhere properly to the patient.	<ul style="list-style-type: none"> • Press electrodes firmly on patient's skin. • Clean, shave, and dry the patient's skin as recommended. • Apply new electrodes.
	Electrodes are dry, damaged, or out of date.	<ul style="list-style-type: none"> • Apply new electrodes.
2 MOTION DETECTED and STOP MOTION messages appear during analysis.	Patient movement.	<ul style="list-style-type: none"> • Stop CPR during analysis. • When patient is being manually ventilated, press ANALYZE after complete exhalation.
	Patient movement because of agonal respirations.	<ul style="list-style-type: none"> • Allow analysis to proceed to completion—analysis will be delayed no more than 10 seconds due to motion detection.
	Electrical/radio frequency interference.	<ul style="list-style-type: none"> • Move hand-held communication devices or other suspected devices away from the defibrillator when possible.
	Vehicle motion.	<ul style="list-style-type: none"> • Stop vehicle during analysis. • Move patient to stable location when possible.
3 CHARGE REMOVED message appears.	Electrode disconnected from patient or AED.	<ul style="list-style-type: none"> • Replace electrode and press ANALYZE.
	Shock button not pressed within 60 seconds.	<ul style="list-style-type: none"> • Press ANALYZE again. • Press SHOCK immediately when directed.
4 Voice prompts sound faint or distorted.	Low battery power.	<ul style="list-style-type: none"> • Replace the battery immediately.

MANUAL DEFIBRILLATION

The following paragraphs describe:

- Manual Defibrillation Warnings
- Switching from AED to Manual Mode
- Defibrillation Shock Overlays
- Defibrillation Procedure
- Synchronized Cardioversion Procedure
- Troubleshooting Tips for Defibrillation and Synchronized Cardioversion

Manual Defibrillation Warnings

WARNINGS!

Possible fire, burns, and ineffective energy delivery.

Precordial lead electrodes and lead wires may interfere with the placement of standard paddles or therapy electrodes. Before defibrillation, remove any interfering precordial lead electrodes and lead wires.

Shock hazard.

Conductive gel (wet or dry) on the paddle handles can allow the electrical energy to discharge through the operator during defibrillation. Completely clean the paddle electrode surfaces, handles, and storage area after defibrillation.

Possible patient skin burns.

During defibrillation, air pockets between the skin and standard paddles can cause patient skin burns. Completely cover paddle electrode surfaces with fresh conductive gel and apply 25lbs. of pressure per paddle during discharge.

Possible paddle damage and patient skin burns.

Discharging the defibrillator with the standard paddle surfaces shorted together can pit or damage the paddle electrode surface. Pitted or damaged paddle surfaces may cause patient skin burns during defibrillation. Discharge the defibrillator only as described in these Operating Instructions.

Possible burns and ineffective energy delivery.

A gel pathway on the skin between the standard paddles will cause defibrillating energy to arc between paddles and divert energy away from the heart muscle. Do not allow conductive gel (wet or dry) to become continuous between paddle sites.

The LIFEPAK 12 defibrillator/monitor is shipped ready to use as a manual defibrillator and a monitor with Lead II as the default ECG lead. To change the defibrillator or monitor settings, refer to Section 9, "Defining Setup Options."

Switching from AED to Manual Mode

To change to manual mode when the defibrillator is in AED mode, press one of the following:

- ENERGY SELECT
- CHARGE
- PACER
- ADVISORY

Depending on how the defibrillator is configured, continue to manual mode as follows:

- **Direct.** No restrictions to manual mode access.
- **Confirmed.** A confirmation overlay appears:

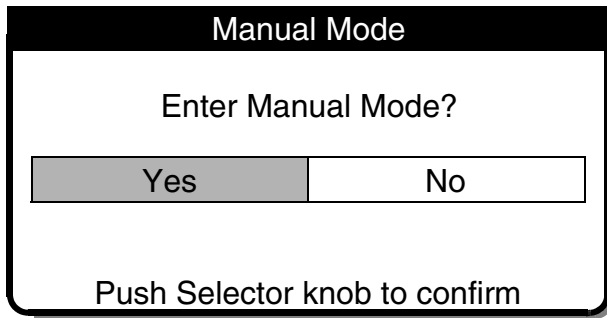

Select YES to change to manual mode.

- **Passcode.** A passcode overlay appears:

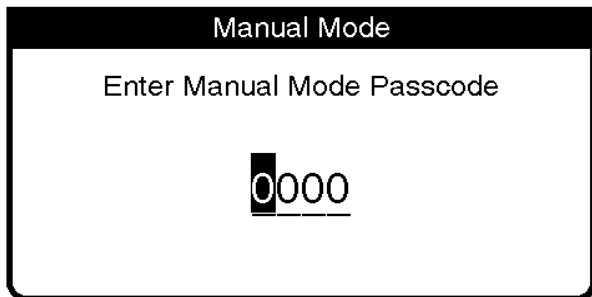

Enter the Passcode to change to manual mode.

- **Restricted.** The defibrillator can also be configured to deny access to manual mode. If you try to access the manual mode when it is configured to restrict access, a MANUAL DISABLED message flashes, a tone sounds, and the defibrillator stays in AED mode.

See Section 9 for information about changing the defibrillation mode configuration.

Defibrillation Shock Overlays

Depending on the paddles accessory connected for defibrillation, you will see the following overlays when the defibrillator is fully charged.

QUIK-COMBO or FAST-PATCH Electrodes

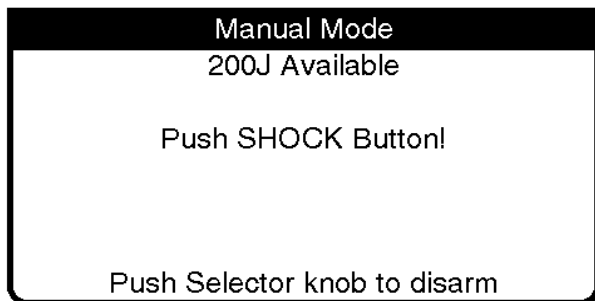

Press SHOCK on front panel to discharge energy.

Standard Paddles

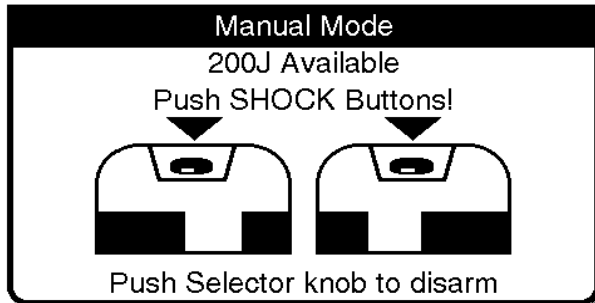

Press both shock buttons simultaneously to discharge energy.
Front panel SHOCK button is disabled.

Internal Paddles

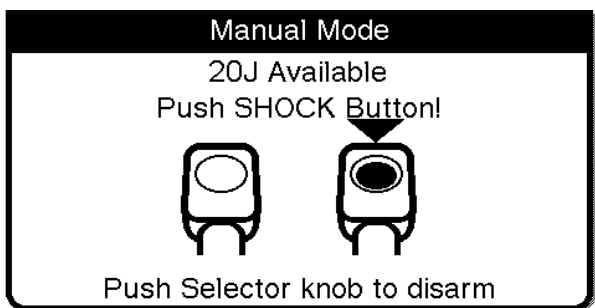

Press shock button on handle of internal paddle to discharge energy.
Front panel SHOCK button is disabled.

Defibrillation Procedure

- 1 Press ON.
- 2 Identify the electrode or paddle sites on the patient. Use either the anterior-lateral or anterior-posterior position as described on page 4-3.
- 3 Prepare the patient's skin for electrode application:
 - If possible, place the patient on a hard surface away from standing water or conductive material.
 - Remove clothing from the patient's upper torso.
 - Remove excessive hair from the electrode sites; if shaving is necessary, avoid cutting the skin.
 - Clean the skin and dry it briskly with a towel or gauze.
 - Do not apply alcohol, tincture of benzoin, or antiperspirant to the skin.
- 4 Connect the therapy electrodes to the therapy cable and confirm cable connection to the device.
- 5 Apply therapy electrodes to the patient in anterior-lateral or anterior-posterior position. If using standard paddles, apply conductive gel to the paddles and place paddles on the patient's chest.
- 6 Press ENERGY SELECT or rotate ENERGY SELECT dial on standard paddles.
- 7 Press CHARGE. While the defibrillator is charging, a charging bar appears and a ramping tone sounds, indicating the charging energy level. When the defibrillator is fully charged, an overlay appears (see "Defibrillation Shock Overlays" on page 4-14).
- 8 Make certain all personnel, including the operator, stand clear of the patient, bed, and any equipment connected to the patient.
- 9 Confirm ECG rhythm. Confirm available energy.
- 10 Press the SHOCK button(s) to discharge energy to the patient or press the SELECTOR to remove the charge.

If discharge buttons are not pressed within 60 seconds, the stored energy is internally removed.

Note: If you change the energy selection after charging has started, the energy is removed internally. Press CHARGE to restart charging.

11 Observe the patient and the ECG rhythm. If an additional shock is necessary, repeat the procedure beginning at Step 6.

Note: You can configure the LIFEPAK 12 defibrillator/monitor to automatically sequence energy levels (refer to "Manual Mode Setup Menu" on page 9-4).

For more information about defibrillation, refer to the booklet, *Defibrillation: What You Should Know*.

Synchronized Cardioversion Procedure

Note: The LIFEPAK 12 defibrillator/monitor can be configured to remain in SYNC mode or to return to asynchronous mode after discharge. It is important that you know how your defibrillator is configured. See "Manual Mode Setup Menu" on page 9-4.

- 1 Press ON.
- 2 Attach patient ECG cable and ECG electrodes as previously described on page 3-5 and page 3-6.
- 3 Select Lead II or lead with greatest QRS complex amplitude (positive or negative).

Note: To monitor the ECG through therapy electrodes, place the electrodes in anterior-lateral position and select PADDLES lead.

WARNING!

Possible lethal arrhythmia.

Ventricular fibrillation may be induced with improper synchronization. DO NOT use the ECG from another monitor (slaving) to synchronize the LIFEPAK 12 defibrillator/monitor's discharge. Always monitor the patient's ECG directly through the ECG cable or therapy cable. Confirm proper placement of the sense markers on the ECG.

- 4 Press SYNC. Confirm the SYNC LED blinks with each detected QRS complex.
Note: Press SYNC again to deactivate sync mode.
- 5 Observe the ECG rhythm. Confirm that a triangle sense marker appears near the middle of each QRS complex. If the sense markers do not appear or are displayed in the wrong locations (for example, on the T-wave), adjust ECG SIZE or select another lead. (It is normal for the sense marker location to vary slightly on each QRS complex.)
- 6 Prepare the patient's skin for therapy electrode application as described in Step 3 of the Defibrillation Procedure.
- 7 Connect the therapy electrodes to the therapy cable and confirm cable connection to the device.
- 8 Apply therapy electrodes to the patient in the anterior-lateral position. If using standard paddles, apply conductive gel to the paddles and place paddles on the patient's chest.
- 9 Press ENERGY SELECT or rotate the ENERGY SELECT dial on the standard paddles.
- 10 Press CHARGE.
- 11 Make certain all personnel, including operator, stand clear of the patient, bed, and any equipment connected to the patient.
- 12 Confirm ECG rhythm. Confirm available energy.
- 13 Press and **hold** SHOCK button(s) until discharge occurs with next detected QRS complex. Release SHOCK buttons.
If discharge buttons are not pressed within 60 seconds, the stored energy is internally removed.
Note: If you change the energy selection after charging has started, the energy is removed internally. Press CHARGE to restart charging.
- 14 Observe patient and ECG rhythm. Repeat procedure from Step 4, if necessary.

Troubleshooting Tips for Defibrillation and Synchronized Cardioversion

Table 4-2 Troubleshooting Tips for Defibrillation and Synchronized Cardioversion

Observation	Possible Cause	Corrective Action
1 Charge time to 360 joules exceeds 10 seconds.	Battery low.	<ul style="list-style-type: none"> • Replace battery with fully charged battery. • Use power adapter. • Device operating in low temperature environment (<25° C).
2 Energy not delivered to patient when SHOCK button(s) are pressed.	Device in SYNC mode and QRS complexes are not detected.	<ul style="list-style-type: none"> • Adjust ECG size for optimum sensing QRS or deactivate SYNC.
	SYNC button accidentally pushed.	<ul style="list-style-type: none"> • Press SYNC button to turn off SYNC. • Press SHOCK buttons.
	Device in SYNC mode and button(s) not pressed and held until next detected QRS.	<ul style="list-style-type: none"> • Hold SHOCK buttons until discharge occurs or next detected QRS.
	SHOCK button(s) pressed before full charge reached.	<ul style="list-style-type: none"> • Wait for tone and message indicating full charge.
	Sixty seconds elapsed before SHOCK button(s) pressed after full charge. Energy internally removed.	<ul style="list-style-type: none"> • Press SHOCK button(s) within 60 seconds of full charge.
3 CONNECT CABLE or ENERGY NOT DELIVERED message appears.	ENERGY Selection changed.	<ul style="list-style-type: none"> • Press CHARGE again.
	Therapy cable became disconnected and energy removed internally.	<ul style="list-style-type: none"> • Reconnect cable and press charge again.
4 ENERGY FAULT message appears (selected and available energy).	Defibrillator is out of calibration.	<ul style="list-style-type: none"> • May transfer energy. • Contact a qualified service technician.
5 Disarming message appears.	Discharge button not pressed within 60 seconds after charge complete.	<ul style="list-style-type: none"> • Recharge the defibrillator if desired.
	Energy selected after charge complete.	<ul style="list-style-type: none"> • Recharge the defibrillator.
	Therapy cable disconnects.	<ul style="list-style-type: none"> • Reconnect electrode/cable.
6 Patient didn't "jump" (no muscle response) during defibrillator discharge.	Patient muscle response is variable and depends on patient condition. Lack of visible response to defibrillation does not necessarily mean the discharge did not occur.	<ul style="list-style-type: none"> • No action needed.
7 ENERGY NOT DELIVERED message appears and Shock XJ Not Delivered annotated on printout (devices with monophasic defibrillation waveform only).	Open air discharge with standard paddles.	<ul style="list-style-type: none"> • Press paddles firmly on patient's chest when discharging. • Perform test discharges with standard paddle tester.

Table 4-2 Troubleshooting Tips for Defibrillation and Synchronized Cardioversion (Continued)

Observation	Possible Cause	Corrective Action
8 ABNORMAL ENERGY DELIVERY message appears and Shock XJ Abnormal annotated on printout (devices with biphasic defibrillation waveform only).	Open air discharge with standard paddles.	<ul style="list-style-type: none"> Press paddles firmly on patient's chest when discharging. Perform test discharges with standard paddle tester.
	Discharge occurs with standard paddles shorted together.	<ul style="list-style-type: none"> Refer to warning on page 4-13.
	Patient impedance out of range.	<ul style="list-style-type: none"> Increase energy and/or repeat discharges as needed. Consider replacing disposable therapy electrodes with new.
9 CONNECT ELECTRODES message appears.	Inadequate connection to defibrillator.	<ul style="list-style-type: none"> Check for electrode connection.
	Electrodes do not adhere properly to the patient.	<ul style="list-style-type: none"> Press electrodes firmly on patient's skin. Clean, shave, and dry the patient's skin as recommended. Apply new electrodes.
	Electrodes are dry, damaged, or out of date.	<ul style="list-style-type: none"> Apply new electrodes.

NONINVASIVE PACING

The LIFEPAK 12 defibrillator/monitor provides noninvasive pacing using QUIK-COMBO electrodes.

The following paragraphs include:

- Noninvasive Pacing Warnings
- Demand and Nondemand Pacing
- Noninvasive Pacing Procedure
- Troubleshooting Tips for Noninvasive Pacing

Noninvasive Pacing Warnings

WARNINGS!

Possible inducement of ventricular fibrillation.

Sinus bradycardia may be physiologic in severe hypothermia (i.e., appropriate to maintain sufficient oxygen delivery when hypothermia is present), and cardiac pacing is usually not indicated.

Possible interruption of therapy.

Observe the patient continuously while the pacemaker is in use. Patient response to pacing therapy (for example, capture threshold) may change over time.

Possible inability to pace.

Using other manufacturers' combination therapy electrodes with this device could cause a decrease in pacing efficacy or the inability to pace because of unacceptably high impedance levels.

Possible ineffective pacing.

WARNINGS!

The ECG size must be properly adjusted so that the patient's own beats are detected. If ECG size is set too high or too low, pacing pulses may not be delivered when required. Adjust ECG size so that sense markers are placed on the patient's QRS complexes.

Possible patient skin burns.

Prolonged noninvasive pacing may cause patient skin irritation and burns, especially with higher pacing current levels. Discontinue noninvasive pacing if skin becomes burned and another method of pacing is available. Refer to "Therapy Electrodes" on page 5-2 for additional information about therapy electrodes.

Demand and Nondemand Pacing

The LIFEPAK 12 defibrillator/monitor can be used for either demand or nondemand (asynchronous) pacing.

The demand mode is used for most patients. In the demand mode, the LIFEPAK 12 defibrillator/monitor/pacemaker inhibits pacing output when it "senses" the patient's own beats (intrinsic QRSs). In demand mode, if the ECG SIZE is set too low to detect the patient's beats, or if an ECG lead becomes detached so that the ECG rhythm is not present, the pacemaker generates pacing pulses asynchronously. This means that the pacemaker generates pacing pulses at the selected rate regardless of the patient's ECG rhythm.

Asynchronous or nondemand mode can be selected if noise or artifact interferes with proper sensing of QRS complexes. Press the **OPTIONS** button to access the nondemand mode. See page 2-9.

Noninvasive Pacing Procedure

ECG monitoring during pacing must be performed with the ECG electrodes and patient ECG cable. Pacing therapy electrodes cannot be used to monitor ECG rhythm and deliver pacing current at the same time. Be sure to place the therapy electrodes in the proper locations as described in the pacing procedure. Improper placement of the electrodes may make a difference in the capture threshold.

To pace, perform the following:

- 1 Press **ON**.
- 2 Connect the patient ECG cable, apply ECG electrodes to the ECG cable and patient, and select Lead I, II, or III. To receive the best monitoring signal, make sure there is adequate space between the ECG electrodes and the therapy electrodes.
- 3 Identify the **QUIK-COMBO** electrode sites on the patient. For pacing, use either the anterior-lateral or anterior-posterior position (refer to page 4-3).
- 4 Prepare patient's skin for electrode application as described in Step 3 of the Defibrillation Procedure.
- 5 Apply **QUIK-COMBO** electrodes to the patient.
- 6 Connect the therapy electrodes to the therapy cable.
- 7 Press **PACER**. Confirm the LED illuminates, indicating that the pacemaker power is on.
- 8 Observe the ECG rhythm. Confirm that a triangle sense marker appears near the middle of each QRS complex. If the sense markers do not appear or are displayed in the wrong location (for example, on the T-wave), adjust **ECG SIZE**, or select another lead. (It is normal for the sense marker location to vary slightly on each QRS complex.)
- 9 Press **RATE** or rotate the **SELECTOR** to select the desired pacing rate.
Note: The **RATE** button changes the rate in 10 ppm increments; the **SELECTOR** changes the rate in 5ppm increments.
- 10 Press **CURRENT** or rotate the **SELECTOR** to increase current until electrical capture occurs. For each delivered pacing stimulus, the **PACER** indicator flashes off and a positive pace marker displays on

Therapy

the ECG waveform. Palpate patient's pulse or check blood pressure to assess for mechanical capture. Consider use of sedation or analgesia if patient is uncomfortable.

Note: The **CURRENT** button changes the current in 10 mA increments; the **SELECTOR** changes the current in 5 mA increments.

Note: To change rate or current during pacing, press **RATE** or **CURRENT**. Then, rotate the **SELECTOR**.

Note: To interrupt pacing and view the patient's intrinsic rhythm, press and hold the **PAUSE** button. This causes the pacer to pace at 25% of the set rate. Release the **PAUSE** button to resume pacing at the set rate.

11 To stop pacing, reduce current to zero or press **PACER**.

Note: To defibrillate and stop noninvasive pacing, press **ENERGY SELECT** or charge the defibrillator. Pacing automatically stops. Proceed with defibrillation.

If the monitor detects **ECG LEADS OFF** during pacing, pacing continues at a fixed rate until the ECG lead is reattached. During fixed-rate pacing, the pacemaker delivers pulses at the set pace rate regardless of any intrinsic beats that the patient may have. The monitor continues to display the pacing rate (ppm) and the current (mA). To reestablish demand pacing, reattach the ECG lead.

While pacing, visually monitor the patient at all times, *do not* rely on the **ECG LEADS OFF** warning to detect changes in pacing function. Routinely assess for proper ECG sensing, pace pulse delivery, electrical capture, and mechanical capture.

If pacing electrodes detach during pacing, you will see **CONNECT ELECTRODES** and **PACING STOPPED** messages and hear an alarm. The pacing rate is maintained and the current resets to 0 mA. Reattaching the pacing electrodes silences the alarm and removes the **CONNECT ELECTRODES** message. The current remains at 0 mA until you increase the current manually.

Troubleshooting Tips for Noninvasive Pacing

Table 4-3 Troubleshooting Tips for Noninvasive Pacing

Observation	Possible Cause	Corrective Action
1 Device does not function when PACER is pressed.	Power off.	• Check if power is ON .
	Low battery.	• Replace battery with fully charged battery. • Use auxiliary power supply if available.
2 PACER LED on, but CURRENT (MA) will not increase.	Therapy electrodes off.	• Check for message displayed. • Inspect therapy cable and electrode connections.
3 PACER LED on, CURRENT (MA) >0, but pace markers absent (not pacing).	Pacing rate set below patient's intrinsic rate.	• Increase PPM .
	Pacer oversensing (ECG artifact, ECG size too high).	• Establish clean ECG; decrease ECG size. • Select nondemand pacing.

Table 4-3 Troubleshooting Tips for Noninvasive Pacing (Continued)

Observation	Possible Cause	Corrective Action
4 Pacing stops spontaneously.	PACER button pressed off.	<ul style="list-style-type: none"> Press PACER and increase the current.
	Internal error detected. Service message indicates an internal failure.	<ul style="list-style-type: none"> Check for service indicator. Cycle power and start pacing again. Obtain service by a qualified service technician.
	Therapy electrode off.	<ul style="list-style-type: none"> Check for message. Check pacing cable and electrode connections.
	ENERGY SELECT or CHARGE pressed.	<ul style="list-style-type: none"> Press PACER and increase current. Check for service message. Cycle power and start pacing again.
5 Monitor screen displays distortion while pacing.	Radio frequency interference.	<ul style="list-style-type: none"> Move radio equipment away from pacemaker.
	ECG electrodes not optimally placed with respect to pacing electrodes.	<ul style="list-style-type: none"> Reposition electrodes away from pacing electrodes. Select another lead (I, II, or III).
6 Capture does not occur with pacing stimulus.	Patient response to pacing is highly variable with respect to capture threshold and ECG distortion.	<ul style="list-style-type: none"> Consider changing pacing rate.
	Current (mA) set too low.	<ul style="list-style-type: none"> Increase pacing current. (Administer sedation/analgesia as needed.)
7 CONNECT ELECTRODES message appears.	Pacing cable/electrode disconnected.	<ul style="list-style-type: none"> Reconnect and set current.
	Electrodes not adhering to skin.	<ul style="list-style-type: none"> Prepare skin and apply new electrodes.
	Electrodes outdated.	<ul style="list-style-type: none"> Apply new electrodes and set current.
8 Pacing stops spontaneously and PACER FAULT message appears.	Internal error detected.	<ul style="list-style-type: none"> Cycle power and start pacing again. Obtain service by a qualified service technician.
9 Intrinsic QRS complexes not sensed when pacing.	ECG size too low.	<ul style="list-style-type: none"> Increase ECG SIZE or select another lead.
	Intrinsic QRS complexes are occurring during pacemaker's refractory period.	<ul style="list-style-type: none"> Adjust PPM.
10 Pacing starts spontaneously.	Patient's heart rate falls below set pacing rate.	<ul style="list-style-type: none"> Appropriate pacemaker function assess patient.
	During standby pacing, ECG lead disconnects.	<ul style="list-style-type: none"> Reconnect ECG lead.
11 Set pacing rate (ppm) and ECG paced rate do not appear to match.	Internal error detected.	<ul style="list-style-type: none"> Print ECG and calculate the pace rate.

Table 4-3 Troubleshooting Tips for Noninvasive Pacing (Continued)

Observation	Possible Cause	Corrective Action
12 Improper sensing (for example, sensing on T-waves).	QRS complex too small. T-wave too large.	<ul style="list-style-type: none">• Select another lead.• Adjust ECG size.

PADDLE ACCESSORY OPTIONS

Therapy Electrodes	page 5-2
Pediatric Paddles (PN 800418)	5-6
Sterilizable Internal Defibrillation Paddles	5-9

THERAPY ELECTRODES

The following paragraphs describe:

- About Therapy Electrodes
- Electrode Placement
- Cable Connection
- ECG Monitoring and Therapy Procedures
- Replacing and Removing Electrodes
- Testing
- Cleaning and Sterilizing

About Therapy Electrodes

There are two styles of pre-gelled, self-adhesive therapy electrodes available: QUIK-COMBO pacing/defibrillation/ECG electrodes and FAST-PATCH defibrillation/ECG electrodes (Figure 5-1). Both types of electrodes may be used for defibrillation, synchronized cardioversion, ECG monitoring, and pacing. To use FAST-PATCH electrodes for pacing with the LIFEPAK 12 defibrillator requires the addition of a FAST-PATCH defibrillation adapter cable (PN 3011030).

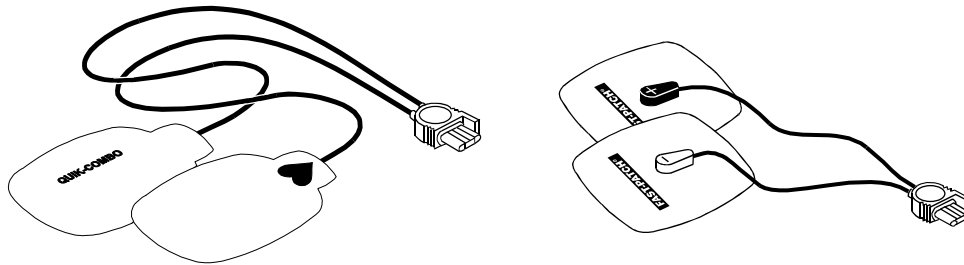

Figure 5-1 QUIK-COMBO and FAST-PATCH Electrodes

A QUIK-COMBO or FAST-PATCH electrode set:

- Is a substitute for standard paddles.
- Provides a Lead II monitoring signal when placed in the anterior-lateral position.
- Quickly restores the ECG trace on the monitor following defibrillation.

To help prevent electrode damage:

- Do not fold the electrodes.
- Do not trim the electrodes.
- Do not crush, fold, or store the electrodes under heavy objects.
- Store electrodes in a cool, dry location (59° to 95°F or 15° to 35°C).

There are several types of QUIK-COMBO electrodes available as described in Table 5-1:

Table 5-1 QUIK-COMBO Electrodes

Type	Description
QUIK-COMBO	Electrodes, with 2 feet of lead wire, designed for patients weighing 15 kg (33 lbs) or more.
QUIK-COMBO - RTS	Electrodes, providing a radio-transparent electrode and lead wire set, designed for patients weighing 15 kg (33 lbs) or more.
QUIK-COMBO with REDI-PAK™ preconnect system	Electrodes designed for patients weighing 15 kg (33 lbs) or more and allow preconnection of the electrode set to the device while maintaining electrode shelf life and integrity.
Pediatric QUIK-COMBO	Electrodes designed for patients weighing 15 kg (33 lbs) or less.

FAST-PATCH electrodes can be used on pediatric patients if the placement meets conditions noted directly below. These conditions can normally be met with children weighing 15 kg (33 lbs) or more.

Electrode Placement

When using QUIK-COMBO or FAST-PATCH electrodes, make sure the electrodes:

- Fit completely on the chest as described on page 3-4 or page 4-3.
- Have at least one inch of space between electrodes.
- Do not overlap bony prominences of sternum or spine.

To place the electrodes:

- 1 Prepare the patient for electrode placement:
 - Remove all clothing from the patient’s chest.
 - Remove excessive chest hair as much as possible. Avoid nicking or cutting the skin if using a shaver or razor. If possible, avoid placing the electrodes over broken skin.
 - Clean and dry the skin. If there is ointment on the patient’s chest, use soap and water to clean the skin. Briskly wipe the skin dry with a towel or gauze. This mildly abrades the skin and removes oils, dirt, and other debris for better electrode adhesion to the skin. Do not use alcohol, tincture of benzoin, or antiperspirant to prep the skin.
- 2 Slowly peel back the protective liner on the electrodes, beginning with the cable connection end (see Figure 5-2).

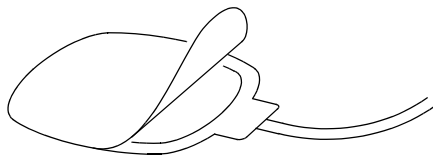

Figure 5-2 Peeling the Liner from the Electrode

- 3 Place the electrodes in the anterior-lateral or anterior-posterior position, as described on page 3-4 or page 4-3, depending on the therapy to be provided and special placement considerations.
- 4 Starting from one edge, firmly press the electrode on the patient’s chest to eliminate air pockets between the gel surface and the skin. Firmly press all adhesive edges to the skin.

Note: Once applied, therapy electrodes should not be repositioned.

Cable Connection

To connect QUIK-COMBO electrodes to the QUIK-COMBO therapy cable:

- 1 Open the protective cover on the QUIK-COMBO therapy cable connector (see Figure 5-3).
- 2 Insert the QUIK-COMBO electrode connector into the therapy cable connector by aligning the arrows and pressing the connectors firmly together for proper attachment.

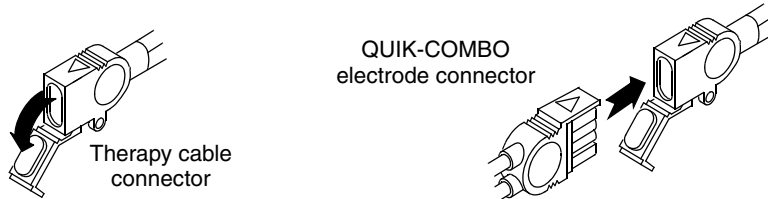

Figure 5-3 Connecting QUIK-COMBO Electrodes to Therapy Cable

To properly connect FAST-PATCH electrodes to the FAST-PATCH defibrillation adapter cable and ensure energy delivery:

- 1 When possible, attach the defibrillation cable to the electrode post before applying electrodes to the patient.
- 2 Support the electrode post when attaching the defibrillation cable (see Figure 5-4). Firmly press the cable onto the electrode until a click is heard or felt.



Figure 5-4 Connecting FAST-PATCH Electrodes to Defibrillation Cable

- 3 Pull up gently on the connector to confirm that the defibrillation cable is securely connected to the electrode.

ECG Monitoring and Therapy Procedures

WARNINGS!

Possible patient skin burns.

Do not use Pediatric QUIK-COMBO electrodes on adults or larger children. Delivery of defibrillation energies equal to or greater than 100 joules (typically used on adults) through these smaller electrodes increases the possibility of skin burns.

Possible pediatric patient skin burns.

Noninvasive pacing may cause patient skin irritation and burns, especially with higher pacing current levels. Inspect underlying skin of the ♥ electrode frequently after 30 minutes of continuous pacing. Discontinue noninvasive pacing if skin burn develops and another method of pacing is available. On cessation of pacing, immediately remove or replace electrodes with new ones.

For adult patients, follow the procedures for ECG monitoring, AED defibrillation, manual defibrillation, synchronized cardioversion, and pacing described in Section 3 or Section 4.

For pediatric patients, follow the procedures for ECG monitoring, manual defibrillation, synchronized cardioversion, and pacing except for the following:

- Select the appropriate defibrillation energy for the weight of the child according to the American Heart Association (AHA) recommendations or local protocol. Using energy levels of 100 joules or greater is likely to cause burns.

- When pacing, inspect the patient's skin under the heart electrode every 30 minutes for signs of burns.
Note: The amount of pacing current needed for capture is similar to the pacing current needed for adults.

Replacing and Removing Electrodes

Replace QUIK-COMBO or FAST-PATCH electrodes after 50 defibrillation shocks or 24 hours on the patient's skin or 8 hours of continuous pacing. Replace pediatric QUIK-COMBO electrodes after 25 defibrillation shocks or 24 hours on the patient's skin or 8 hours of continuous pacing.

To remove QUIK-COMBO or FAST-PATCH electrodes from the patient:

- 1 Slowly peel back the electrode from the edge, supporting the skin as shown in Figure 5-5.

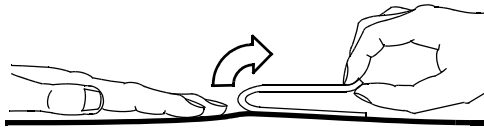

Figure 5-5 Removing Therapy Electrodes from Skin

- 2 Clean and dry the patient's skin.
- 3 When replacing electrodes, adjust the electrode positions slightly to help prevent skin burns.
- 4 Close the protective cover on the QUIK-COMBO therapy cable connector when the cable is not in use.

In addition, disconnect the defibrillation cable from the FAST-PATCH electrodes.

- 1 Press down around the electrode post.
- 2 Pinch the snap connector with the fingers of the other hand and pull straight up (see Figure 5-6).

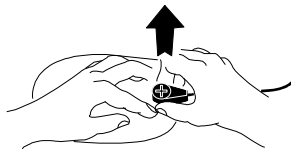

Figure 5-6 Disconnecting Defibrillation Cable from FAST-PATCH Electrodes

WARNING!

Possible cable damage and ineffective energy delivery or loss of monitoring.

Improper disconnection of the defibrillation cable may damage the cable wires. This can result in failure to deliver energy or loss of ECG signal during patient care. Position the cable so that it will not be pulled, snagged, or tripped over. Do not disconnect the defibrillation cable snap connectors from electrode posts or posts on testing devices by pulling on the cable. Disconnect the cable by pulling each cable connector straight out (see Figure 5-6 and Figure 5-7).

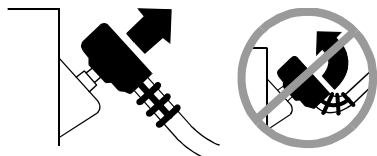

Figure 5-7 Disconnecting Defibrillation Cable from Test Post

Testing

Include inspecting and testing of the QUIK-COMBO therapy cable or FAST-PATCH defibrillation adapter cable as part of your defibrillator test routine. Daily inspection and testing will help ensure that the defibrillator cable and the therapy cable are in good operating condition and are ready for use when needed. (Refer to Appendix C, "Operator's Checklist.")

If you detect any discrepancy during inspection and testing, remove the therapy cable from use and immediately notify a qualified service technician.

Cleaning and Sterilizing

QUIK-COMBO and FAST-PATCH electrodes are not sterile or sterilizable. They are disposable and are for a single patient application. Do not autoclave, gas sterilize, immerse in fluids, or clean electrodes with alcohol or solvents.

PEDIATRIC PADDLES (PN 800418)

The following paragraphs describe:

- About Pediatric Paddles
- Attaching Pediatric Paddles
- Removing Pediatric Paddles
- Paddle Placement
- Defibrillation Procedure
- Cleaning

About Pediatric Paddles

Pediatric paddles slide onto adult paddles. Features of the QUIK-LOOK and QUIK-CHARGE® defibrillation paddles can be used with pediatric paddles in place.

Pediatric paddles should be used for patients weighing less than 10 kg (22 lbs) or for patients whose chest size cannot accommodate the adult hard paddles.

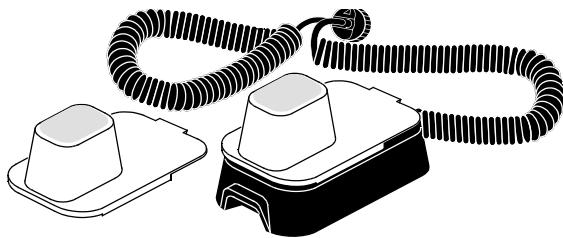

Figure 5-8 Pediatric Paddles

Each pediatric paddle attachment has a metal spring plate with a button on it to transfer defibrillation energy from the adult paddle electrode to the pediatric paddle. This solid cadmium-silver button will not scratch the adult paddle electrode.

Note: Inspect the spring plates and the buttons routinely to make sure that they are clean and intact.

Attaching Pediatric Paddles

To attach the pediatric paddles, slide the paddles onto clean adult paddles, starting at the front of the adult paddle (see Figure 5-9).

Note: Do not use conductive gel *between* adult and pediatric paddles.

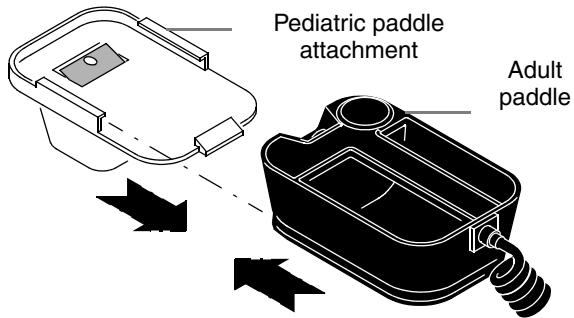

Figure 5-9 Attaching a Pediatric Paddle

Removing Pediatric Paddles

To remove the pediatric paddles:

- 1 Press down on the rear tab.
- 2 Slide the pediatric paddle off (see Figure 5-10).

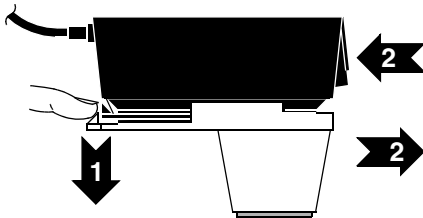

Figure 5-10 Removing a Pediatric Paddle

Paddle Placement

Adult paddles are recommended if the paddles will fit completely on the child's chest. Allow at least 1 inch of space between the paddles.

For neonates with very small chests, pediatric paddles may be too large to place in the anterior-lateral position. In this situation, place paddles in the anterior-posterior position. Holding the paddles against the chest and back will support the patient on his/her side.

Do not use the pediatric paddles on adults or older children. Delivery of recommended adult energies through this relatively small electrode surface increases the possibility of skin burns.

Anterior-Lateral

The following is the standard pediatric paddle placement (see Figure 5-11):

- STERNUM paddle to the patient's right upper torso, lateral to the sternum and below the clavicle.
- APEX paddle lateral to the patient's left nipple in the midaxillary line, with the center of the paddle in the midaxillary line if possible.

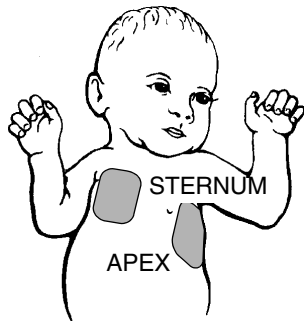

Figure 5-11 Anterior-lateral Paddle Position

Anterior-Posterior

Place the **STERNUM** paddle anteriorly over the left precordium and the **APEX** paddle posteriorly behind the heart in the infrascapular area (see Figure 5-12).

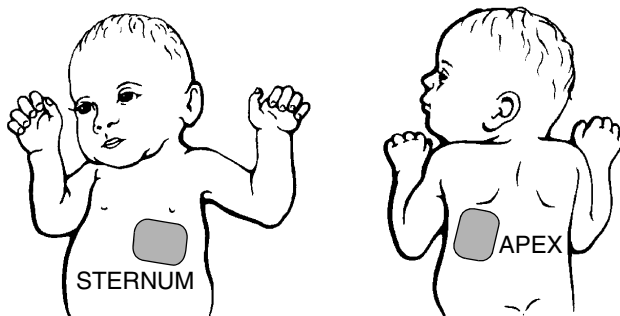

Figure 5-12 Anterior-posterior Paddle Position

Defibrillation Procedure

To defibrillate the patient:

- 1 Press **ON** to turn on the defibrillator.
- 2 Slide the pediatric paddles onto clean adult paddles. A click will be heard when fully engaged.
- 3 Apply defibrillation gel to the pediatric paddle electrode surfaces.
- 4 Select the appropriate energy for the weight of the child according to American Heart Association recommendations (or equivalent guidelines).
- 5 Place the paddles firmly on the patient's chest.
- 6 Press **CHARGE**.
- 7 Make certain all personnel, including the operator, are clear of the patient, the bed, and any equipment connected to the patient.
- 8 Discharge the defibrillator when it reaches full charge by pressing both discharge buttons simultaneously on the adult hard paddles. The defibrillator does not discharge until it completes charging to the selected energy level. If the discharge buttons are not pressed within 60 seconds, stored energy is removed automatically.
- 9 To remove an unwanted charge, press **SELECTOR**.
- 10 Observe the patient and the ECG rhythm. If an additional shock is necessary, repeat Step 4 through Step 10 of this procedure.

Note: (BIPHASIC DEFIBRILLATOR ONLY): If **ABNORMAL ENERGY DELIVERY** message appears and shock is not effective, repeat shock or increase energy and repeat shock. (See also page 4-18.)

Cleaning

Individually protect paddles before and after cleaning to prevent damage to paddle surfaces. After each use:

- 1 Wipe or rinse paddle electrodes, cable connector, paddle handles, and cables with mild soap and water or disinfectant using a damp sponge, towel or brush. Do not immerse or soak.
- 2 Dry thoroughly.
- 3 Examine paddle surfaces, handles, cables, and connector for damage or signs of wear. Cables showing signs of wear such as loose cable connections, exposed wires, or cable connector corrosion should be removed from use immediately. Paddles with rough and/or pitted electrodes should be removed from use immediately.

STERILIZABLE INTERNAL DEFIBRILLATION PADDLES

Physio-Control internal paddles are specifically designed for open chest cardiac defibrillation.

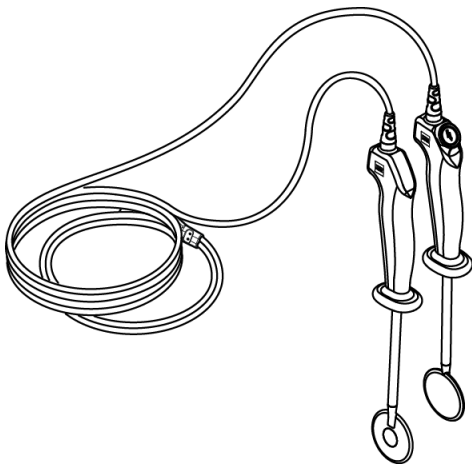

Figure 5-13 Sterilizable Internal Defibrillation Paddles

Internal paddles are available in several sizes. To order internal paddles, contact your Physio-Control representative or order online at store.physio-control.com (U.S. only).

For complete information about using internal paddles to provide open chest cardiac defibrillation, see the *Instructions for Use* provided with the internal paddles.

DATA MANAGEMENT

This section describes data management functions.

Overview of Data Storage and Retrieval	page 6-2
CODE SUMMARY Report	6-3
Managing Current Patient Records	6-7
Transmitting a Current Patient Report	6-7
Printing a Current Patient Report	6-9
Managing Archived Patient Records	6-11
Transmitting Archived Patient Reports	6-11
Printing Archived Patient Reports	6-15
Editing Archived Patient Records	6-17
Deleting Archived Patient Records	6-17
Overview of Connections for Transmitting Reports	6-20
Equipment Connections for Internal Modem – Analog Cellular	6-20
Equipment Connections for Internal Modem – Analog Landline	6-22
Equipment Connections for External Modem – Analog Landline	6-23
Equipment Connections for Direct Connect	6-24
Treatment Protocol When Transmitting Data or Fax	6-24
Fax Report Format	6-25
Troubleshooting Tips for Data Management	6-26

OVERVIEW OF DATA STORAGE AND RETRIEVAL

The following paragraphs describe how you can store and retrieve patient data using the LIFEPAK 12 defibrillator/monitor.

Data Storage

When you turn on the LIFEPAK 12 defibrillator/monitor, you create a new Patient Record stamped with the current date and time. All events and associated waveforms are digitally stored in the Patient Record as patient reports, which you can transmit or print. When you turn off the device, the current Patient Record data is saved in the patient archives.

To access the patient archives, press **OPTIONS** and select **ARCHIVES**. You can transmit, print, or delete any patient reports stored in the archived Patient Record. When you enter the archives mode, patient monitoring ends, and the current Patient Record is saved and closed. Turn off the device to exit the archives mode.

Report Types

Patient reports within a Patient Record are stored as one of the following report types:

- **CODE SUMMARY™ Critical Event Record** — Includes patient information, event and vital signs log, and waveforms associated with events (for example, defibrillation) as described on page 6-3.
- **12-Lead ECG Report** — The diagnostic 12-lead ECG report described in Section 3.
- **Continuous ECG Report** — Provides real-time single lead ECG data, acquired when the device is powered on and electrodes are connected to the patient.
- **Vital Signs Summary** — Includes patient information, event and vital sign log.
- **Snapshot Report** — Includes patient information and 8 seconds of waveform data captured at the time of transmission.
- **Trend Summary** — Includes patient information, vital sign log, and vital sign graphs.

Memory Capacity

The LIFEPAK 12 defibrillator/monitor retains data for two or more patients when you switch power off or remove the batteries. The number of patient reports that the LIFEPAK 12 defibrillator/monitor can store depends on various factors, including the number of displayed waveforms, the duration of each use, and the type of therapy. Typically, memory capacity includes up to 100 single waveform reports and 45 minutes of continuous ECG. When the defibrillator reaches the limits of its memory capacity, the defibrillator deletes an entire Patient Record using a “first in, first out” priority to accommodate a new Patient Record. Deleted Patient Records cannot be retrieved.

Report Retrieval

Table 6-1 shows which reports can be retrieved for printing or transmitting to a remote location. Transmitted reports must be received by one of the following:

- **Fax** – A Group III, Class 2 or 2.0 fax host
- **Data** – LIFENET® RS receiving station and CODE-STAT™ Suite data management system

Table 6-1 Report Retrieval Methods

Report Type	Print	Transmit – Fax	Transmit – Data
CODE SUMMARY	Yes	No	Yes
12-lead	Yes	Yes	Yes*
Continuous ECG	No	No	Yes
Vital Signs Summary	Yes	Yes	Yes
Snapshot	No	Yes	Yes
Trend Summary	Yes	No	Yes

* Data transmission of 12-lead ECGs will automatically include data transmission of the VS Summary.

CODE SUMMARY REPORT

The LIFEPAK 12 defibrillator/monitor automatically stores a CODE SUMMARY report as part of the Patient Record for each patient that consists of the following:

- Preamble
- Event/vital signs log

Figure 6-1 is an example of a CODE SUMMARY report. Press **CODE SUMMARY** to print the report.

Preamble	Event/Vital Signs Log
Name:CLAYTON, JOHN	TimeEventHRSpO2•PR
ID:041498060312	07:15:34Power On
Patient ID:	07:18:24Initial Rhythm9599•95
Incident:A980405335	07:20:34Vital Signs9887•98
Age: 45Sex: M	07:23:31Pacing 1 Started9598•95
CODE SUMMARY™	07:24:36Pacing 2 Set9399•93
Critical Event Record	07:25:10Intubation10096•100
Power On:06:03:12	07:25:34Vital Signs9698•96
Device:1234	07:27:04Pacing 3 Stopped9198•91
Site:ABCD	07:29:20Alarm HR16198•160
Total Shocks:3	07:30:34Vital Signs >1509698•96
Total Time Paced: 00:15:00	07:31:18Adenosine8897•88
Total 12-Leads:6	07:32:22Check Patient8896•88
Elapsed Time:00:52:43	07:33:11Shock 1 200J--96
COMMENTS:	07:33:59Shock 2 200J--96
	07:35:11Shock 3 360J--96
	07:35:34Vital Signs3598•35
	07:36:11Shock 4 Not Delivered7096•70
	07:40:34Transmit Harborview7298•72
1234 ABCD 3011371-XXX	0004KROKG4G07R LP12961404

Figure 6-1 CODE SUMMARY report (100 mm)

Preamble

The preamble consists of patient information (name, patient ID, age, and sex) and device information (date, time, and therapy information) as shown in Figure 6-1. The defibrillator automatically enters a unique identifier in the ID field for each Patient Record. This identifier is composed of the date and time that the defibrillator is turned on. The Incident field allows you to enter up to 14 alpha-numeric characters to link the device to other documents such as an EMS Run Report.

Event/Vital Signs Log

The LIFEPAK 12 defibrillator/monitor documents events and vital signs in chronological order. Events are operator or device actions that are related to monitoring, pacing, AED therapy, data transmission, and more. Table 6-2 shows a complete listing of events that can be found in the event log.

Vital signs (or active parameters) are entered into the log automatically every 5 minutes (or for each event; see AUTO LOG in Table 9-1) and when alarm limits are exceeded.

Table 6-2 Event Types

Event Types	Events																		
Monitoring	<ul style="list-style-type: none"> Initial rhythm Replace battery 	<ul style="list-style-type: none"> 12-lead NIBP 	<ul style="list-style-type: none"> Alarm events IP label change 	<ul style="list-style-type: none"> Vital signs 5-wire On/Off 															
Operator initiated	<ul style="list-style-type: none"> Event Alarms On/Off 	<ul style="list-style-type: none"> Print VF/VT Alarm On/Off 	<ul style="list-style-type: none"> Sync On/Off Snapshot 	<ul style="list-style-type: none"> Internal Pacer Detection On/Off 															
Transmission*	<ul style="list-style-type: none"> Transmission Complete No Dial Tone Transmission Failed 	<ul style="list-style-type: none"> Modem Initialization Error Busy Transmission Cancelled 	<ul style="list-style-type: none"> No Modem Found Unable To Connect 	<ul style="list-style-type: none"> Call Not Completed Lost Connection 															
Therapy	<table border="0"> <tr> <td style="padding-right: 10px;">AED</td> <td> <ul style="list-style-type: none"> Advisory mode Check patient </td> <td> <ul style="list-style-type: none"> Connect electrodes Motion </td> <td> <ul style="list-style-type: none"> Analysis Analysis stopped </td> <td> <ul style="list-style-type: none"> Shock advised No shock advised </td> </tr> <tr> <td style="padding-right: 10px;">Defibrillation</td> <td> <ul style="list-style-type: none"> Manual mode </td> <td> <ul style="list-style-type: none"> Charge removed </td> <td> <ul style="list-style-type: none"> Shock X Delivered </td> <td> <ul style="list-style-type: none"> Shock X Not Delivered </td> </tr> <tr> <td style="padding-right: 10px;">Pacing</td> <td> <ul style="list-style-type: none"> Started Paused </td> <td> <ul style="list-style-type: none"> Set </td> <td> <ul style="list-style-type: none"> Changed </td> <td> <ul style="list-style-type: none"> Stopped </td> </tr> </table>				AED	<ul style="list-style-type: none"> Advisory mode Check patient 	<ul style="list-style-type: none"> Connect electrodes Motion 	<ul style="list-style-type: none"> Analysis Analysis stopped 	<ul style="list-style-type: none"> Shock advised No shock advised 	Defibrillation	<ul style="list-style-type: none"> Manual mode 	<ul style="list-style-type: none"> Charge removed 	<ul style="list-style-type: none"> Shock X Delivered 	<ul style="list-style-type: none"> Shock X Not Delivered 	Pacing	<ul style="list-style-type: none"> Started Paused 	<ul style="list-style-type: none"> Set 	<ul style="list-style-type: none"> Changed 	<ul style="list-style-type: none"> Stopped
AED	<ul style="list-style-type: none"> Advisory mode Check patient 	<ul style="list-style-type: none"> Connect electrodes Motion 	<ul style="list-style-type: none"> Analysis Analysis stopped 	<ul style="list-style-type: none"> Shock advised No shock advised 															
Defibrillation	<ul style="list-style-type: none"> Manual mode 	<ul style="list-style-type: none"> Charge removed 	<ul style="list-style-type: none"> Shock X Delivered 	<ul style="list-style-type: none"> Shock X Not Delivered 															
Pacing	<ul style="list-style-type: none"> Started Paused 	<ul style="list-style-type: none"> Set 	<ul style="list-style-type: none"> Changed 	<ul style="list-style-type: none"> Stopped 															
Memory Status	<ul style="list-style-type: none"> Out of Waveform Memory [memory low] 	<ul style="list-style-type: none"> Out of Event Memory [memory full] 																	

* Unsuccessful transmission events include an identification code, for example, Modem Initialization Error 103. Refer to Table 6-5 for additional information on transmission error codes.

Waveform Events

In addition to being documented in the Event Log, therapy and other selected events also capture waveform data as described in Table 6-3.

Table 6-3 Waveform Events

Event Name	Waveform Data
INITIAL RHYTHM	• 8 seconds after leads on.
CHECK PATIENT	• 8 seconds prior to alert.
SHOCK or NO SHOCK ADVISED	• 2-3 segments of analyzed ECG. Each segment is 2.7 seconds.
ANALYSIS X STOPPED	• 8 seconds of data prior to cessation of analysis.
SHOCK X	• 3 seconds prior to shock and 5 seconds after shock.
PACING X STARTED	• 8 seconds prior to increase of current from 0.
PACING X SET	• 8 seconds after ppm and mA are stable for 10 seconds.
PACING X CHANGED	• 8 seconds after pacing rate, current, or mode is changed.
PACING X STOPPED	• 3 seconds prior to pacing current is zero and 5 seconds after.
PACING X PAUSED	• Initial 8 seconds while PAUSE is pressed.
ALARM*	• 3 seconds prior to violated parameter and 5 seconds after.
EVENT*	• 3 seconds prior to event selection and 5 seconds after.
PRINT	• 3 seconds prior to pressing PRINT and 5 seconds after.
12-LEAD	• 12-lead ECG data.
SNAPSHOT	• 3 seconds prior to and 5 seconds after SNAPSHOT requested.
VITAL SIGNS	• 3 seconds prior to and 5 seconds after vital signs are acquired.

* To reduce the length of the CODE SUMMARY report, storing waveform data with these events can be configured OFF (see page 9-10).

Waveforms are preceded by a header that includes the following information:

- Patient data
- Event name
- Therapy data*
- Vital signs
- Device configuration information

* Patient impedance (in ohms) appears on shock reports from biphasic defibrillators (100 mm printer) using disposable defibrillation electrodes. This impedance is measured just prior to the shock and is used to determine voltage compensation.

CODE SUMMARY Format

You can configure the LIFEPAK 12 defibrillator/monitor to print a CODE SUMMARY report in one of the formats described in Table 6-4. When CODE SUMMARY reports are transmitted, they are always sent in the Long format.

Table 6-4 CODE SUMMARY Formats

Format	Attributes
Long format	<ul style="list-style-type: none"> • Preamble • Event/vital signs log • Event waveforms • 12-lead ECG report(s)
Medium format	<ul style="list-style-type: none"> • Preamble • Event/vital signs log • Event waveforms
Short format	<ul style="list-style-type: none"> • Preamble • Event/vital signs log

The configured format determines only which reports are printed when the **CODE SUMMARY** button is pressed. The 12-lead ECG reports are always accessible as individual reports. If you interrupt printing of a **CODE SUMMARY** report, this results in the reprinting of the entire **CODE SUMMARY** report when printing is resumed.

CODE SUMMARY COMPLETE is printed immediately following the last waveform event.

See Figure 6-2 for examples of waveform event printouts in the **CODE SUMMARY** report.

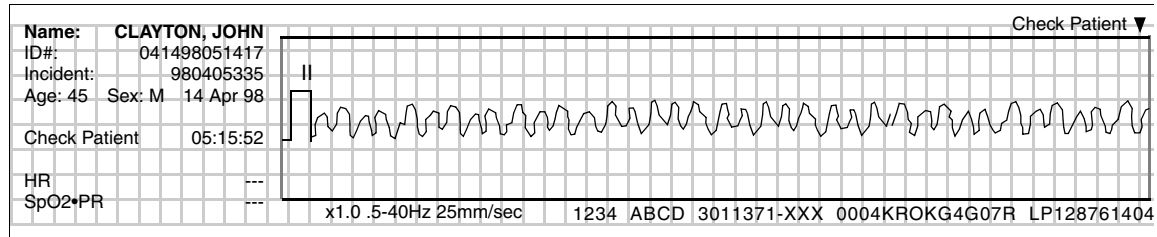

Check Patient Report (CPSS)

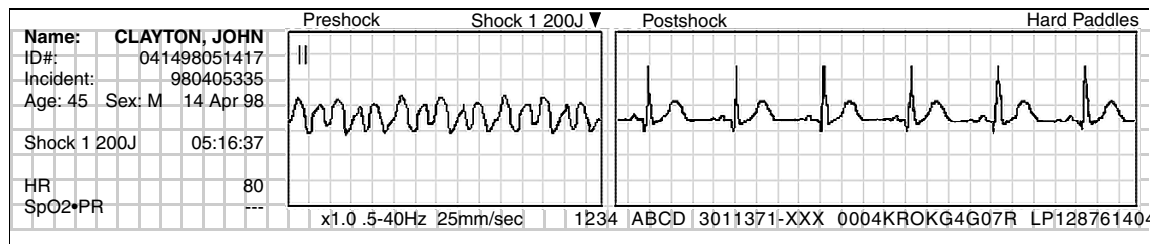

Shock Report

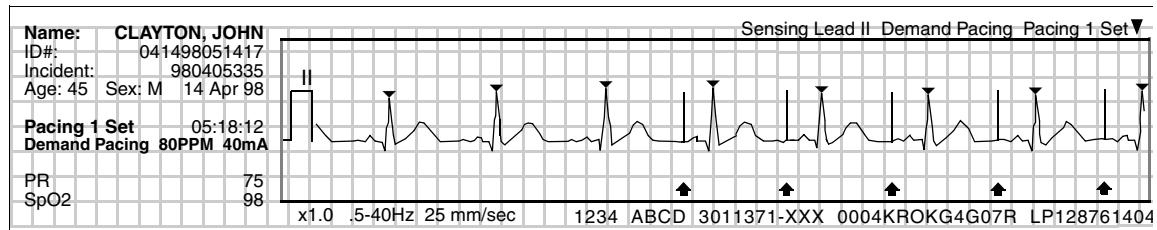

Pacing Report

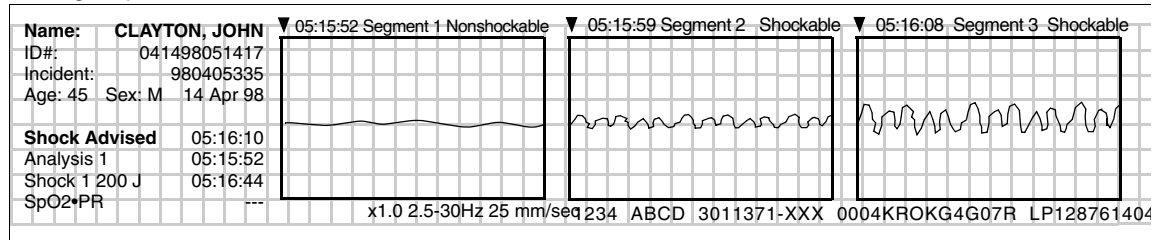

Analysis Report (SAS)

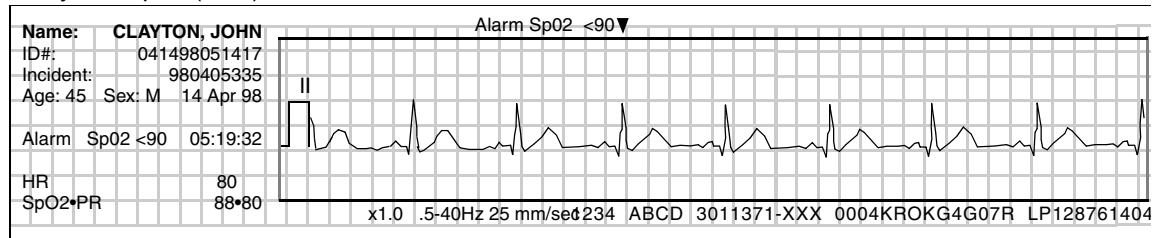

Alarm Report

Figure 6-2 Waveform Event Printout Examples (50 mm)

MANAGING CURRENT PATIENT RECORDS

When you turn on the LIFEPAK 12 defibrillator/monitor, you create a new Patient Record stamped with the current date and time. Each patient report in the Patient Record includes this information, for example, ID:041498132145. To add specific patient information, see "Entering Patient Data" on page 2-20.

There are two options for managing the current Patient Record:

- Transmitting current patient reports
- Printing current patient reports

TRANSMITTING A CURRENT PATIENT REPORT

Refer to Table 6-1 for a summary of retrieval options for transmitted patient reports. The following procedure uses TRANSMIT / DATA as an example. TRANSMIT / FAX, if installed, is similar in operation; however, only 12-lead ECG, Snapshot, and Vital Signs reports are available for transmission to a fax host.

To transmit:

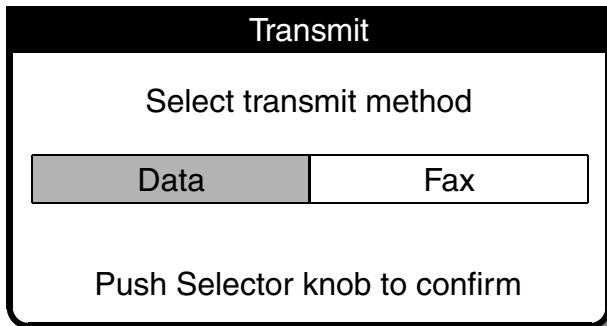

- 1 Press TRANSMIT to display the Transmit overlay.
- 2 For a data transmission, select DATA. For a fax transmission, select FAX.

Note: Only devices with the fax option installed will display this screen.

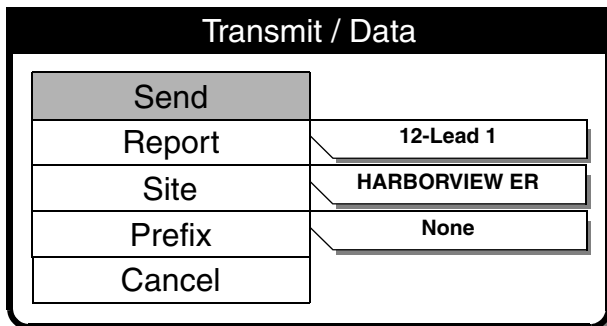

- 3 If the REPORT, SITE, and PREFIX settings are correct, select SEND to transmit.

Otherwise, proceed to Step 4 through Step 6.

Note: With SITE set to NONE, you can send data (or fax) to any data receiving station (or fax machine) by entering the phone number in the prefix field.

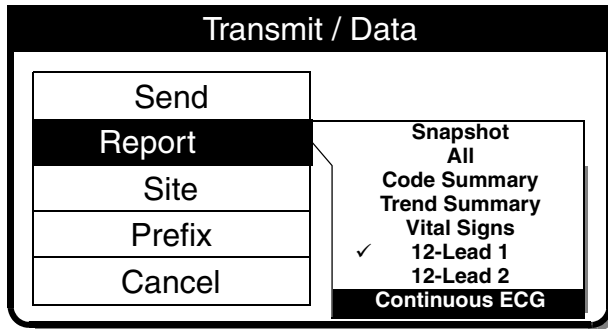

- 4 Select **REPORT** to display the report list. Choose the desired report:
 SNAPSHOT – Sends the Snapshot report.
 ALL – Sends all reports on the list.
 CODE SUMMARY – Sends the Critical Event report.
 TREND SUMMARY – Sends the Trend Summary report.
 VITAL SIGNS – Sends the Vital Signs report.
 12-LEAD – Sends the selected 12-Lead report.
 CONTINUOUS ECG – Sends the Continuous ECG report.
 A check mark indicates a report already sent successfully.

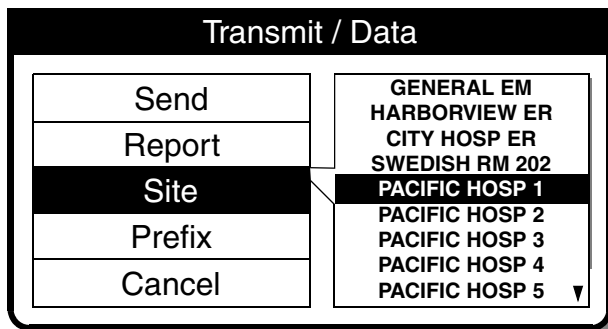

- 5 Select **SITE** to choose a transmit site from the list of configured sites.
 Up/down arrows (▲▼) indicate more site listings (up to 19 sites).
 If **NONE** is displayed, no sites are set up. Refer to "Setting Up Transmit Sites" on page 9-19.

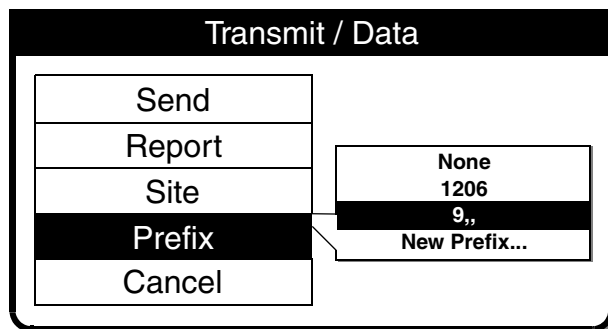

- 6 Select **PREFIX** to choose a telephone prefix for the transmit site location, or leave as **NONE**.
 To enter a new prefix (for this transmission only) select **NEW PREFIX**.

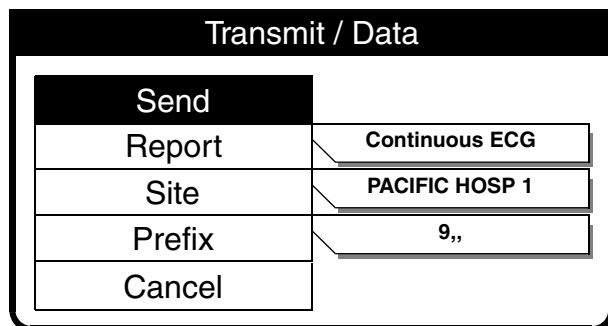

- 7 Select **SEND** to transmit. A series of messages indicates the progress of your transmission.
 A transmission report will print documenting success or failure of the transmission.
 See the troubleshooting information in Table 6-5 if the report is not transmitted.

Transmit / Data	
Send	
Report	Continuous ECG
Site	PACIFIC HOSP 1
Prefix	9,,
Cancel	

8 Select **CANCEL** to discontinue the transmit operation.

Transmit / Data / Cancel	
Cancel all transmissions?	
Yes	No
Push Selector knob to confirm	

9 Select **YES** to end a transmission. Select **NO** to return to the previous screen.

PRINTING A CURRENT PATIENT REPORT

To print:

Options	
Patient...	Archives...
Pacing...	Print...
Date/Time...	User Test
Alarm Volume...	

- 1 Press **OPTIONS**.
- 2 Select **PRINT**.

Options / Print	
Print	
Report	Code Summary
Format	3-Channel
Mode	Monitor
Speed	25 mm/sec

3 If the **REPORT**, **FORMAT**, and **MODE** settings are correct, select **PRINT** to print the current patient report. Otherwise, proceed to Step 4 through Step 7.

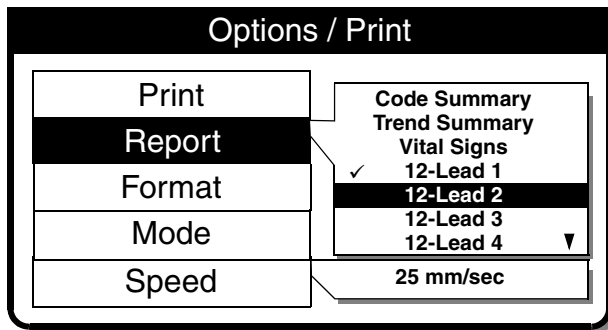

- 4 Select **REPORT** to choose from the list of reports:

CODE SUMMARY – Prints the Code Summary report.

TREND SUMMARY – Prints the Trend Summary report.

VITAL SIGNS – Prints the Vital Signs report.

12-LEAD – Prints the selected 12-Lead report. Reports previously printed display a check mark.

Up/down arrows (▲▼) indicate more selections on list.

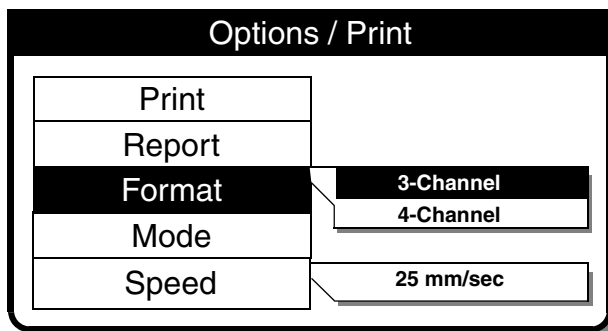

- 5 Select **FORMAT** (for 12-Lead ECG only) and choose the desired format for the 12-Lead report.

For more information about 3-Channel and 4-Channel formats, see Figure 3-7, Figure 3-8, Figure 3-9, and Figure 3-10.

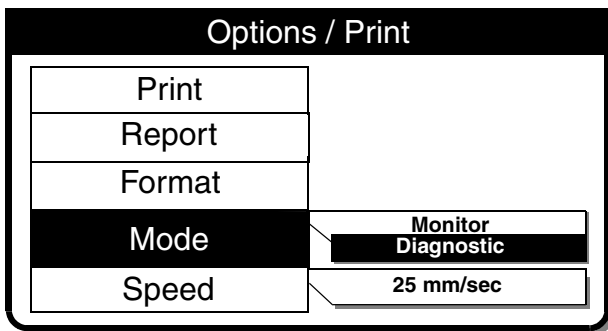

- 6 Select **MODE** to choose printer **MONITOR** or **DIAGNOSTIC** frequency response.

12-Lead reports are always printed in the **DIAGNOSTIC** mode.

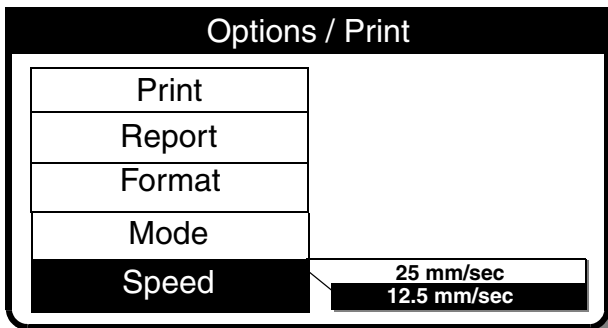

- 7 Select **SPEED** to choose the desired printer speed.

Options / Print	
Print	
Report	12-Lead 2
Format	3-Channel
Mode	Diagnostic
Speed	25 mm/sec

- 8 Select PRINT to print the current patient report.

MANAGING ARCHIVED PATIENT RECORDS

When you turn off the LIFEPAK 12 defibrillator/monitor, the current Patient Record is saved in the archives. There are four options for managing archived Patient Records:

- Transmit archived patient reports
- Print archived patient reports
- Edit archived patient information
- Delete archived Patient Records

Note: When you enter the archives mode, patient monitoring ends (for example, no ECG, no alarms) and the current Patient Record is saved and closed.

TRANSMITTING ARCHIVED PATIENT REPORTS

Refer to Table 6-1 for a summary of report retrieval options for data and fax transmissions. The following procedure uses OPTIONS / ARCHIVES / SEND DATA as an example. OPTIONS / ARCHIVES / SEND FAX is similar in operation.

To transmit:

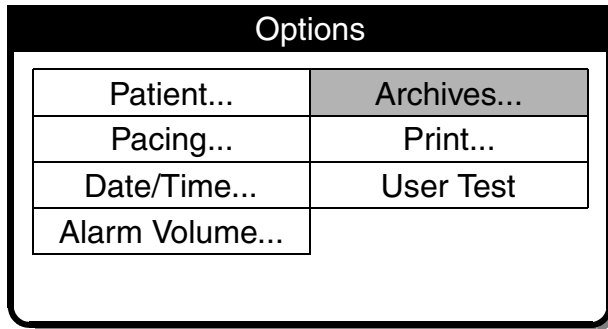

- 1 Press **OPTIONS**.
- 2 Select **ARCHIVES**.

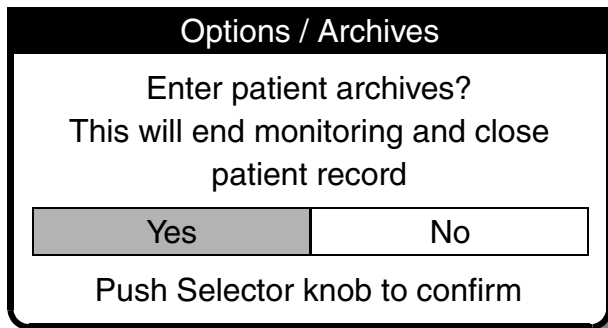

- 3 Select **YES** to enter the patient archives.
NO clears the overlay and returns to the previous screen.
YES closes and saves the current Patient Record and removes viewing of the monitoring screen.

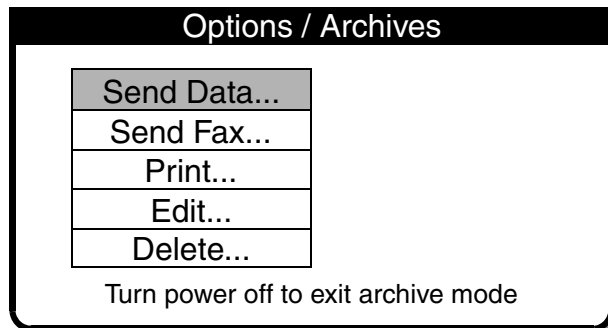

- 4 For data transmission to a compatible data station (refer to Table 6-1), select **SEND DATA**.
 For fax transmission to a fax host, select **SEND FAX**.
Note: Only devices with the fax option installed will show the **SEND FAX** selection.

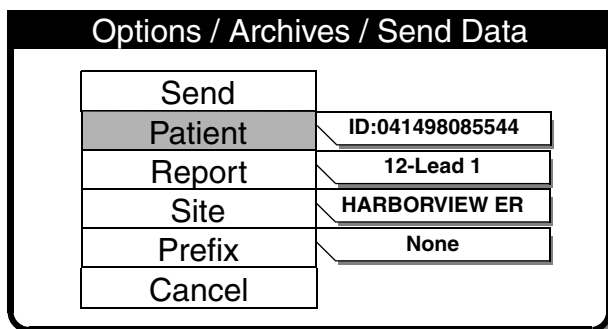

- 5 If the **PATIENT**, **REPORT**, **SITE**, and **PREFIX** settings are correct, select **SEND** to transmit. Otherwise, select **PATIENT** and proceed to Step 6 through Step 12.

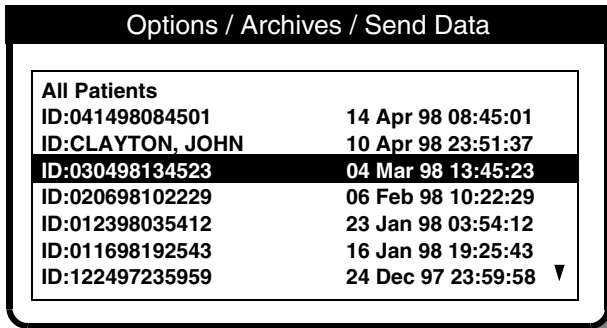

6 Choose from the list of Patient Records or select ALL PATIENTS to transmit all Patient Records stored in the archives.

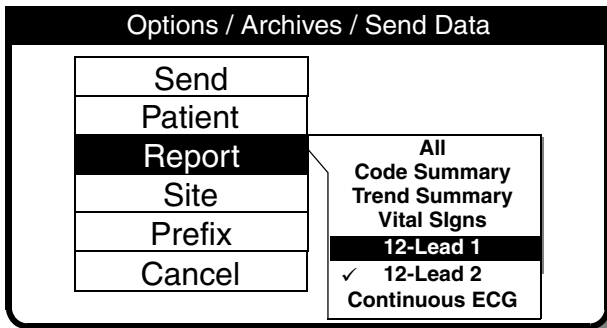

7 Select REPORT to display the report list:

- ALL – Sends all reports on the list
- CODE SUMMARY – Sends the Code Summary report
- TREND SUMMARY – Sends the Trend Summary report
- VITAL SIGNS – Sends the Vital Signs report
- 12-LEAD – Sends the selected 12-Lead report
- CONTINUOUS ECG – Sends the Continuous ECG report.

A check mark indicates a report was previously sent successfully.

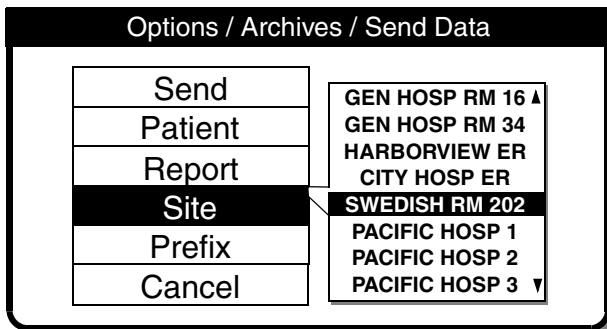

8 Select SITE to choose a transmit site from the list of configured sites.

Up/down arrows (▲▼) indicate more sites.

If NONE is displayed, no sites are set up. Refer to "Setting Up Transmit Sites" on page 9-19.

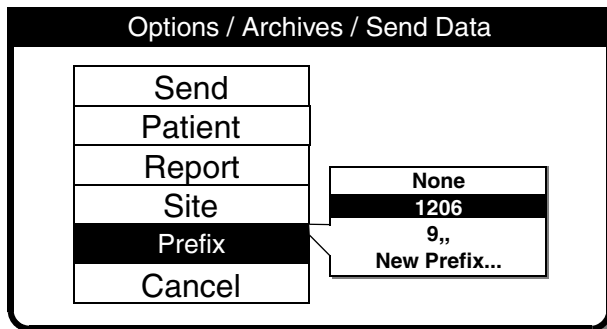

9 Select PREFIX to choose a telephone prefix for the transmit site location, or leave as NONE.

To enter a new prefix (for this transmission only) select NEW PREFIX.

Options / Archives / Send Data

Send	
Patient	ID:030498134523
Report	12-LEAD 1
Site	SWEDISH RM 202
Prefix	1206
Cancel	

10 Select **SEND** to transmit. A series of messages indicates the progress of your transmission.

A transmission report will print documenting success or failure of the transmission.

See the troubleshooting information in Table 6-5 if the report is not transmitted.

To return to the **OPTIONS / ARCHIVES** menu, press **HOME SCREEN**.

To exit the archives mode, turn off the device.

Options / Archives / Send Data

Send	
Patient	ID:030498134523
Report	12-LEAD 1
Site	SWEDISH RM 202
Prefix	1206
Cancel	

11 Select **CANCEL** to discontinue the transmit operation.

Options / Archives / Send Data / Cancel

Cancel all transmissions?

Yes	No
------------	----

Push Selector knob to confirm

12 Select **YES** to end the transmission session.

Select **NO** to return to the previous screen.

13 To exit the archives mode, turn off the device.

PRINTING ARCHIVED PATIENT REPORTS

To print:

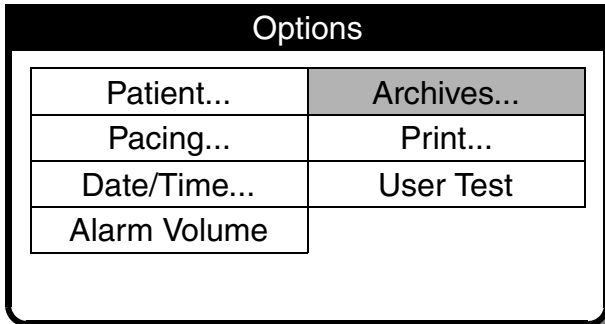

- 1 Press **OPTIONS**.
- 2 Select **ARCHIVES**.

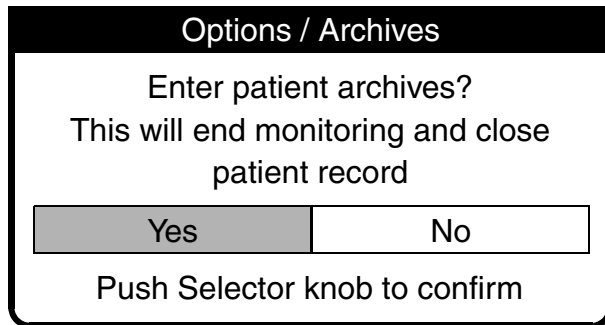

- 3 Select **YES** to enter the patient archives.

YES closes and saves the current Patient Record and removes viewing of the monitoring screen.

 Select **NO** to clear the overlay and return to the previous screen.

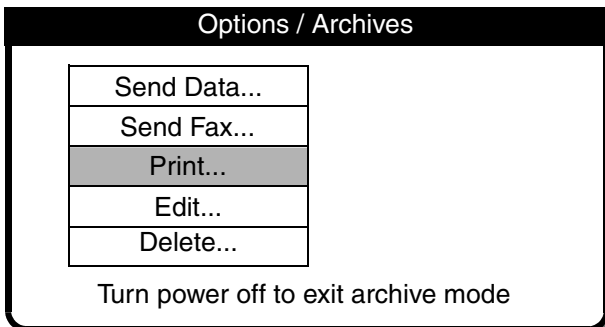

- 4 Select **PRINT**.

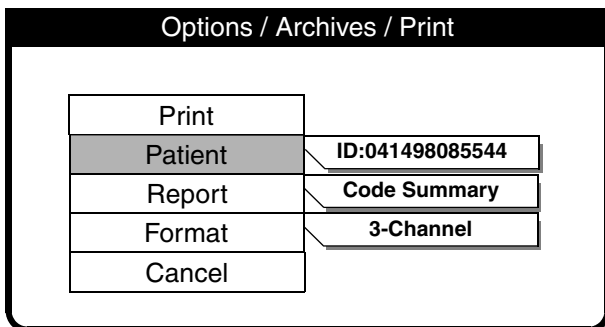

- 5 If the **PATIENT**, **REPORT**, and **FORMAT** settings are correct, select **PRINT** to print the report. Otherwise, select **PATIENT** and proceed to Step 6 through Step 9.

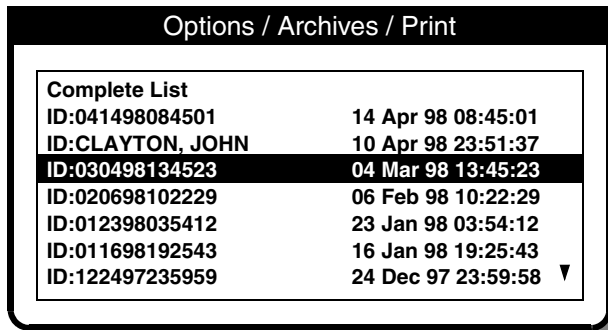

6 Choose from the list of Patient Records or select COMPLETE LIST to print a list of all Patient Records in the archives.

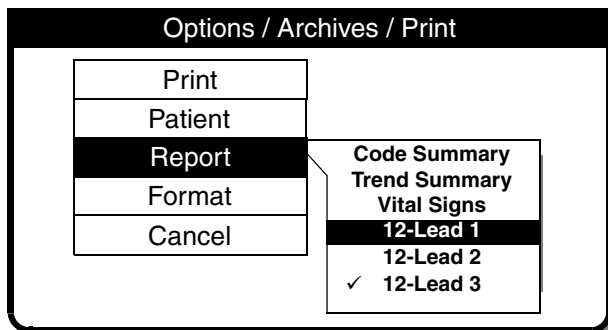

7 Select REPORT to display the report list:
 CODE SUMMARY – Prints the Code Summary report
 TREND SUMMARY – Prints the Trend Summary report
 VITAL SIGNS – Prints the Vital Signs report
 12-LEAD – Prints the selected 12-Lead report
 A check mark indicates a report previously printed.

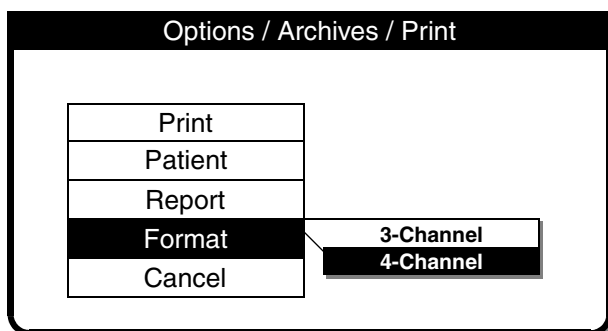

8 Select FORMAT (for 12-Lead ECG only) and choose the desired format for the 12-Lead report.
 For more information about 3-Channel and 4-Channel formats, see Figure 3-7, Figure 3-8, Figure 3-9, and Figure 3-10.

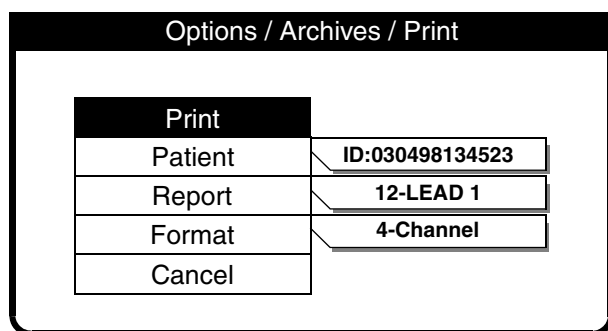

9 Select PRINT.
 10 To cancel printing, select CANCEL.
 To return to the OPTIONS / ARCHIVES Menu, press the HOME SCREEN control.
 To exit the archives mode, turn off the device.

EDITING ARCHIVED PATIENT RECORDS

To edit:

Options	
Patient...	Archives...
Pacing...	Print...
Date/Time...	User Test
Alarm Volume	

- 1 Press OPTIONS.
- 2 Select ARCHIVES.

Options / Archives	
Enter patient archives? This will end monitoring and close patient record	
Yes	No
Push Selector knob to confirm	

- 3 Select YES to enter the patient archives.
YES closes and saves the current Patient Record and removes viewing of the monitoring screen.

Select NO to clear the overlay and return to the previous screen.

Options / Archives	
Send Data...	
Send Fax...	
Print...	
Edit...	
Delete...	
Turn power off to exit archive mode	

- 4 Select EDIT.
Note: Only devices with the fax option installed will show the SEND FAX selection.

Options / Archives / Edit	
Patient	061500042159
Last Name	CLAYTON
First Name	JOHN
Patient ID	528660444
Incident	BF412
Age	46
Sex	MALE

- 5 Select PATIENT.
- 6 Add the necessary patient information. Only blank fields may be edited.
- 7 Press HOME SCREEN, then turn off the device.

DELETING ARCHIVED PATIENT RECORDS

To delete:

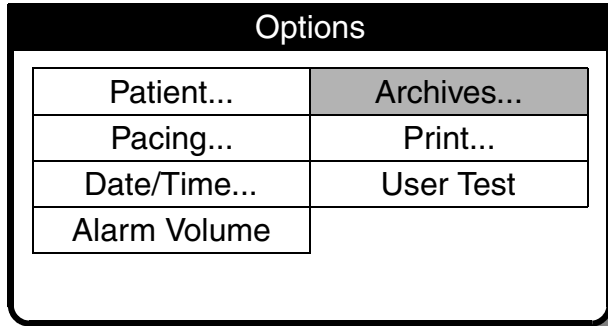

- 1 Press **OPTIONS**.
- 2 Select **ARCHIVES**.

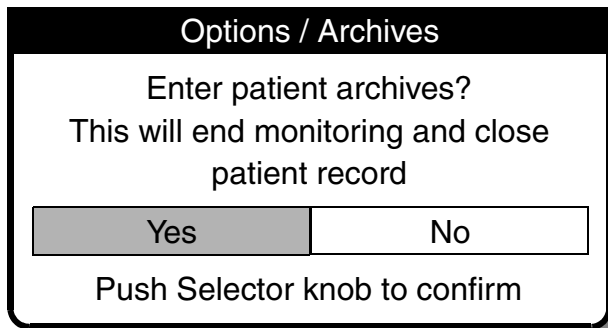

- 3 Select **YES** to enter the patient archives.
YES closes and saves the current Patient Record and removes viewing of the monitoring screen.

Select **NO** to clear the overlay and return to the previous screen.

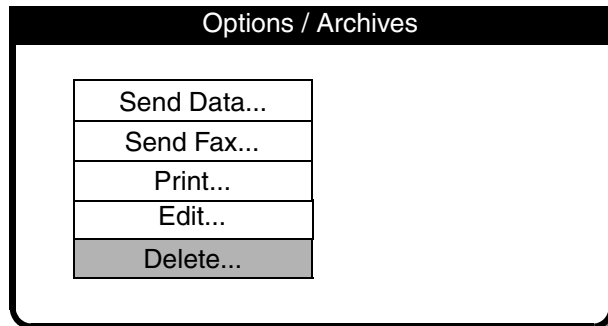

- 4 Select **DELETE**.
Note: Only devices with the fax option installed will show the **SEND FAX** selection.

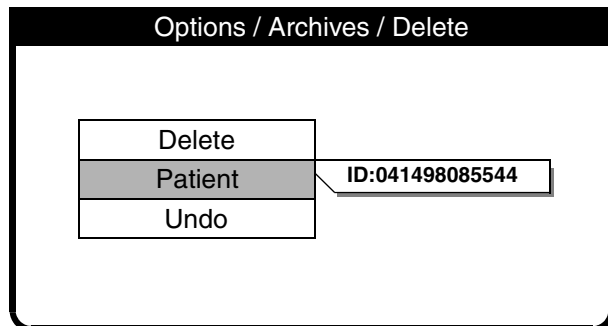

- 5 Select **PATIENT**.

Options / Archives / Delete	
ID:041498121632	12 Apr 98 12:16:32
ID:041498084501	14 Apr 98 08:45:01
ID:CLAYTON, JOHN	10 Apr 98 23:51:37
ID:030498134523	04 Mar 98 13:45:23
ID:020698102229	06 Feb 98 10:22:29
ID:012398035412	23 Jan 98 03:54:12
ID:011698192543	16 Jan 98 19:25:43
ID:122497235959	24 Dec 97 23:59:58

6 Choose from the list of the Patient Records.

Options / Archives / Delete	
Delete	
Patient	CLAYTON, JOHN
Undo	

7 Select DELETE to permanently remove the selected Patient Record from the archives.

Note: To undo the delete operation, immediately select UNDO. If you continue with other device operations, you will not be able to undo this delete.

8 Press HOME SCREEN, and then turn off the device.

OVERVIEW OF CONNECTIONS FOR TRANSMITTING REPORTS

For specific information and procedures concerning printing and transmitting patient reports, refer to "Managing Current Patient Records" on page 6-7 and "Managing Archived Patient Records" on page 6-11. Before patient data can be transmitted, the transmission sites must be configured. Refer to "Setting Up Transmit Sites" on page 9-19.

The LIFEPAK 12 defibrillator/monitor can transmit patient reports to a PC-compatible computer with CODE-STAT Suite installed, or to a Group III, Class 2 or 2.0 fax host. Refer to the LIFEPAK 12 Accessory Catalog or contact your Physio-Control representative for information about the CODE-STAT Suite version that is compatible with your LIFEPAK 12 defibrillator/monitor.

You can transmit data or fax through the PC Card™ modem, or data through the System Connector located on the back of the LIFEPAK 12 defibrillator/monitor. To transmit patient data, the PC Card modem or external modem must be AT-command set compatible (TIA/EIA 602). Contact your local Physio-Control representative for up-to-date information on compatible modem brands and part numbers.

The capacity to transmit patient data using telecommunications may not be available in all countries. Contact your local Physio-Control representative for more information.

The device is set up to transmit patient reports using one of the following transmit methods:

- **Internal Cell** Transmit reports by analog cellular telephone using an internal PC Card modem. Requires the following for interconnection (see Figure 6-3):
 - PC Card Modem
 - Modem Door (replaces the PC Card cover) PN 3011422
- **Internal** Transmit reports by analog landline telephone using an internal PC Card modem. Requires the following for interconnection (see Figure 6-4):
 - PC Card Modem
 - Standard Telephone Cable (supplied with the PC Card Modem)
 - Modem Door (replaces the PC Card cover) PN 3011422
- **External** Transmit reports by analog landline telephone using an external modem. Requires the following for interconnection (see Figure 6-5):
 - External Modem
 - External Modem Adapter Cable PN 3010727-00 (6 feet) or PN 3010727-01 (10 feet)
 - Standard Telephone Cable (supplied with the External Modem)
- **External Cell** Used for special situations, such as certain digital phones. For more information, contact your local Physio-Control representative or consult the Datacomm support page on our web site, (www.physio-control.com).
- **Direct Connect** Send reports by serial data cable to a PC-compatible computer with CODE-STAT Suite installed. Requires the following for interconnection (see Figure 6-6):
 - Serial Port Interface Cable PN 3009817-00

CAUTION!

Potential equipment damage.

Damage to the serial port interface cable may result if you move the device with the cable attached. Unplug the cable from the port before moving the device.

EQUIPMENT CONNECTIONS FOR INTERNAL MODEM – ANALOG CELLULAR

Figure 6-3 shows you the equipment connection method for transmitting reports by analog cellular telephone using an internal PC Card modem. If you want to use an analog cellular telephone other than the recommended Motorola model, contact your Physio-Control sales or service representative to confirm compatibility. For international equipment connections, see Appendix F.

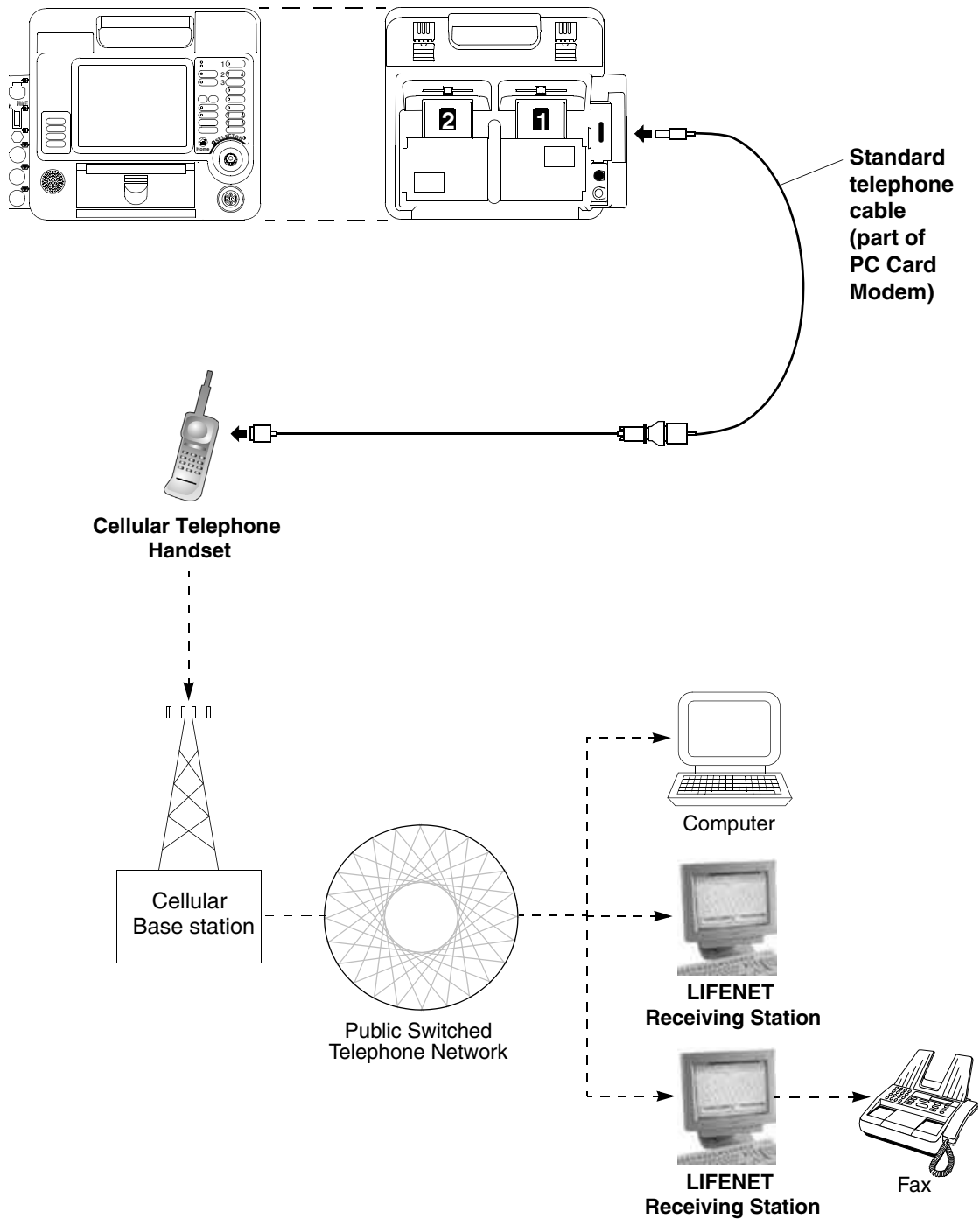

Figure 6-3 Equipment Connections for Internal Modem – Analog Cellular

EQUIPMENT CONNECTIONS FOR INTERNAL MODEM – ANALOG LANDLINE

Figure 6-4 shows you the equipment connections for transmitting reports by analog landline telephone using an internal PC Card modem.

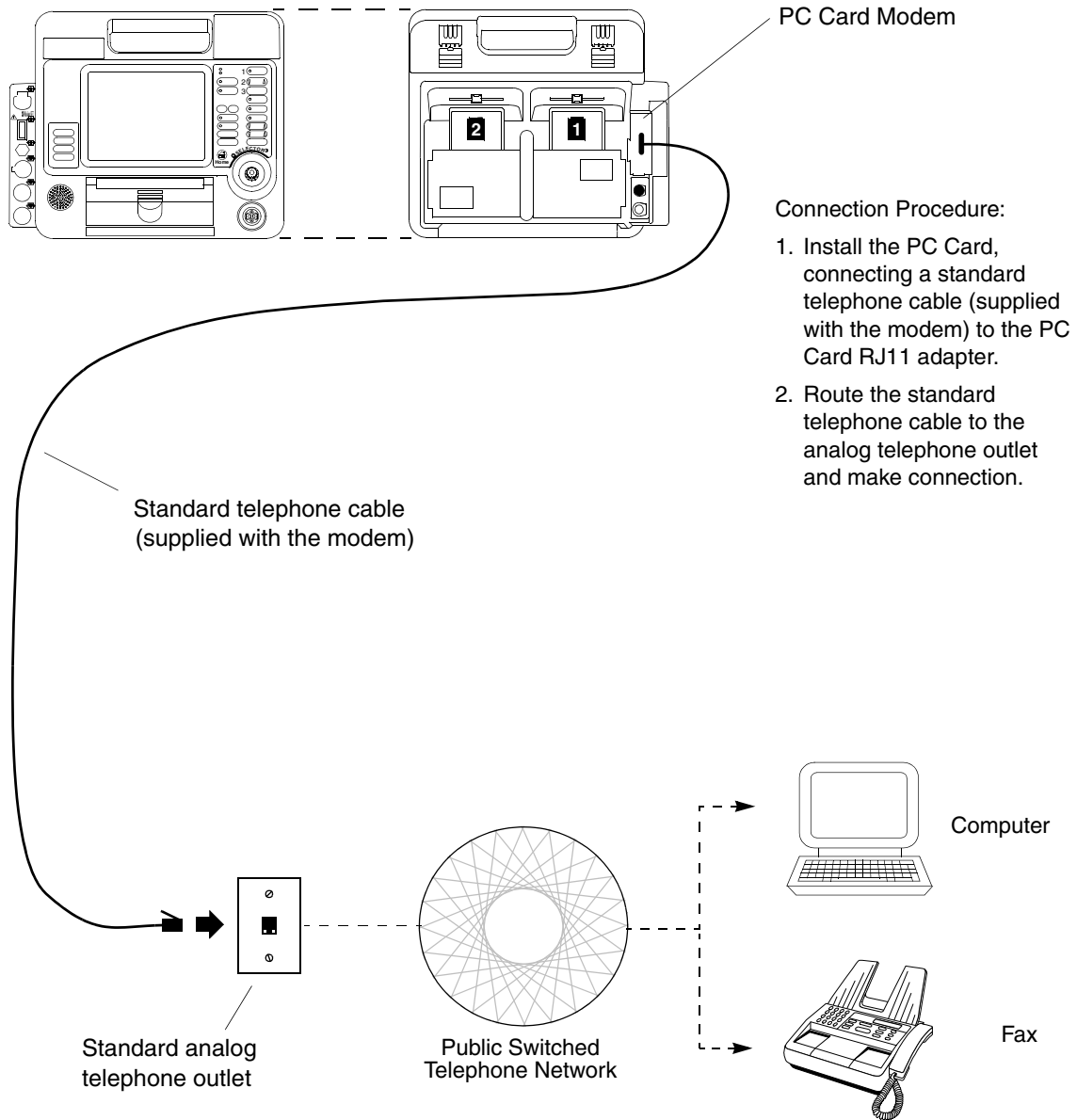

Figure 6-4 Equipment Connections for Internal Modem – Analog Landline

EQUIPMENT CONNECTIONS FOR EXTERNAL MODEM – ANALOG LANDLINE

Figure 6-5 shows you the equipment connections for transmitting reports by analog landline telephone using an external modem.

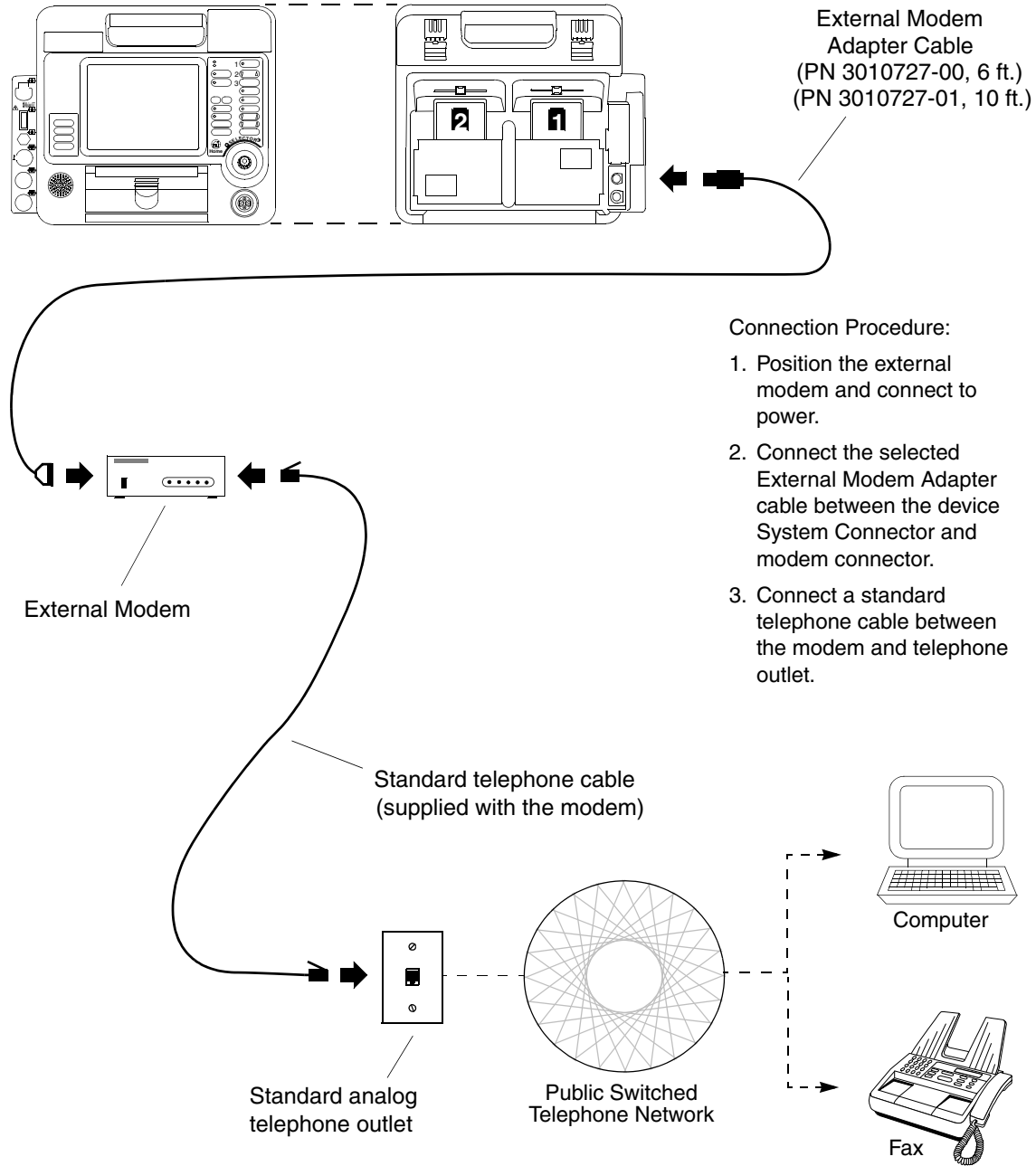

Figure 6-5 Equipment Connections External Modem – Analog Landline

EQUIPMENT CONNECTIONS FOR DIRECT CONNECT

Figure 6-6 shows you the equipment connections to send reports directly to a computer using a direct connection cable.

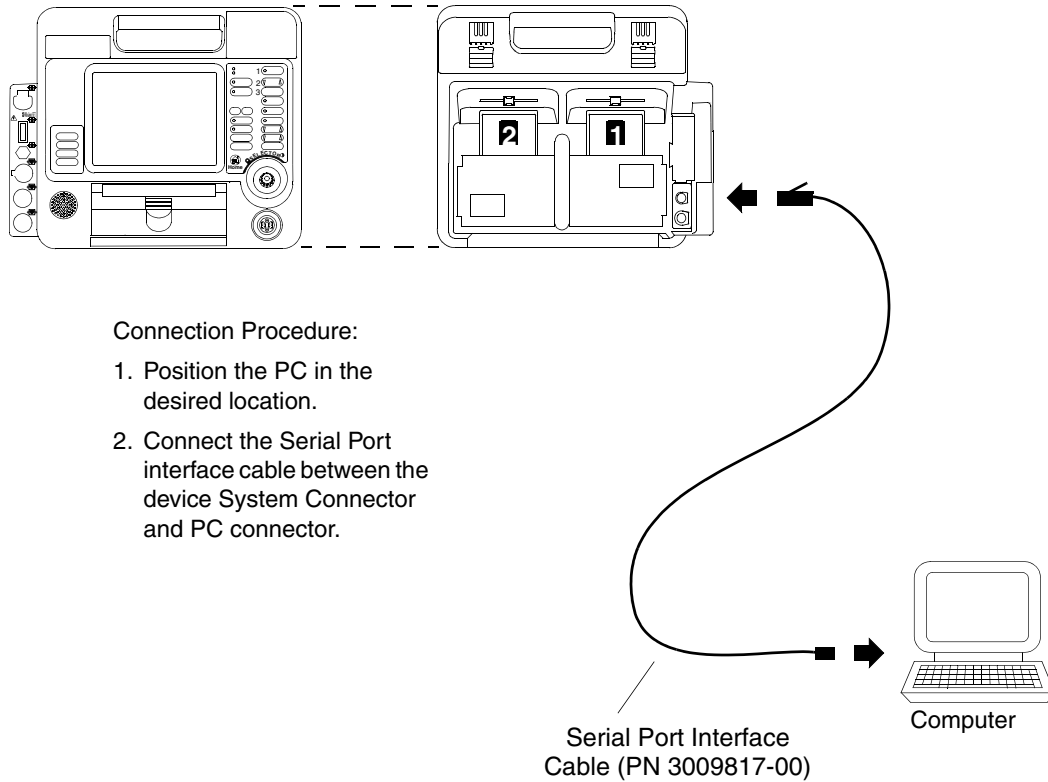

Figure 6-6 Equipment Connections – Direct Connect

TREATMENT PROTOCOL WHEN TRANSMITTING DATA OR FAX

When considering any treatment protocol that involves transmitting patient data or fax by telecommunications, you must be aware of possible limitations. Successful transmission depends on access to public or private network services that may or may not always be available. This is especially true for cellular communication, which is influenced by many factors, such as:

- Geography
- Location
- Weather
- The number of cellular service users

Treatment protocol must always take into account the fact that data or fax transmissions *cannot be assured* using landline or cellular communications. Your treatment protocol must include contingency planning for interrupted data transmission.

FAX REPORT FORMAT

Figure 6-7 shows the page format when you fax a current or archived 12-Lead ECG. The most widely available fax image resolutions, Normal and Fine, do not allow precise reproduction of ECG waveforms in diagnostic frequency response. For the best available viewing, Physio-Control recommends that 12-lead ECG reports be sent and received in Fine resolution, which meets American Association of Medical Instrumentation (AAMI) standards for transmitting ECGs by fax. Fax reports sent and received in Normal resolution have a poorer quality and may not be adequate for diagnostic purposes.

The fax resolution level is established at the time of connection and is determined by the capability of the fax host. Each fax report includes one of the following statements about resolution:

- **Faxed ECG: Fine Resolution.**
- **Faxed ECG: Normal Resolution. May not be adequate for diagnostic purposes.**

The following additional statement on the fax report advises using the grid lines printed on the fax for making waveform measurements, rather than using a separate measurement tool:

- Always use the grid lines printed on the fax copy when assessing ECGs.

Fax information header (see Table 9-29 for entering the Organization name and phone #)

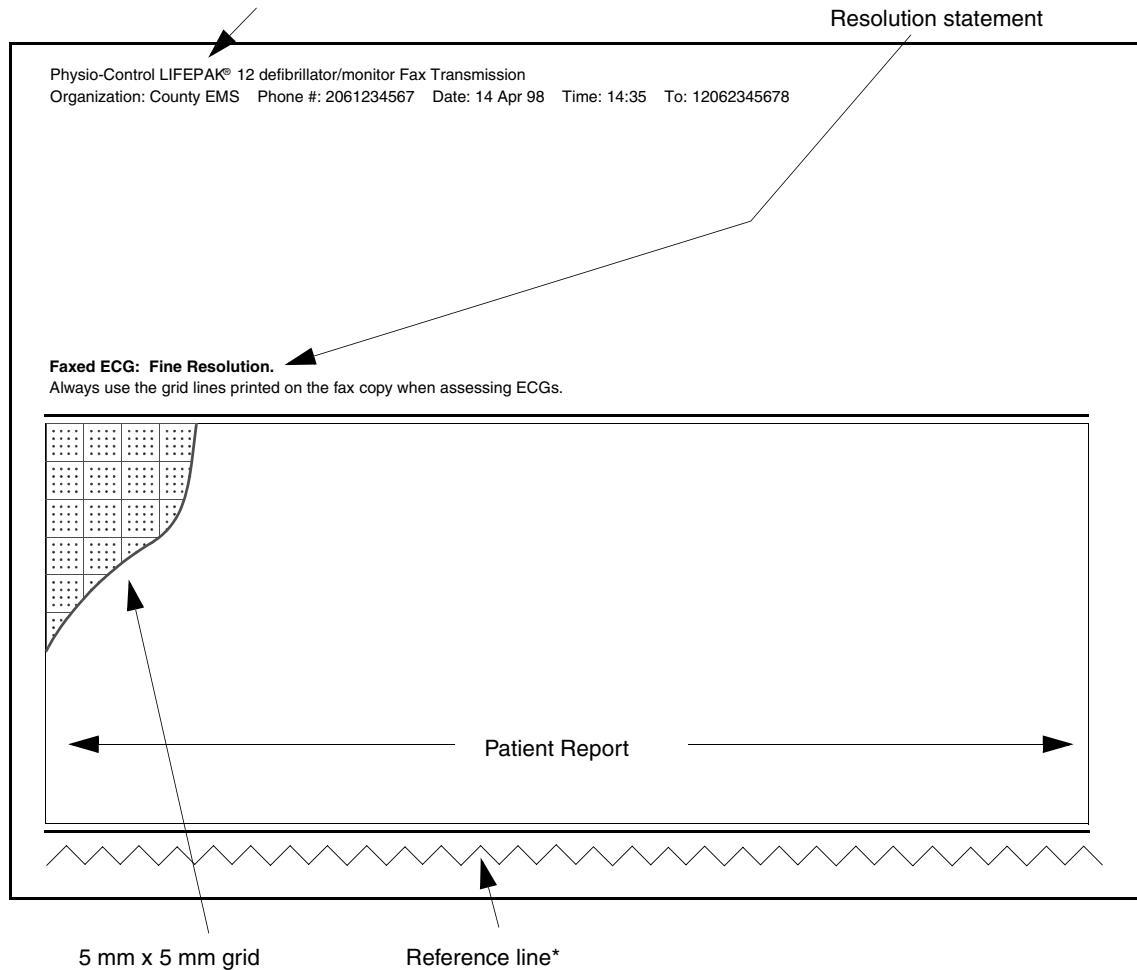

* Reference line should be continuous; breaks in the line indicate missing data.

Figure 6-7 Fax Report Format

TROUBLESHOOTING TIPS FOR DATA MANAGEMENT
Table 6-5 Troubleshooting Tips for Data Management

ID	Observation	Possible Cause	Corrective Action
100	MODEM INITIALIZATION ERROR message appears.	Unidentifiable modem initialization error.	<ul style="list-style-type: none"> • Check modem setup. • Check connections. • Verify a modem is installed/connected.
101	NO MODEM FOUND message appears.	Modem disconnected. Modem is not connected to an analog telephone line.	<ul style="list-style-type: none"> • Connect modem. • Confirm that the telephone line is analog (not digital).
102	MODEM INITIALIZATION ERROR message appears.	Modem initialization string is incorrect.	<ul style="list-style-type: none"> • Check Modem initialization string in Setup menu.
103	MODEM INITIALIZATION ERROR message appears.	Fax modem setup error.	<ul style="list-style-type: none"> • Check Modem initialization string in Setup menu.
104	MODEM INITIALIZATION ERROR message appears.	Fax modem failed to detect Class 2/2.0 fax host.	<ul style="list-style-type: none"> • Advise destination that the fax host is not the required Class 2/2.0 device.
200	CALL NOT COMPLETED message appears.	Unidentifiable connection error.	<ul style="list-style-type: none"> • Check destination setup and verify device is properly connected.
201	NO DIAL TONE message appears.	Phone service not active. Cable not connected or is damaged. RJ11 telephone cord not plugged in. RJ11 telephone cord plugged into inactive or digital phone jack. Phone power off. Phone battery low. Antenna not extended or securely connected.	<ul style="list-style-type: none"> • Check connections and retry. If problem persists, replace cable. • Confirm RJ11 cord plugged into defibrillator and phone jack. • Plug RJ11 cord into different analog jack and retransmit (analog jacks are the type used for a fax host or computer modem). • Turn on phone power. • Check phone service. • Install charged phone battery. • Confirm antenna is properly connected and extended.
202	BUSY/WAITING TO REDIAL message appears.	Destination may be busy receiving report from another device.	<ul style="list-style-type: none"> • Retry transmission. • Check modem setup for both the defibrillator and host.
203	NO ANSWER message appears.	Modems failed to connect.	<ul style="list-style-type: none"> • Retry transmission. • Check modem setup for both defibrillator and host.
300	UNABLE TO CONNECT message appears.	Unidentifiable connection error.	<ul style="list-style-type: none"> • Verify destination is ready to receive transmissions. • Verify the device setup.
301	UNABLE TO CONNECT message appears.	Receiving site answered but unable to connect.	<ul style="list-style-type: none"> • Verify destination host is ready to receive transmissions.
302	UNABLE TO CONNECT message appears.	Receiving site answered but unable to connect within a timeout interval.	<ul style="list-style-type: none"> • Verify destination host is ready to receive transmissions.

Table 6-5 Troubleshooting Tips for Data Management (Continued)

ID	Observation	Possible Cause	Corrective Action
303	UNABLE TO CONNECT message appears.	Fax host error at receiving end during call establishment.	<ul style="list-style-type: none"> Verify destination fax host is operating correctly and ready to receive fax transmissions.
304	UNABLE TO CONNECT message appears.	Fax host error at receiving end during initial service negotiations.	<ul style="list-style-type: none"> Verify destination fax host is operating correctly and ready to receive fax transmissions.
401	LOST CONNECTION message appears.	Connection with destination was interrupted.	<ul style="list-style-type: none"> Verify destination host is operating correctly and ready to receive transmissions.
500	TRANSMISSION FAILED message appears.	Unidentifiable data transmission failure.	<ul style="list-style-type: none"> Verify destination host is ready to receive data and retry transmission.
501	TRANSMISSION FAILED message appears.	Computer application program is not ready or not available at this number.	<ul style="list-style-type: none"> Check destination phone number and phone number setup option. Verify that the program is ready to receive data.
502	TRANSMISSION FAILED message appears.	Fax host error during final service negotiations.	<ul style="list-style-type: none"> Verify destination fax host is operating correctly and ready to receive fax transmissions.
503	TRANSMISSION FAILED message appears.	Fax host error in failing to complete fax. File type not supported or unable to retrieve file for transmission.	<ul style="list-style-type: none"> Verify destination fax host is operating properly and ready to receive fax transmissions.
600	TRANSMISSION FAILED message appears.	Host cancelled transmission.	<ul style="list-style-type: none"> Verify destination host is operating properly and ready to receive transmissions.
601	TRANSMISSION FAILED message appears.	Host error during receive.	<ul style="list-style-type: none"> Verify destination host is operating properly and ready to receive transmissions.
*	TRANSMISSION CANCELLED message appears.	LIFEPAK 12 operator cancelled the transmission.	<ul style="list-style-type: none"> Resend transmission if cancelled in error.

* Appears as a display message only.

POWER ADAPTER

This section describes the AC Power Adapter.

Basic Orientation	page 7-2
Using the AC Power Adapter	7-5
General Maintenance	7-7

BASIC ORIENTATION

The AC Power Adapter (see Figure 7-1) is an optional accessory only for the LIFEPAK 12 defibrillator/monitor. This power adapter:

- Provides operating power to the defibrillator/monitor with or without batteries.
- Charges the batteries installed in the defibrillator/monitor.
- Indicates whether the batteries are charging, ready for service, or failed.

The AC Power Adapter operates with line power. The power adapter will not overcharge the batteries. The power adapter can be permanently attached to the defibrillator.

The power adapter charges one battery at a time; it automatically charges the battery with the greatest remaining charge first. Once fully charged, the power adapter trickle-charges the batteries to maintain the charge level.

Note: Power adapters do not maintain batteries. Battery maintenance requires using a Battery Support System. For further information regarding battery maintenance, refer to “Battery Maintenance” on page 8-8.

The following paragraphs include:

- Power Adapter Warnings
- Unpacking and Inspecting the Power Adapter
- Controls, Indicators and Connectors
- Mounting the Power Adapter to the LIFEPAK 12 defibrillator/monitor

Power Adapter Warnings

WARNINGS!

Possible device shutdown during patient care.

The AC Power Adapter charges batteries; it does not maintain batteries. Maintain batteries with the appropriate Physio-Control Battery Support System.

Possible loss of power during patient care.

Do not connect more than one DC output extension cable between the AC Power Adapter and the defibrillator. The resultant voltage drop may prevent the power adapter from charging the batteries or operating the defibrillator. Always connect the power adapter directly to the defibrillator or use only one extension cable.

Shock hazard.

Using a power line cord other than the one supplied with the AC Power Adapter could cause excess leakage currents. Use only the AC Power Adapter power cord (PN 803650).

CAUTION!

Inability to Charge Battery.

The AC Power Adapter cannot charge the LIFEPAK NiCd 2.4 amp hour battery (PN 3009376-001) unless the power adapter is labeled “LIFEPAK NiCd 2.4 AH compatible”.

CAUTION!

Potential performance degradation.

Using the AC Power Adapter with a voltage converter or inverter could degrade the performance of the power adapter. Verify that all performance parameters of the LIFEPAK 12 defibrillator/monitor meet factory specifications before using a voltage converter or inverter with the AC Power Adapter.

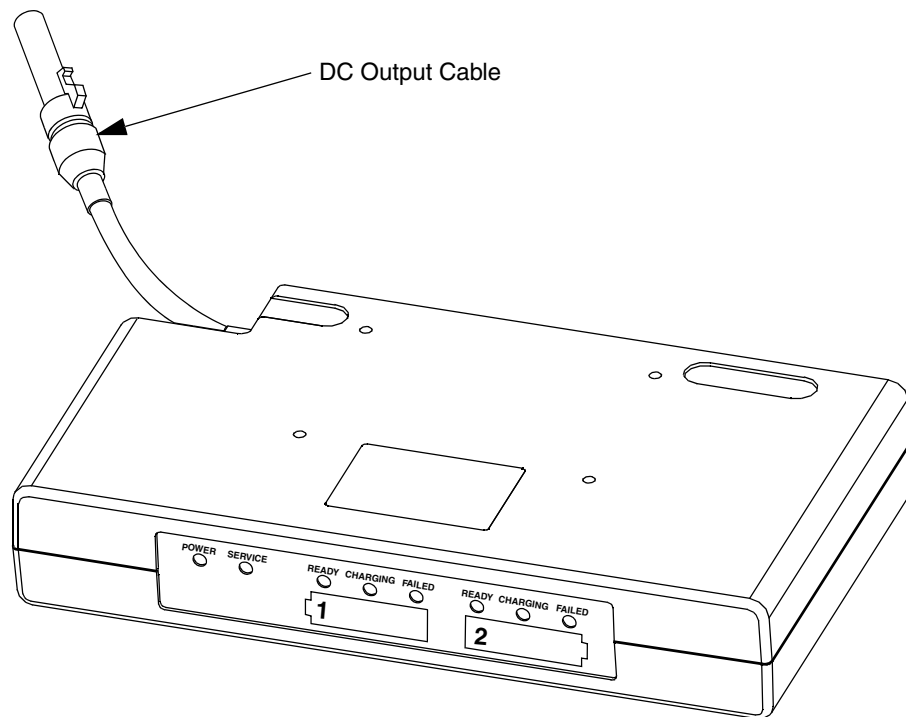

Figure 7-1 The Power Adapter

Unpacking and Inspecting

After you remove the power adapter from the shipping container, examine the power adapter and accessories for signs of damage. Make sure you have all the supplies and accessories. Save the shipping container and the foam inserts for shipping the device.

Check the voltage indicator to ensure that the correct voltage (110/230) of your power source is selected (see Figure 7-4). If the voltage displayed is incorrect, contact a qualified service technician.

CAUTION!

Power adapter damage.

If the voltage indicator is not set to the corresponding AC line voltage when the AC Power Adapter is connected to line power, the power adapter will be damaged beyond repair. Verify that the voltage indicator matches the AC voltage of your local power source.

Controls, Indicators, and Connectors

Figure 7-2 through Figure 7-4 show the controls, indicators, and connectors for the AC Power Adapter.

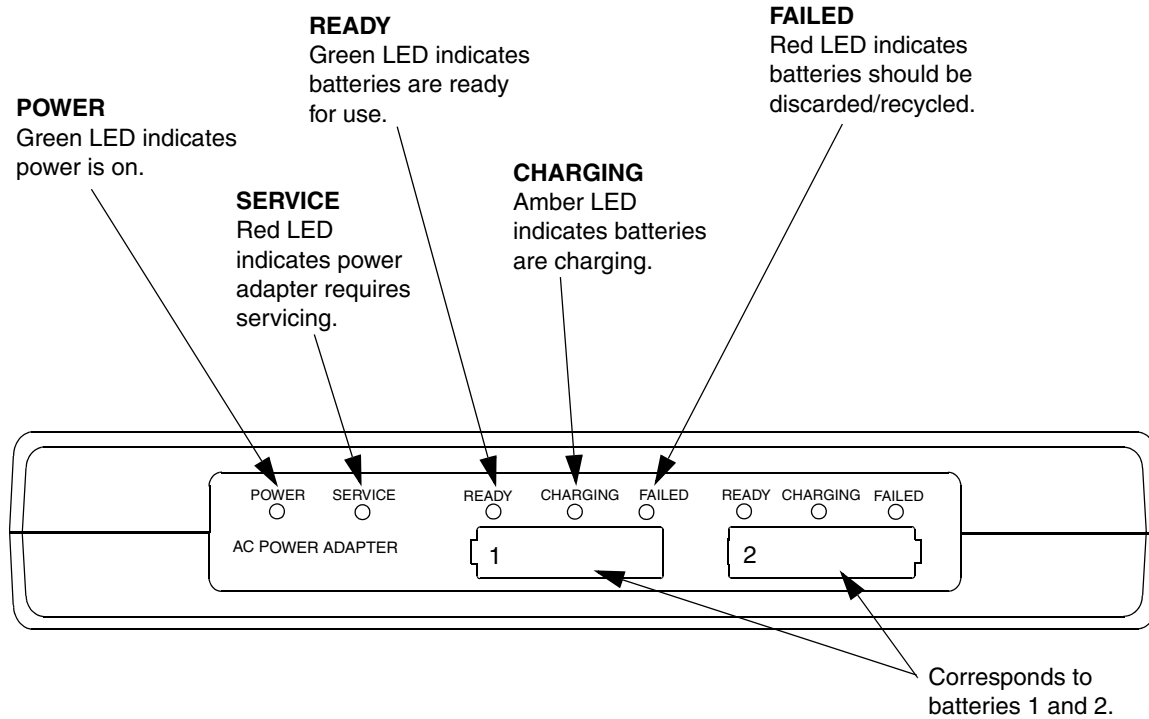

Figure 7-2 Power Adapter Front Panel

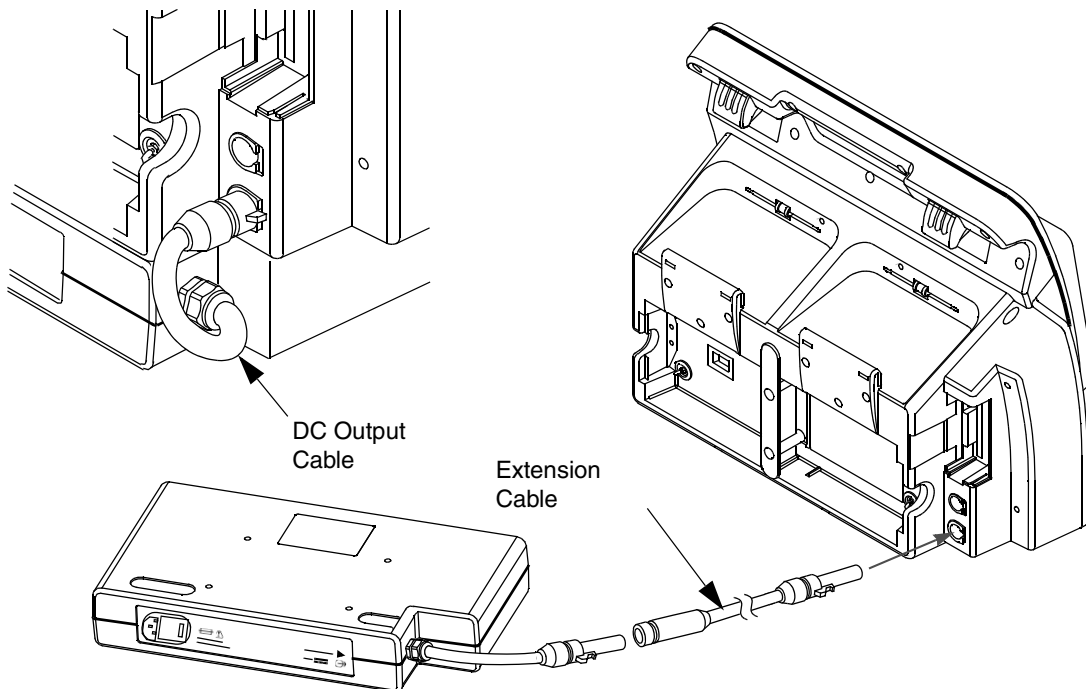

Figure 7-3 DC Output and Extension Cables

AC Power Adapter

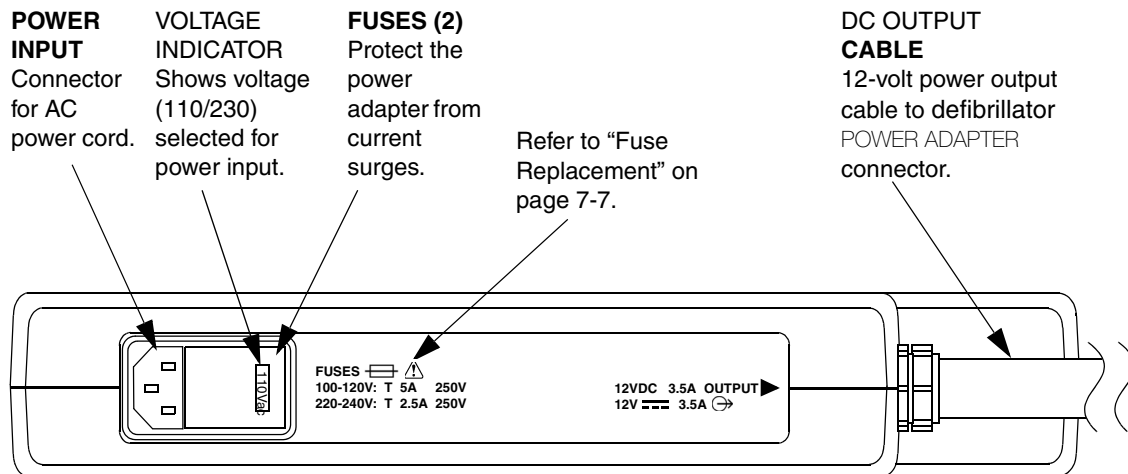

Figure 7-4 Rear View of AC Power Adapter

USING THE AC POWER ADAPTER

CAUTION!

Possible power adapter damage.

Unless permanently mounted, moving the defibrillator while connected to the power adapter may damage the power adapter and output cable. Before moving the defibrillator, disconnect the output cable.

AC Power Adapter Operation

For the AC Power Adapter:

- 1 Connect the AC power cord to the power adapter and a grounded AC outlet of the correct voltage.
- 2 Verify that the green POWER LED illuminates.
When the power adapter is first turned on, it performs a brief self-test. During this test all LEDs light for a few seconds. If the test is successful, all the LEDs extinguish with the exception of the green POWER LED.
- 3 Connect the DC output cable to the defibrillator POWER ADAPTER connector.
- 4 Press the defibrillator ON button. If at least one battery is installed in the device, verify the BATT CHG indicator is lit. If no battery is installed in the device, verify the BATT CHG indicator lights momentarily during self test.

If batteries are installed in the defibrillator, the AC Power Adapter LEDs illuminate as follows:

- READY (green): battery is fully charged.
- CHARGING (amber): battery is charging.
- FAILED (red): discard/recycle batteries.
- SERVICE (red): power adapter needs service immediately. Remove power adapter from use immediately.

Note: The SERVICE indicator on the LIFEPAK 12 defibrillator/monitor may illuminate if you turn on the defibrillator/monitor and disconnect the AC Power Adapter from the defibrillator/monitor or power source at the same time. Wait at least 2 seconds between disconnecting the power adapter and turning on the defibrillator/monitor regardless of the order of the actions. If the service

indicator comes on, continue to use the defibrillator if needed. The service condition may be cleared by turning the defibrillator off, and then back on. If the service LED remains lit, remove the defibrillator from active use and contact your service representative.

Mounting the Power Adapter to the LIFEPAK 12 Defibrillator/Monitor

The power adapter has four mounting holes to permanently mount the power adapter to the bottom of the LIFEPAK 12 defibrillator/monitor. To mount the power adapter to the defibrillator (refer to Figure 7-5):

- 1 Place the power adapter right-side-up on a stable surface.
- 2 Place the defibrillator on top of the power adapter. While holding the two devices in position, tilt them slightly to one side to expose the mounting holes on the bottom of the power adapter.
- 3 Using the 4 screws, insert the screws through the bottom of the power adapter case and into the corresponding mounting hole in the defibrillator. Hand-tighten the screws one turn after they are seated.

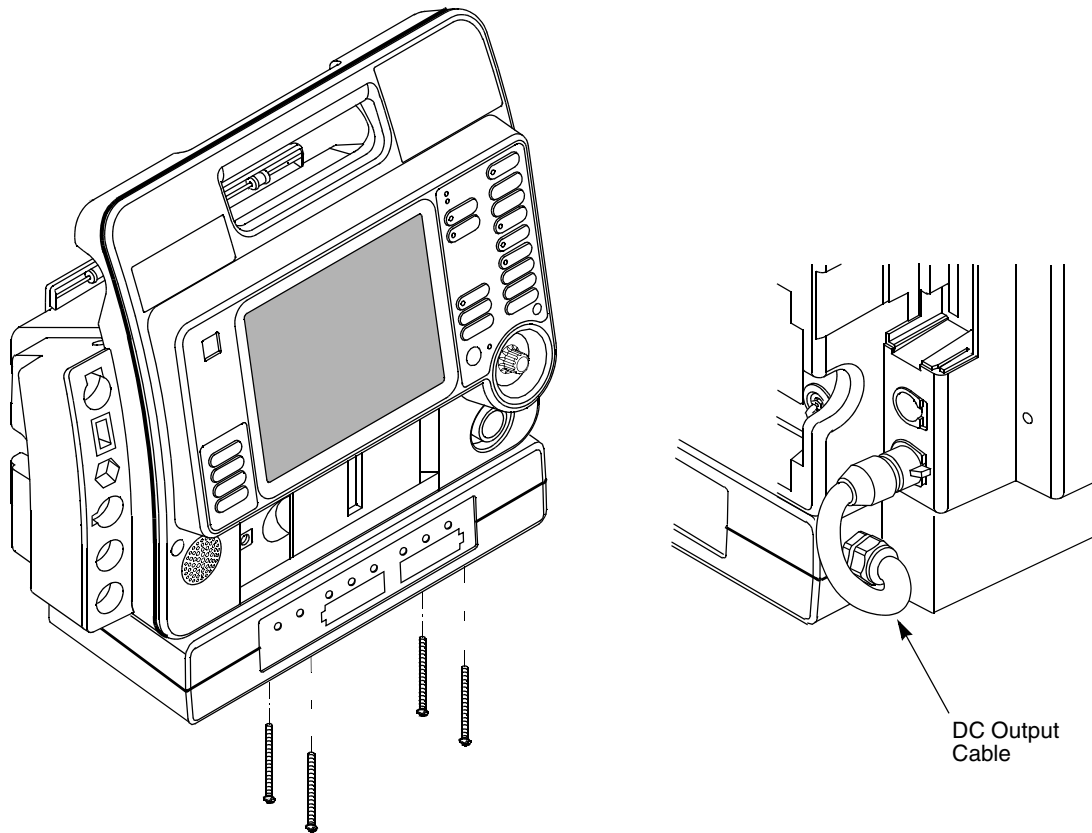

Figure 7-5 Mounting the Power Adapter to the LIFEPAK 12 defibrillator/monitor

After the power adapter is permanently mounted to the defibrillator, connect the DC output cable to the defibrillator's POWER ADAPTER connector.

GENERAL MAINTENANCE

The following paragraphs contain information about:

- Maintenance and Service
- Cleaning
- Fuse Replacement
- Troubleshooting
- Warranty
- Replacement Parts and Accessories

Maintenance and Service

Maintenance and service instructions, including periodic tests, inspections, and part replacement intervals are described in the *LIFEPAK 12 Defibrillator/Monitor Service Manual*, PN 3010013. The power adapter does not contain any operator-serviceable components. If the power adapter needs servicing, contact a Physio-Control representative. In the USA, call 1.800.442.1142. Outside the USA, contact your local Physio-Control representative.

Cleaning

WARNING!**Shock or fire hazard.**

Do not immerse any portion of this device in water or other fluids. Avoid spilling any fluids on device or accessories. Spilled liquids may cause the device and accessories to perform inaccurately or fail. Do not clean with ketones, or other flammable agents. Do not autoclave or sterilize this device or accessories unless otherwise specified.

CAUTION!**Possible equipment damage.**

Do not clean any part of this device or accessories with bleach, bleach dilution, or phenolic compounds. Do not use abrasive or flammable cleaning agents. Do not attempt to sterilize this device or any accessories unless specified in accessory Operating Instructions.

Clean the power adapter by wiping the surface with any of the following solutions:

- Soap and water
- Quaternary ammonium compounds
- Isopropyl alcohol
- Peracetic (peroxide) acid solutions

Fuse Replacement

The AC Power Adapter has two fuses. To replace the fuses, unplug the AC power cord and open the fuse carrier door located in the power input module with a flat-bladed screw driver (refer to Figure 7-4). Ensure that the replacement fuses are the same type and rating as listed in the specifications in Table A-1.

When replacing fuses on the AC Power Adapter, use only 5 x 20 mm F 250V fuses approved to IEC 127-2 sheet 1 or 2, such as:

- Schurter SP or FSF
- Bussman GDA or GDB
- Littelfuse 216

Note: Use of other fuse types may cause premature failure of the mains fuse.

Power Adapter

The back panel of the Adapter (see Figure 7-4) shows the correct fuse rating for the input voltage:

- 100-120V: T 5A
- 220-240V: T 2.5A

Troubleshooting

Table 7-1 contains corrective actions intended as an aid for non-technical personnel. If trouble persists after consulting this guide, contact a Physio-Control authorized service technician or call 1.800.442.1142 (in the USA).

Table 7-1 Troubleshooting Tips for the AC Power Adapter

Observation	Possible Cause	Corrective Action
1 POWER does not light.	AC power cord not plugged into unit or line power.	• Connect power cord.
	Blown fuse.	• Replace using the procedure described on page 7-7 with the correct fuses.
	Blown fuse or tripped circuit breaker in building.	• Contact a qualified service technician.
2 CHARGING does not light.	DC output cable not connected to defibrillator.	• Connect cable to defibrillator and power adapter.
	Power adapter malfunction.	• Contact a qualified service technician.
3 Battery power limited during use.	Battery requires conditioning.	• Condition battery with Battery Support System.
4 FAILED illuminates.	Battery voltage capacity is depleted.	• Remove battery from use and discard/recycle.
5 SERVICE illuminates.	Internal error detected.	• Power adapter requires servicing. Contact a qualified service technician.
6 Not all LEDs on the FASTPAK 2 battery illuminate when READY LED is lit.	Normal condition. Battery needs additional trickle charge time.	• Allow battery to trickle charge to full capacity. • Maintain batteries with Battery Support System 2
	Battery is at end of useful life.	• Remove battery from use and discard/recycle.

Warranty

Refer to the warranty statement shipped with the power adapter. For duplicate copies, contact your local Physio-Control representative. In the USA, call 1.800.442.1142. Outside the USA, contact your local Physio-Control sales or service office.

Replacement Parts and Accessories

In the USA, call 1.800.442.1142 to order parts and accessories. Outside the USA, contact your local Physio-Control sales or service office.

Table 7-2 Replacement Parts and Accessories

Description	Part Number
AC Power Adapter Service Manual	3010013
Extension Cable	3010910-00
AC Input Power Cord	803650

MAINTAINING THE EQUIPMENT

This section describes how to perform operator-level maintenance, testing, and troubleshooting for the LIFEPAK 12 defibrillator/monitor and selected accessories. For additional information about accessories, refer to specific accessory operating instructions.

General Maintenance and Testing	page 8-2
Battery Maintenance	8-8
General Troubleshooting Tips	8-12
Service and Repair	8-13
Product Recycling Information	8-14
Warranty	8-14
Accessories, Supplies, and Training Tools	8-15

GENERAL MAINTENANCE AND TESTING

Periodic maintenance and testing of the LIFEPAK 12 defibrillator/monitor and accessories are important to help prevent and detect possible electrical and mechanical discrepancies. If testing reveals a possible discrepancy with the defibrillator or accessories, refer to "General Troubleshooting Tips" on page 8-12. If the discrepancy cannot be corrected, immediately remove the device from service and contact a qualified service technician. For testing information regarding accessories, refer to the accessory operating instructions.

Each time you turn on the defibrillator/monitor, it performs self tests. If the defibrillator/monitor detects a failure, the Service LED will light.

A MAINTENANCE DUE message can be configured to appear on the display at selected intervals (3, 6, or 12 months) to remind you that the device is due for maintenance. The factory default is OFF, but it can be activated by service personnel.

Maintenance and Testing Schedule

Table 8-1 lists the recommended maintenance and testing schedule. This schedule may be used in conjunction with the internal quality assurance program of the hospital, clinic, or emergency medical service where the defibrillator is used.

Cables and paddles are a critical part of therapy delivery and suffer wear and tear. Therapy cable testing as described in the Operator's Checklist included in these instructions is recommended on a daily basis (refer to Appendix C, "Operator's Checklist"). Physio-Control recommends replacement of these accessories every three years to reduce the possibility of failure during patient use.

Additional periodic preventive maintenance and testing—such as electrical safety tests, performance inspection, and required calibration—should be performed regularly by qualified service technicians.

Table 8-1 Recommended Maintenance Schedule for Clinical Personnel

Operation	Daily	After Use	As Required	Monthly	3 Months	6 Months	12 Months
Complete Operator's Checklist (Appendix C). Includes QUIK-COMBO therapy cable check and Standard Paddles Monitoring and User Test.	X						
Inspect defibrillator.	X	X					
Clean defibrillator.		X	X				
Check that all necessary supplies and accessories are present (for example, fully charged batteries, gel, electrodes, ECG paper, etc.).	X	X	X				
Function Checks:							
Patient ECG cable check						X	
Standard Paddles defibrillation and synchronized cardioversion check				X			
Therapy Cable monitoring and synchronized cardioversion check						X	
Therapy Cable pacing check						X	
Power Adapter check							X
NiCd batteries: Reconditioning (alternate with Shelf Life Test). (SLA optional.)					X		
NiCd batteries: Shelf Life Test. (SLA optional.)						X	

Table 8-1 Recommended Maintenance Schedule for Clinical Personnel

Operation	Daily	After Use	As Required	Monthly	3 Months	6 Months	12 Months
Preventive Maintenance and Testing.							X

WARNING!

Possible loss of power during patient care.

Battery pins in the defibrillator may be damaged if batteries are dropped or forced into battery wells. Inspect pins routinely for signs of damage.

User Test

The User Test is a functional test of the LIFEPAK 12 defibrillator/monitor and should be performed only as a test and not while using the defibrillator during patient care.

Perform the User Test as a part of completing the daily Operator’s Checklist (refer to Appendix C, "Operator’s Checklist").

If performing a User Test separate from completing the Operator’s Checklist:

- 1 Press ON to turn on the defibrillator/monitor. If disconnecting the defibrillator/monitor from AC or DC line power, **wait at least 2 seconds** between disconnecting and powering on regardless of the order of these actions. This allows the defibrillator/monitor time to switch to battery power.
- 2 Press OPTIONS to access User Test. When selected, the User Test automatically performs the following tasks:
 - Performs self-tests
 - Charges to 10J and discharges internally (this energy is not accessible at the therapy connector)
 - Prints a Pass/Fail report

If the LIFEPAK 12 defibrillator/monitor detects a failure during the User Test, the Service LED lights and the printed report indicates that the test failed. Turn off the defibrillator and perform the therapy cable or the standard paddles defibrillation check. If the Service LED remains lit or reappears, contact a qualified service technician.

If it is necessary to interrupt the User Test, turn the power off and then on again. The test will stop and the defibrillator will operate normally. A Pass/Fail report will not print.

Note: During the User Test, all front panel controls (except ON) and Standard Paddle controls are disabled. Routinely testing the defibrillator consumes battery power; maintain all batteries as described on page 8-8.

Note: The last 40 User Test results are transmitted with all reports to the CODE-STAT Suite data management system.

Note: It is important to understand defibrillator operation. Refer to page 8-2 through page 8-7 for suggested procedures to help keep personnel acquainted with normal defibrillator operation and to troubleshoot device performance. The procedures used may vary according to your local protocols. To test the defibrillator by performing the function checks requires the use of an optional Test Load or simulator.

Standard Paddles User Test

Perform the Standard Paddles User Test as a part of completing the daily Operator’s Checklist (See “Appendix C”).

Cleaning

CAUTION!

Possible equipment damage.

Do not clean any part of this device or accessories with bleach, bleach dilution, or phenolic compounds. Do not use abrasive or flammable cleaning agents. Do not attempt to sterilize this device or any accessories unless otherwise specified in the accessory operating instructions.

Clean the LIFEPAK 12 defibrillator/monitor, cables, and accessories with a damp sponge or cloth. Use only the cleaning agents listed below:

- Quaternary ammonium compounds
- Isopropyl alcohol
- Peracetic (peroxide) acid solutions

Function Checks

CAUTION!

Possible simulator damage.

Do not discharge more than 30 shocks within an hour or 10 shocks within a five-minute period, or pace continually into Physio-Control patient simulators. Simulators may overheat.

The following function checks are provided to help personnel keep acquainted with normal operating procedures and to troubleshoot device performance. The defibrillator checker and Test Load referred to in these function checks are accessories available from Physio-Control. One Test Load is provided with each LIFEPAK 12 defibrillator/monitor.

Note: Older Physio-Control simulators and testers respond differently to defibrillators configured with a biphasic defibrillation waveform. Older QUIK-COMBO simulators require a 275 joule biphasic shock to change simulated VF rhythm to NSR. Sometimes no amount of energy can change the simulated VF rhythm. The PACE LED flashes when the shock does not change the simulated rhythm.

Newer QUIK-COMBO simulators, described in the Physio-Control accessories catalog and on the Web site, respond appropriately to defibrillators with a biphasic defibrillation waveform. For further information, in the USA, call 1.800.442.1142. Outside the USA, contact your local Physio-Control representative.

Patient ECG Cable Check

Equipment Needed:

- LIFEPAK 12 defibrillator/monitor
- Fully charged batteries
- Patient ECG cable (3-lead or 12-lead)
- 3-lead or 12-lead simulator

Procedure:

- 1 Press ON.
- 2 Connect the ECG cable to the defibrillator.
- 3 Connect all cable leads to the simulator.
- 4 Turn on the simulator and select a rhythm.
- 5 After a few seconds confirm that the screen displays a rhythm and no LEADS OFF or SERVICE message appears.
- 6 For 12-lead cable, press 12-LEAD and wait for printout. Confirm a rhythm prints for each lead.

Standard Paddles Defibrillation and Synchronized Cardioversion Check

WARNING!

Shock hazard.

When discharged as described in this test, the defibrillator delivers up to 360 joules of electrical energy. Unless discharged properly as described in this test, this electrical energy may cause serious personal injury or death. Do not attempt to perform this test unless you are qualified by training and experience and thoroughly familiar with these Operating Instructions.

Equipment Needed:

- LIFEPAK 12 defibrillator/monitor
- Standard paddles
- Defibrillator checker
- Patient ECG cable
- 3-lead or 12-lead patient simulator
- Fully charged batteries

Procedure

- 1 Press ON.
- 2 Connect the ECG cable to the monitor and the patient simulator.
- 3 Turn on the simulator and select any rhythm except asystole or ventricular fibrillation.
- 4 Select Lead II.
- 5 Press SYNC. Confirm the SYNC LED lights. Adjust ECG size until the sense markers appear on the QRS complexes. Confirm that the SYNC LED blinks off with each detected QRS complex and the heart rate is displayed.
- 6 Select 200 joules.
- 7 Press CHARGE and confirm that the tone indicating full charge sounds within 10 seconds or less.
- 8 Place the standard paddles on the defibrillator checker paddle plates.
- 9 Press the APEX discharge button, confirm that the defibrillator does not discharge, and then release the button.
- 10 Press the STERNUM discharge button, confirm that the defibrillator does not discharge, and then release the button.
- 11 Press PRINT.

WARNING!

Possible paddle damage and patient burns.

Press paddles firmly onto the defibrillator checker plates when discharging to prevent arcing and formation of pits on paddle surfaces. Pitted or damaged paddles may cause patient skin burns during defibrillation.

- 12 Apply firm pressure with both paddles on the defibrillator checker paddle plates, and simultaneously press and **hold** both discharge buttons while observing the screen.
- 13 Confirm the defibrillator discharges on the next sensed QRS complex.
- 14 Confirm the defibrillator returns to asynchronous mode (sense markers are no longer displayed and SYNC LED is off).

Note: Defibrillator may be configured to remain in sync mode after discharge.
- 15 Confirm that the printer annotates the time, date, Sync On, sense markers prior to energy delivered, energy selected, no sense markers after Shock 1, and Sync Off on the ECG strip.
- 16 Turn off the defibrillator.

Note: If a CONNECT CABLE, PADDLES LEADS OFF, or any other warning message appears, replace the paddle assembly and repeat the test. If the problem cannot be corrected, remove the device

Maintaining the Equipment

from active use and contact a qualified service representative.

Therapy Cable Monitoring and Synchronized Cardioversion Check

Equipment Needed:

- LIFEPAK 12 defibrillator/monitor
- QUIK-COMBO (or FAST-PATCH) therapy cable
- Patient ECG cable
- QUIK-COMBO 3-lead or 12-lead patient simulator, or posted patient simulator
- Fully charged batteries

Procedure:

- 1 Press **ON**.
- 2 Connect the ECG cable to the defibrillator and the simulator.
- 3 Connect the therapy cable to the simulator.
- 4 Turn on the simulator and select any rhythm except asystole or ventricular fibrillation.
- 5 Select **PADDLES** lead.
- 6 Confirm that the screen displays a normal sinus rhythm and that the **PADDLES LEADS OFF** message does not appear.
Note: If the screen displays dashed lines, artifact (irregular noise signals), or any warning message, replace the therapy cable and repeat the test. If the problem cannot be corrected, remove the defibrillator from active use and contact a qualified service representative.
- 7 Select **Lead II**.
- 8 Press **SYNC**. Confirm that the **SYNC LED** lights. Adjust the ECG size until sense markers appear on the QRS complexes. Confirm that the **SYNC LED** blinks off with each detected QRS complex and that the heart rate is displayed.
- 9 Select **50 joules**.
- 10 Press **CHARGE**.
- 11 Press **PRINT**.

WARNING!

Shock hazard.

During defibrillation checks, the discharged energy passes through the cable connectors. Securely attach cable connectors to the simulator.

- 12 After the tone sounds indicating full charge, press and hold **SHOCK** while observing the monitor screen.
- 13 Confirm that the defibrillator discharges on the next sensed QRS complex.
- 14 Confirm that the defibrillator returns to asynchronous mode (sense markers are no longer displayed and the **SYNC LED** is off).
- 15 Disconnect the therapy cable from the simulator. Confirm the **PADDLES LEADS OFF** message appears and an audible alarm sounds.
Note: Defibrillator may be configured to remain in sync mode after discharge.
- 16 Confirm that the printer annotates the time, date, Sync On, sense markers prior to energy delivered, energy selected, no sense markers after Shock 1, and Sync Off on the ECG strip.
- 17 Turn off the defibrillator.

Therapy Cable Pacing Check

Equipment Needed:

- LIFEPAK 12 defibrillator/monitor
- QUIK-COMBO therapy cable
- Patient ECG cable

- QUIK-COMBO 3- or 12-lead patient simulator
- Fully charged batteries

Procedure:

- 1 Press **ON**.
- 2 Connect the QUIK-COMBO therapy cable to the QUIK-COMBO simulator.
- 3 Turn on the simulator and select **BRADY**.
- 4 Connect the ECG cable to the defibrillator and the simulator.
- 5 Select **Lead II**.
- 6 Press **PACER**.
- 7 Confirm that sense markers appear on each QRS complex. If sense markers do not appear, or appear elsewhere on the ECG, press the **SELECTOR** on waveform Channel 1 and adjust ECG size from the overlay.
- 8 Confirm that the **RATE** overlay appears.
- 9 Press **CURRENT** and increase the current to 80 mA.
- 10 Observe the screen for captured complexes. Confirm the **PACER LED** flashes with each delivered pacing pulse.
- 11 Disconnect the QUIK-COMBO therapy cable from the simulator. Confirm the pacemaker stops pacing, the **CONNECT ELECTRODES** message appears, and an audible alarm sounds.
- 12 Reconnect the QUIK-COMBO therapy cable to the simulator. Confirm audible alarm stops and **PACING STOPPED** message is displayed and current is 0 mA.
- 13 Increase current to 80 mA.
- 14 Press **CHARGE**. Confirm the **PACER LED** goes off and heart rate and available energy are displayed.

AC Power Adapter Check

The AC Power Adapter may not be available for use in all countries. Contact your local Physio-Control representative.

Equipment Needed:

- LIFEPAK 12 defibrillator/monitor
- AC Power Adapter with access to power source
- Fully charged batteries

Procedure:

- 1 Connect the AC Power Adapter to AC power.
- 2 Confirm the AC Power Adapter front panel **POWER** light is illuminated.
- 3 Remove the batteries from the defibrillator.
- 4 Confirm the defibrillator powers on without the **SERVICE LED** illuminated.
- 5 Install fully charged batteries in the defibrillator and confirm the battery charging light illuminates on the defibrillator.

BATTERY MAINTENANCE

The following paragraphs describe:

- Battery Maintenance Warnings
- Battery Description
- NiCd Battery Performance Factors
- SLA Battery Performance Factors
- Receiving New Batteries
- Storing Batteries
- Recycling Batteries at the End of Useful Life

Battery Maintenance Warnings

WARNINGS!

Possible loss of power and delay of therapy during patient care.

Using an improperly maintained battery to power the defibrillator may cause power failure without warning. Use the appropriate Physio-Control Battery Support System to charge and condition batteries.

Possible loss of power during patient care.

Physio-Control has no information regarding the performance or effectiveness of its LIFEPAK defibrillator/monitors if they are used with other manufacturers' batteries or battery chargers. Using other manufacturers' batteries or battery chargers may result in device failure and may void the warranty. Use only Physio-Control batteries and the appropriate Physio-Control Battery Support System for the battery used.

CAUTIONS!

Possible battery damage.

Overdischarging may shorten battery life. When the low or replace battery indicator appears, replace the battery or connect the power adapter. Do not continue using the battery.

Possible inaccurate battery charge indicator.

Using the Physio-Control Battery Support System (PN 801807) or the two-well Battery Charger (PNs 9-00284, 9-00288, and 801530) to charge and maintain a FASTPAK 2 battery will eventually result in an inaccurate battery charge level indicator. Use only the Battery Support System 2 (PN 3010035) to charge and maintain FASTPAK 2 batteries.

The following paragraphs contain general information concerning Physio-Control batteries. Using batteries from sources other than Physio-Control is not recommended. Physio-Control has no information regarding the performance or effectiveness of its LIFEPAK defibrillators if they are used in conjunction with batteries from other sources.

Batteries require maintenance to help maximize battery life and performance. For more information, refer to the Battery Support System 2 Operating Instructions and the *LIFEPAK 12 Defibrillator/Monitor Service Manual*.

Battery Description

The LIFEPAK 12 defibrillator/monitor is powered by Physio-Control FASTPAK, FASTPAK 2, LIFEPAK NiCd, or LIFEPAK SLA batteries. FASTPAK, FASTPAK 2, and LIFEPAK NiCd batteries have a nickel cadmium (NiCd) chemistry and LIFEPAK SLA batteries have a sealed lead acid (SLA) chemistry.

Battery Charging, Conditioning, and Shelf Life Testing

To maximize battery life in the LIFEPAK 12 defibrillator/monitor:

- After use, replace both batteries with fully charged batteries; or, if the device was only used briefly, remove the battery in well 1 for recharging, move the battery in well 2 to the well 1 position, and install a fresh, fully charged battery in well 2.
- You may wish to charge batteries every week, even when device usage is light, and rotate all batteries in active use so that they are used with equal frequency.

Charge FASTPAK batteries in either the Battery Support System (PN 801807), the Battery Support System 2 (PN 3010035), or the LIFEPAK 12 defibrillator/monitor when it is powered by the AC Power Adapter. FASTPAK batteries **require** periodic conditioning and shelf life testing to optimize performance. Condition and shelf life test FASTPAK batteries in the Battery Support System or Battery Support System 2.

Charge the FASTPAK 2 and LIFEPAK NiCd batteries in the Battery Support System 2 or in the LIFEPAK 12 defibrillator/monitor when it is powered by the AC Power Adapter. Using the Battery Support System (PN 801807) or the two-well Battery Charger (PNs 9-00284, 9-00288, and 801530) to charge and maintain a FASTPAK 2 battery will eventually result in an inaccurate battery charge level indicator. FASTPAK 2 and LIFEPAK NiCd batteries **require** periodic conditioning and shelf life testing to optimize performance. Condition and shelf life test FASTPAK 2 and LIFEPAK NiCd batteries only in the Battery Support System 2. Refer to the Battery Support System or Battery Support System 2 Operating Instructions for more information about NiCd battery maintenance.

Charge SLA batteries either in the Battery Support System 2 or in the LIFEPAK 12 defibrillator/monitor when it is powered by the AC Power Adapter. Periodic conditioning and shelf life testing may optimize SLA battery performance, but are not required. Use the Battery Support System 2 to condition and shelf life test LIFEPAK SLA batteries. Refer to the Battery Support System 2 Operating Instructions for more information about SLA battery maintenance.

NiCd Battery Performance Factors

Three major factors affect the performance of NiCd batteries: temperature, voltage depression, and the self-discharge rate.

Temperature

Charging batteries at room temperature 20° to 25°C (68° to 78°F) is preferred to maximize battery performance and life. The extreme temperature range for charging batteries is 5° to 35°C (41° to 95°F).

CAUTION!

Possible battery damage.

Charging a battery at temperatures below 5°C (41°F) or above 35°C (95°F) prevents the battery from reaching its full capacity and may lead to irreversible cell damage.

Voltage Depression

Voltage depression is a condition that reduces battery performance. When NiCd batteries repeatedly receive a shallow discharge (that is, not allowed to drain completely between charging cycles) voltage depression occurs. This condition is often mistakenly called “memory.”

Voltage depression can usually be reversed by conditioning the battery every three months.

Self-Discharge Rate

Batteries self-discharge when not used. A new NiCd battery self-discharges approximately 1% of its capacity each day when stored at room temperature. In 10 days a new NiCd battery not installed in the defibrillator loses approximately 10% of its capacity.

Maintaining the Equipment

Use the Battery Support System 2 to evaluate the self-discharge rate of a FASTPAK or LIFEPAK NiCd battery by performing a shelf life test.

The actual battery self-discharge rate depends on:

- Battery age
- Temperature
- Frequency of use
- Length of time in storage
- Physical battery condition



These factors can combine to significantly increase the battery discharge rate. For example, an older battery stored in higher temperatures may have an accelerated self-discharge rate much greater than 1% a day.

The self-discharge rate increases as the battery ages.

Battery Fuel Gauge

Capacity and charge are the two factors that determine how long a battery will provide power for the LIFEPAK 12 defibrillator/monitor. The NiCd 2.4 Ah battery fuel gauge is designed to show both the remaining capacity and how much charge is left in the battery.

Table 8-2 NiCd Battery Fuel Gauge

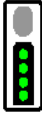
Battery Fuel Gauge	Description
	<ul style="list-style-type: none">• If just removed from the battery charger, the battery has approximately 50% remaining capacity.• If observed after use, the battery may have reduced capacity, reduced remaining charge, or a combination of both.
	<ul style="list-style-type: none">• If just removed from the battery charger, the battery has approximately 75% remaining capacity.• If observed after use, the battery may have reduced capacity, reduced remaining charge, or a combination of both.
	<ul style="list-style-type: none">• This battery is fully charged and has full capacity.

Note:

- Older batteries will eventually display less than four bars when charged.
- Batteries that display only one or two bars after being fully charged will have shorter use times in the LIFEPAK 12 defibrillator/monitor (approximately 20 to 60 minutes, depending on features in use).

SLA Battery Performance Factors

Three major factors affect the performance of SLA batteries: storage, undercharging, and self-discharge rate.

Storage

Storing a battery that is less than 100% charged can result in permanent damage.

Undercharging

Fully charge SLA batteries between uses. If SLA batteries are not 100% recharged between uses, sulfation (lead sulfate buildup on electrode surfaces inside the battery) can occur. Sulfation reduces battery capacity and may result in premature battery failure.

Self-Discharge Rate

SLA batteries have a low self-discharge rate. A new SLA battery self-discharges approximately 0.1% of its capacity each day when stored at room temperature. In 10 days a new SLA battery loses approximately 1.0% of its capacity.

The self-discharge rate increases as the battery ages.

Receiving New Batteries

When newly-purchased batteries are received, charge each new battery. Because batteries self-discharge during storage, a new battery may not be fully charged when it is received.

Storing Batteries

WARNING!

Possible loss of power during patient care.

Stored batteries lose charge. Failure to charge a stored battery before use may cause device power failure without warning. Always charge a stored battery before placing it in active use.

Store batteries in or out of the Battery Support System 2 except when performing a shelf life test. Batteries still require routine maintenance, even while in storage.

When storing batteries:

- Store batteries between 4.4° and 26.7°C (40° and 80°F). Lower temperatures reduce the battery self-discharge rate. Higher temperatures increase the self-discharge rate.
- Fully charge SLA batteries before storing.
- Do not freeze batteries. Damage to the battery may result.
- Charge stored batteries before placing in use.

Recycling Batteries at the End of Useful Life

Physio-Control recommends that batteries be replaced every two years. Properly maintained batteries may last longer, but have shorter use times due to reduced storage capacity. A FASTPAK, FASTPAK 2, LIFEPAK NiCd, or LIFEPAK SLA battery has reached the end of useful life if *one or more* of the following circumstances occur:

- Battery fails conditioning or shelf-life test.
- There is physical damage to the battery case.
- The battery is leaking.
- The Battery Support System 2 indicates DISCARD during any battery maintenance procedure.

Note: The LIFEPAK SLA battery has internal parameters that establish limits for useful life. If these parameters are exceeded, the Battery Support System 2 will indicate DISCARD when the battery is inserted into the battery well.

CAUTION!

Inability to charge battery.

When the Use By date on the LIFEPAK SLA battery is reached, the battery (a) can no longer be charged, (b) will activate DISCARD on the Battery Support System 2, and (c) must be discarded.

To promote awareness of battery recycling, Physio-Control batteries are marked with one of these symbols:



When a Physio-Control battery has reached the end of its useful life, recycle the battery as follows:

Battery Recycling in the USA

Recycle batteries by participating with Physio-Control in a national recycling program. Contact your Physio-Control representative to obtain shipping instructions and shipping containers. Do not return your batteries to the Physio-Control offices in Redmond, Washington, unless instructed to do so by your Physio-Control representative.

Battery Recycling Outside the USA

Recycle batteries according to national and local regulations. Contact your local Physio-Control representative for assistance.

GENERAL TROUBLESHOOTING TIPS

If a problem is detected with the defibrillator/monitor during operation or testing, refer to the troubleshooting tips in Table 8-3. If the problem cannot be corrected, remove the defibrillator/monitor from active use and contact a qualified service technician for service and repair.

Table 8-3 General Troubleshooting Tips

Observation	Possible Cause	Corrective Action
1 No power when defibrillator/monitor is turned ON.	Low battery voltage.	<ul style="list-style-type: none"> Replace with fully charged, properly maintained battery.
	Battery connector pin loose, covered with foreign substance, or damaged.	<ul style="list-style-type: none"> Remove battery and inspect pins. Clean if foreign substance present. Contact a qualified service technician to replace if bent, cracked, or loose.
2 Defibrillator/monitor operates, but display is blank.	Operating temperature is too low or too high.	<ul style="list-style-type: none"> Replace the battery immediately.
	Display not operating properly.	<ul style="list-style-type: none"> Contact qualified service technician.
3 CHECK PRINTER message displays.	Printer paper jams, slips, or misfeeds.	<ul style="list-style-type: none"> Reinstall paper.
	Printer is out of paper.	<ul style="list-style-type: none"> Add new paper. If problem persists, contact qualified service technician.
4 No power when power adapter connected.	Improper connection between power adapter and defibrillator or power source.	<ul style="list-style-type: none"> Check power adapter connections and cables. Check AC Power Adapter is connected to AC line power.
5 Service LED illuminates.	Device self-test circuitry detects service condition.	<ul style="list-style-type: none"> Continue to use defibrillator or pacemaker if needed. Turn device off then on again. Note that this creates a new "patient." If service LED does not clear, remove device from active use. Report occurrence of service LED to qualified service personnel.
6 State of charge not displayed when LIFEPAK NiCd battery is in battery well.	Battery needs conditioning.	<ul style="list-style-type: none"> Condition the battery. Refer to page 8-10.
7 ECG monitoring problems.		<ul style="list-style-type: none"> Refer to Section 3, page 3-8.

Table 8-3 General Troubleshooting Tips (Continued)

Observation	Possible Cause	Corrective Action
8 Problems with AED operation.		<ul style="list-style-type: none"> • Refer to Section 4, page 4-4.
9 Problems with defibrillation/synchronized cardioversion.		<ul style="list-style-type: none"> • Refer to Section 4, page 4-17.
10 Problems with pacing.		<ul style="list-style-type: none"> • Refer to Section 4, page 4-18.
11 Displayed time is incorrect.	Time is incorrectly set.	<ul style="list-style-type: none"> • Change the time setting. Refer to Section 2, page 2-9.
12 Date printed on report is incorrect.	Date is incorrectly set.	<ul style="list-style-type: none"> • Change the date setting. Refer to Section 2, page 2-9.
13 Displayed messages are faint or flicker.	Low battery power. Out of temperature range.	<ul style="list-style-type: none"> • Replace the battery immediately.
14 Low speaker volume.	Moisture in speaker grill holes.	<ul style="list-style-type: none"> • Wipe moisture from speaker grill and allow device to dry.
15 MAINTENANCE DUE message appears	Maintenance prompt is set to display at a selected interval in Service mode.	<ul style="list-style-type: none"> • Continue to use device if needed. • Contact service personnel to reset or turn off the maintenance prompt. • Contact Physio-Control Technical Support for instructions on how to reset or turn off this prompt.

SERVICE AND REPAIR

WARNINGS!

Shock hazard.

Do not disassemble the defibrillator. It contains no operator serviceable components and dangerous high voltages may be present. Contact a qualified service technician for repair.

Possible ineffective energy delivery.

Service mode is for authorized personnel only. Improper use of service mode may inappropriately alter the device's configuration and may change energy output levels. Contact qualified service technician for assistance or information about device configuration.

If the LIFEPAK 12 defibrillator/monitor requires service as indicated by testing, troubleshooting, or a service message, contact a qualified service technician, or in the USA, call Physio-Control Technical Support at 1.800.442.1142. Outside the USA, contact your local Physio-Control representative.

When calling Physio-Control to request service, identify the model and serial number and describe the observation. If the device must be shipped to a service center or the factory, pack the device in the original shipping container, if possible, or in protective packing to prevent shipping damage.

The *LIFEPAK 12 Defibrillator/Monitor Service Manual* provides detailed technical information to support service and repair by a qualified service technician.

PRODUCT RECYCLING INFORMATION

All materials should be recycled according to national and local regulations. Contact your local Physio-Control representative for assistance or refer to www.physio-control.com/recycling for instructions on disposing of this product.

Recycling Assistance

The device should be recycled according to national and local regulations. Contact your local Physio-Control representative for assistance.

Preparation

The device should be clean and contaminant-free prior to being recycled.

Recycling of Disposable Electrodes

After using disposable electrodes, follow your local clinical procedures for recycling.

Packaging

Packaging should be recycled according to national and local regulations.

WARRANTY

Refer to the warranty statement included in the accessory kit shipped with the product. For duplicate copies, contact the local Physio-Control representative. In the US, call 1.800.442.1142. Outside the USA, contact your local Physio-Control sales or service office.

Using defibrillation electrodes, adapter devices or other parts and supplies from sources other than Physio-Control is not recommended. Physio-Control has no information regarding the performance or effectiveness of its LIFEPAK defibrillators if they are used in conjunction with defibrillation electrodes or other parts and supplies from other sources. If device failure is attributable to defibrillation electrodes or other parts or supplies not manufactured by Physio-Control, this may void the warranty.

ACCESSORIES, SUPPLIES, AND TRAINING TOOLS

Accessories, supplies, and training tools for the LIFEPAK 12 defibrillator/monitor are listed in Table 8-4. For information about ordering, contact your local Physio-Control representative. In the USA, call 1.800.442.1142.

Table 8-4 Accessories, Supplies, and Training Tools

Description
Maintenance and Power Accessories
REDI-CHARGE battery charger
Battery Support System 2
Battery Support System 2 wall mount bracket
Lithium-ion battery
FASTPAK battery
FASTPAK 2 battery
LIFEPAK SLA battery
LIFEPAK NiCd battery
AC Power Adapter (includes AC Input Power Cord)
Power Adapter Extension cable
Defibrillator Checker (not available in the European Union)
Therapy Accessories
QUIK-COMBO pacing/defibrillation/ECG electrodes
QUIK-COMBO pacing/defibrillation/ECG electrodes, RTS (radiotransparent system)
Pediatric QUIK-COMBO pacing/defibrillation/ECG electrodes, RTS (radiotransparent system)
QUIK-COMBO pacing/defibrillation/ECG electrodes with REDI-PAK preconnect system
QUIK-COMBO therapy cable
FAST-PATCH adapter cable
FAST-PATCH pacing/defibrillation/ECG electrodes
Standard hard paddles
Pediatric paddle adapter (two required)
Internal paddles
QUIK-COMBO Test Load (for use with QUIK-COMBO therapy cable only)
SpO2 Accessories (Masimo)
Disposable LNOP and LNCS Adhesive sensors
Disposable sensor sample kit
Reusable LNOP and LNCS sensors
Ambient light shields
Patient extension cables, LNOP and LNCS
SpO2 Accessories (Nellcor)
Disposable Nellcor sensors
Reusable Nellcor sensors
Adhesive wraps

Description

ECG Accessories

3-lead ECG cable

5-wire ECG cable

12-lead ECG cable (includes main 4-wire cable and precordial lead attachment)

ECG electrodes (not approved in the European Union)

NIBP Accessories

NIBP Hoses

Reusable blood pressure cuffs

Disposable blood pressure cuffs

EtCO₂ Accessories

FilterLine Set Adult/Pediatric (includes filter line and airway adapter)

FilterLine H Set Adult/Pediatric (includes filter line and airway adapter)

FilterLine

FilterLine H

Smart Capnoline Plus Adult

Smart Capnoline Pediatric

Data Management Software and Accessories

Modem Door Assembly (replaces PC Card cover when a PC Card is installed)

Wireless Modem/Gateway

Direct Connect LIFEPAK Monitor-to-PC Cable (serial communication cable)

Carrying Case, Accessories, and Replacement Parts

Basic Carrying Case (includes shoulder strap, right pouch, left pouch, and front cover)

Carrying Case for use with AC Power Adapter (includes shoulder strap, right pouch, left pouch, and front cover)

Shoulder strap (replacement)

Right pouch (replacement)

Left pouch (replacement)

Front cover (replacement)

Carrying Case Base and Side Supports (replacement)

Top pouch

Back pouch

Removeable Acrylic Screen Shield

Therapy Connector Guards

Supplies

Recorder paper

Training Tools

QUIK-COMBO 3-lead simulator

QUIK-COMBO 12-lead simulator

Reusable training electrodes

DEFINING SETUP OPTIONS

This section describes how to define setup options for the LIFEPAK 12 defibrillator/monitor.

Setup Options	page 9-2
Entering Setup Options	9-3
General Setup Menu	9-3
Manual Mode Setup Menu	9-4
AED Mode Setup Menu	9-5
Pacing Setup Menu	9-7
Monitoring Menu	9-7
12-Lead Setup Menu	9-9
Events Setup Menu	9-9
Alarms Setup Menu	9-10
Printer Setup Menu	9-10
Transmission Setup Menu	9-11
Clock Setup Menu	9-17
Reset Defaults Setup Menu	9-17
Print Defaults	9-18
Send Configuration Setup Menu	9-18
Set Passcode Setup Menu	9-18
Service Mode	9-18
Entering Telephone Number and Prefix Characters	9-19
Setting Up Transmit Sites	9-19

SETUP OPTIONS

The setup options allow you to define operating features for the LIFEPAK 12 defibrillator/monitor such as device identification numbers, power-on default settings, and 12-lead ECG operating functions.

Table 9-1 through Table 9-33 list all setup options along with the factory settings.

WARNING!

Possible improper device performance.

Changing factory default settings will change the behavior of the device. Changes to the default settings must only be made by authorized personnel.

Print Configurations Before Service or Repair

If the defibrillator receives service or repair that affects the internal memory components, such as replacement of the main printed circuit board, any changes previously made to the option definitions may be lost from memory. Before allowing service or repair, be sure to print the current user setup defaults so the customized definitions may be reentered after service or repair. (See "Print Defaults" on page 9-18.)

Passcode Security

To prevent unauthorized access, a security passcode is required for access to the setup menu and service mode (see page 9-18). The LIFEPAK 12 defibrillator/monitor allows you to change both of these passcodes. The passcode definition is part of the device identification option and may be changed.

Note: To use the defibrillator with any new settings, you must turn it off and then on again.

WARNING!

Possible ineffective energy delivery.

Service mode is for authorized personnel only. Improper use of service mode may inappropriately alter the device's configuration and may change energy output levels. Contact service personnel for assistance or information about device configuration.

ENTERING SETUP OPTIONS

To enter the SETUP menu:

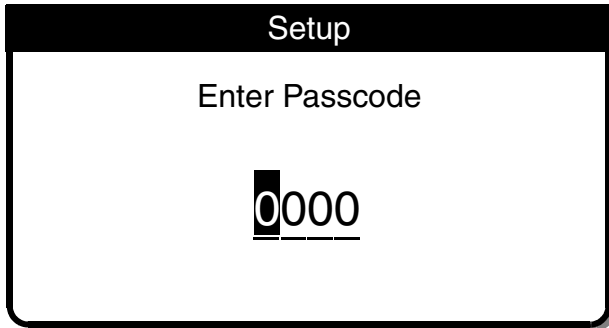

- 1 Press ON while holding down OPTIONS and EVENT. Continue to hold these controls down until the PASSCODE screen appears.
- 2 Enter the passcode by scrolling through the digits in the highlighted fields.
- 3 Select the digit. The digit changes to a dot to protect the passcode. If you enter the correct digit, the next number in line highlights automatically.

Note: When you have entered the correct passcode, the SETUP overlay appears. If you enter the passcode incorrectly, the message **PASSCODE INCORRECT—TRY AGAIN** appears in the status message area. You have three chances to enter the passcode correctly. Cycle power to start again.

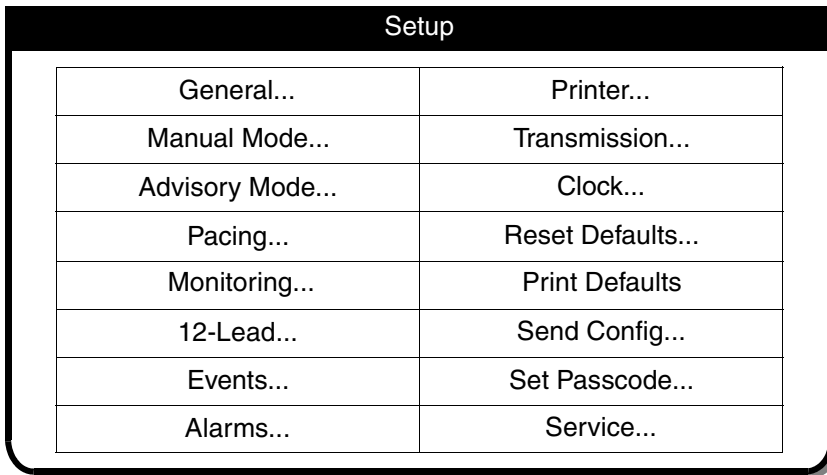

Figure 9-1 SETUP screen

GENERAL SETUP MENU

The General Setup menu allows you to configure general purpose functions. When you select an item from the menu, a help message displays. The options in **bold** are the factory defaults. Pressing HOME SCREEN after selecting a menu item returns you to the SETUP screen.

Table 9-1 General Setup Menu

Menu Item	Help Message	Options
LANGUAGE	Language used for all messages, prompts	Options are: ENGLISH , FRENCH, GERMAN, SPANISH, SWEDISH, ITALIAN, DUTCH, FINNISH, DANISH, NORWEGIAN, POLISH, and PORTUGUESE.

Defining Setup Options

Table 9-1 General Setup Menu (Continued)

Menu Item	Help Message	Options
CODE SUMMARY	CODE SUMMARY Formats	Options are: SHORT, MEDIUM, LONG (refer to page 6-3).
TREND SUMMARY	Include Trend Summary with Code Summary [printing]	OFF ON
SITE NUMBER	Site ID Number	Prints on reports. 0-9 , A-Z available. Maximum 14 digits.
DEVICE NUMBER	Device ID Number	Prints on reports. 0-9 , A-Z available. Maximum 14 digits.
AUTO LOG	Auto vital sign capture every 5 minutes	ON : Vital sign data entered into Event/Vital sign log every 5 minutes. OFF : Vital sign entered only when events occur.
LINE FILTER	Line filter center frequency	50 or 60Hz .
TIMEOUT SPEED	Delay before a menu is dismissed	Time that menus stay on screen (30 , 10, or 5 seconds). (Pacing, 12-lead/Age, and Transmit menus are fixed at 30 seconds.)

MANUAL MODE SETUP MENU

The Manual Mode Setup menu allows you to configure defibrillation and synchronized cardioversion defaults. When you select an item from the menu, a help message displays. The options in **bold** are the factory defaults.

Table 9-2 Manual Mode Setup Menu

Menu Item	Help Message	Options
SYNC AFTER SHOCK	Resume sync after energy transfer	ON : Defibrillator returns to sync after energy transfer. OFF : Defibrillator returns to asynchronous mode.
PADS DEFAULT	Default energy for paddles or QUIK-COMBO™ electrodes	Power-on energy setting for standard paddles and therapy electrodes: 2, 5, 10, 50, 100, 125, 150, 175, 200 , 225, 250, 275, 300, 325, 360 (joules), or Energy Protocol. Note : Auto energy sequences are disabled if you press the ENERGY SELECT control or change to or from AED mode during use.

Table 9-2 Manual Mode Setup Menu (Continued)

Menu Item	Help Message	Options
ENERGY PROTOCOL...	Energies for energy protocol	<p>ENERGY 1: Full range: 100, 125, 150, 175, 200, 225, 250, 275, 300, 325, 360</p> <p>ENERGY 2: Full range: 100, 125, 150, 175, 200, 225, 250, 275, 300, 325, 360</p> <p>ENERGY 3: Full range: 100, 125, 150, 175, 200, 225, 250, 275, 300, 325, 360</p> <p>Note: ENERGY 2 can not be less than ENERGY 1. ENERGY 3 can not be less than ENERGY 2.</p> <p>Note: To activate, select ENERGY PROTOCOL in the PADS DEFAULT menu.</p> <p>Note: Auto energy sequences are disabled if you press the ENERGY SELECT control or change to or from AED mode during use.</p>
INTERNAL DEFAULT	Default energy for internal paddles	Power-on energy setting for internal paddles: 2, 5, 10 , 20, 30, or 50.
VOICE PROMPTS	Voice prompts active in Manual Mode	ON: Voice prompts active. OFF: Voice prompts inactive.
SHOCK TONE	Tone when defibrillator is fully charged	ON: A tone sounds. OFF: No tone.
MANUAL ACCESS	Means for accessing Manual Mode	<p>DIRECT: No restrictions to manual mode.</p> <p>CONFIRMED: Confirmation required to gain manual access.</p> <p>PASSCODE: Passcode required to enter manual mode.</p> <p>RESTRICTED: Manual mode access is denied. Manual/Direct, AED/Direct, AED/Confirm Once, AED/Confirm Always, AED/Passcode Once, AED/Passcode Always, AED/Restricted.</p>
SET PASSCODE...	Passcode required to enter Manual Mode	<p>If configured for passcode access.</p> <p>None: Default passcode enabled.</p> <p>New: User-defined 4-digit code enabled.</p>

AED MODE SETUP MENU

The AED Mode Setup menu allows you to define automated external defibrillator (AED) settings. When you select a menu item, the screen displays a help message describing the option. The options in **bold** are factory default settings and are consistent with 2005 American Heart Association (AHA) and European Resuscitation Council (ERC) guidelines. Refer to Appendix G for more detailed description of CPR setup options.

Table 9-3 AED Mode Setup Menu

Menu Item	Help Message	Options
ENERGY PROTOCOL	Sequence of defibrillation energies	ENERGY 1: Full range: 150, 175, 200 , 225, 250, 275, 300, 325, 360 ENERGY 2: Full range: 150, 175, 200, 225, 250, 275, 300 , 325, 360 ENERGY 3: Full range: 150, 175, 200, 225, 250, 275, 300, 325, 360
	Enable consecutive shocks without CPR	STACKED SHOCKS: ON or OFF . Note: ENERGY 2 cannot be less than ENERGY 1. ENERGY 3 cannot be less than ENERGY 2. Note: 150, 175 joules not available in Japan.
VOICE PROMPTS	Voice prompts on in AED Mode	ON: Voice prompt active. OFF: Voice prompt inactive.
AUTO ANALYZE	Select Auto Analyze options	AFTER 1ST SHOCK: The second and third rhythm analyses of each three-shock stack start automatically. (Stacked Shocks must be set to ON.) OFF: Auto analyze inactive.
MOTION DETECTION	Alert when motion is detected	ON or OFF .
CPR...	Set CPR options for AED Mode	
PULSE CHECK	Enable Pulse Check prompt	ALWAYS: After every stack of shocks and every NSA finding. AFTER EVERY NSA: Only after NO SHOCK ADVISED. AFTER SECOND NSA: After every NSA except for first analysis NSA result. NEVER: Never prompt for PULSE CHECK.
INITIAL CPR	Enable Initial CPR	OFF , ANALYZE FIRST, CPR FIRST
INITIAL CPR TIME	Set CPR interval for initial CPR	15, 30, 45, 60, 90, 120 , 180 Seconds
PRESHOCK CPR	Set CPR interval after shock advised decisions	OFF , 15, 30 Seconds
CPR TIME 1	Set CPR interval after shocks	15, 30 45, 60, 90, 120 , 180 Seconds, or 30 Minutes
CPR TIME 2	Set CPR interval after No Shock Advised	15, 30 45, 60, 90, 120 , 180 Seconds, or 30 Minutes

PACING SETUP MENU

The Pacing Setup menu allows you to configure noninvasive pacemaker defaults. When you select an item from the menu, a help message displays. The options in **bold** are the factory defaults.

Table 9-4 Pacing Setup Menu

Menu Item	Help Message	Options
RATE	Default pacing rate	40–170, 60 .
CURRENT	Default pacing current	0 –200 mA.
MODE	Default pacing mode	DEMAND or NONDEMAND.
INTERNAL PACER	Detect internal pacemaker and print arrows*	DETECTION OFF or DETECTION ON.

* Looks at lead II if available. If lead II is not available, looks at lead V₄ to detect presence of internal pacemaker pulses.

MONITORING MENU

Use the Monitoring menu to configure defaults for the ECG, SpO₂, NIBP, EtCO₂ and IP monitoring. When you select an item from the menu, a help message displays. The options in **bold** are the factory defaults.

Table 9-5 Monitoring Menu

Menu Item	Help Message	Options
CHANNELS...	Set up default channel waveform	See Table 9-6.
ECG...	Continuously store ECG waveform	ON or OFF.
SPO2 TONE	SpO ₂ pulse tone	ON or OFF .
CO2...	Set up CO ₂ defaults	
NIBP...	Set up NIBP defaults	
INVASIVE PRESSURE...	Set up invasive pressure units	mmHg or kPa.
TRENDS...	Vital signs and ST monitoring	ON or OFF.*

* If the monitor is used on a patient with TRENDS configured OFF and then after the patient use, TRENDS is configured ON, the patient's reports in archive mode will show Trend Summary as a selection, but no trend data will be available.

Channels Setup Menu

To configure the default set and up to 5 optional waveform sets for channels 1, 2 and/or 3, choose from the Channels Setup Menu.

Table 9-6 Channels Setup Menu Waveform Sets Setup Menu

Menu Item	Help Message	Options
DEFAULT SET	Select default waveform set	Set 1 , Set 2, Set 3, Set 4, or Set 5.
SET 1	Select channel waveforms for Set 1	See Table 9-7.
SET 2	Select channel waveforms for Set 2	See Table 9-7.
SET 3	Select channel waveforms for Set 3	See Table 9-7.
SET 4	Select channel waveforms for Set 4	See Table 9-7.
SET 5	Select channel waveforms for Set 5	See Table 9-7.

Waveform Sets Setup Menu

Table 9-7 Waveform Sets Setup Menu

Menu Item	Help Message	Options ¹
CHANNEL 1 ^{2 3}	Select waveform for channel 1	Paddles, ECG Lead I, ECG Lead II , ECG Lead III, (AVR, AVL, AVF, V1, V2, V3, V4, V5, V6).
CHANNEL 2	Select waveform for channel 2	NONE , Cascading ECG, ECG Lead I, ECG Lead II, ECG Lead III, (AVR, AVL, AVF, V1, V2, V3, V4, V5, V6), CO2, SpO2, P1, P2.
CHANNEL 3	Select waveform for channel 3	NONE , ECG Lead I, ECG Lead II, ECG Lead III, (AVR, AVL, AVF, V1, V2, V3, V4, V5, V6), CO2, SpO2, P1, P2.

¹ Only available leads appear as options.

² When a 3-lead cable is used, channel 1 will display only ECG leads I, II, or III even if any other lead (except paddles lead) is configured in setup.

³ Paddles in channel 1 will suppress ECG lead selections in channels 2 and 3.

CO2 Setup Menu

Table 9-8 CO2 Setup Menu

Menu Item	Help Message	Options
UNITS	Set up CO2 units	mmHg , kPa, or %.
BTPS	Body temperature compensation	ON or OFF .

NIBP Setup Menu

Table 9-9 NIBP Setup Menu

Menu Item	Help Message	Options
UNITS	Set up NIBP units	mmHg or kPa.
INIT PRESSURE	Set up initial default cuff pressure	100, 120, 140, 160 , or 180.
INTERVAL	Set up default NIBP interval	OFF , 2, 3, 5, 10, 15, 30, or 60.

12-LEAD SETUP MENU

Use the 12-Lead Setup menu to configure defaults for 12-lead acquisition. When you select an item from the menu, a help message displays. The options in **bold** are the factory defaults.

Table 9-10 12-Lead Setup Menu

Menu Item	Help Message	Options
AUTO TRANSMIT	Transmit data or fax automatically on acquisition	OFF , Auto data or auto fax.
AUTO PRINT	Print automatically on acquisition	ON or OFF.
PRINT SPEED	Print speed for 3-channel 12-lead report	25 mm/sec or 50 mm/sec.
INTERPRETATION	Print 12-lead interpretation	ON or OFF.
ACUTE MI	Print Acute MI message	ON : Prints on the 12-lead reports when criteria are met. OFF: If print interpretation is OFF, this option is off.
PRE/POST DATA	Pre or post acquisition of 12-lead data	PRE: Acquires data previous to button press. POST : Acquires data after button press.
FORMAT	Set print format for 12-lead reports	3-CHANNEL STANDARD . 4-CHANNEL STANDARD. 3-CHANNEL CABRERA. 4-CHANNEL CABRERA.
ISCHEMIA*	Set thresholds for Ischemia detection	THRESHOLD 1 . Threshold 2. OFF. If Acute MI is OFF, this option is off.
PTCA**	Print PTCA message	ON or OFF If print interpretation is OFF, this option is off.
PTCA THRESHOLD (UM)**	Set threshold for PTCA message	500, 600, 700, 800, 900, 1000, 1100, 1200, 1300, 1400, 1500 , 1600, 1700, 1800, 1900, 2000
PREVIOUS PAGE	Go back to previous page	

* Feature is nonfunctional and not available.

** Available only with the Reperfusion Advisory Algorithm enabled.

EVENTS SETUP MENU

Use the Events Setup menu to configure or create user-annotated events. When you select an item from the menu, a help message displays.

Table 9-11 Events Setup Menu

Menu Item	Help Message	Options
EVENTS PAGE 1...	Select events for Page 1	Select events 2 to 9 from a preconfigured list.
EVENTS PAGE 2...	Select events for Page 2	Select events 10 to 18 from a preconfigured list.
CUSTOM EVENTS...	Create custom events to use in event screen	Create up to 16 event names for inclusion in the preconfigured list. Note : Resetting to defaults deletes custom list.

ALARMS SETUP MENU

The **ALARMS Setup** menu allows you to configure alarms and set the alarm volume level. When you select an item from the menu, a help message displays. The options in **bold** are the factory defaults.

Table 9-12 Alarms Setup Menu

Menu Item	Help Message	Options
VOLUME	Set volume for alarms, tones and voice prompts	Select volume level from gradient display. The minimum setting reduces but does not silence alarms.
ALARMS	Enable or disable parameter alarms at power up	ON : Enables alarms for Heart Rate, SpO ₂ , NIBP, EtCO ₂ (except Apnea), and P1 and P2 whenever defibrillator is turned on and valid data is available. OFF : Alarms available through ALARMS button.
VF/VT ALARM	Alarms when VF or VT detected	ON : Enables VF/VT alarm whenever defibrillator is turned on. OFF : VF/VT alarm available through ALARMS button.

PRINTER SETUP MENU

The **PRINTER Setup** menu allows you to configure automatic event printing and ECG frequency response. When you select an item from the menu, a help message displays. The options in **bold** are the factory defaults.

Table 9-13 Printer Setup Menu

Menu Item	Help Message	Options
AUTO PRINT...	Specify Auto Print Event	See Table 9-14
ECG MODE	Default ECG frequency response	MONITOR Diagnostic
MONITOR MODE	Default monitor frequency response for printer and display	1–30 HZ or .5–40 Hz
DIAGNOSTIC MODE*	Default diagnostic frequency response for printer	.05–40 HZ or .05–150 Hz
ALARM WAVEFORMS	Store waveforms with alarm events and print with CODE SUMMARY report	ON/OFF
EVENT WAVEFORMS	Store waveforms with user-entered events and print with CODE SUMMARY report	ON/OFF
VITAL WAVEFORMS	Print waveforms with vital signs in CODE-STAT Suite	ON/OFF

* For 12-lead ECG acquisitions only: if 15 years or less (pediatric age) is entered for patient age, the diagnostic frequency response is always .05–150 Hz when the 12-lead ECG is acquired.

Auto Print Setup Menu

Table 9-14 Printer/Auto Print Setup Menu

Menu Item	Help Message	Options
DEFIBRILLATION	Auto print defibrillation events	ON/OFF
PACING	Auto print pacing events	ON/OFF
CHECK PATIENT	Auto print Check Patient events	ON/OFF
SAS	Auto print SAS events	ON/OFF
PATIENT ALARMS	Auto print patient alarms	ON/OFF
EVENTS	Auto print operator annotated events	ON/OFF
INITIAL RHYTHM	Auto print initial rhythm	ON/OFF
PREVIOUS PAGE...	Go back to previous page	Returns to the previous page

TRANSMISSION SETUP MENU

The TRANSMISSION setup menu is the first level menu for setting up the report transmission feature. When you select an item from the menu, a help message displays. The options in **bold** are the factory defaults. For an integrated procedure for setting up the transmit sites, see "Setting Up Transmit Sites" on page 9-19.

Table 9-15 Transmission Setup Menu

Menu Item	Help Message	Options
DATA...	Set up data transmission sites	See Table 9-16.
FAX...	Set up fax transmission sites	See Table 9-23.
DEFAULT	Select default transmission method	This sets the default when you press the TRANSMIT control to DATA or FAX .
PREVIOUS PAGE...	Go back to previous page	Returns to the previous page.

Transmission/Data Setup Menu

The TRANSMISSION/DATA setup menu is a second level menu for setting up the data transmission feature.

Table 9-16 Transmission/Data Setup Menu

Menu Item	Help Message	Options
SITES...	Set up data transmission sites	See Table 9-17.
DEFAULT SITE	Select default destination site	Select any location in list of configured sites.
DEFAULT REPORT	Select default report for data transmission	Sets default report to SNAPSHOT , ALL , CODE SUMMARY , TREND SUMMARY , VITAL SIGNS , 12-LEAD (most recent) , or CONTINUOUS ECG .
PORTS...	Set up output port configurations	See Table 9-19.
PREVIOUS PAGE...	Go back to previous page	Returns to the previous page.

Defining Setup Options

Transmission/Data/Sites Setup Menu

The TRANSMISSION/DATA/SITES setup menu allows you to select data receiving locations, SITE 1 to SITE 19, for entering the transmit destination information. The SITE text changes to reflect the entered site name. For example, SITE 1 might change to GENERAL HOSP.

Table 9-17 Transmission/Data/Sites Setup Menu

Menu Item	Help Message	Description
SITE 1...	[Setup Site]	Displays the SITE setup menu.
SITE 2...	[Setup Site]	Displays the SITE setup menu.
SITE 3...	[Setup Site]	Displays the SITE setup menu.
SITE 4...	[Setup Site]	Displays the SITE setup menu.
SITE 5...	[Setup Site]	Displays the SITE setup menu.
SITE 6...	[Setup Site]	Displays the SITE setup menu.
SITE 7...	[Setup Site]	Displays the SITE setup menu.
SITE 8...	[Setup Site]	Displays the SITE setup menu.
SITE 9...	[Setup Site]	Displays the SITE setup menu.
SITE 10...	PREVIOUS PAGE [Setup Site] [Go to previous page]	Displays the SITE setup menu; Returns to the previous page.

Transmission/Data/Sites/Site 1 Setup Menu

The TRANSMISSION/DATA/SITES/SITE 1 setup menu allows you to configure Site 1, or other selected sites, for data transmission.

Table 9-18 Transmission/Data/sites/site 1 Setup Menu

Menu Item	Help Message	Options
NAME	Enter name for destination site	Up to 14 characters.
PHONE #	Enter phone number for destination site	Up to 14 characters. See "Entering Telephone Number and Prefix Characters" on page 9-19.
PREFIX 1	Enter area code or other prefix to site phone number	Up to 14 characters. See "Entering Telephone Number and Prefix Characters" on page 9-19.
PREFIX 2	Enter area code or other prefix to site phone number	Up to 14 characters. See "Entering Telephone Number and Prefix Characters" on page 9-19.
OUTPUT PORT	Select output port for data transmission	INTERNAL CELL, INTERNAL , EXTERNAL CELL, EXTERNAL, or DIRECT CONNECT.
TEST	Test the connection to this site	Choose NO PREFIX , PREFIX 1, PREFIX 2 to test.
CLEAR	Clear this site from site list	Clear site NAME, PHONE #, and so on.
PREVIOUS PAGE...	Go back to previous page	Return to the previous page.

Transmission/Data/Default Site Setup Menu

The TRANSMISSION/DATA/DEFAULT SITE setup menu allows you to select a configured data site as the default. Your default site selection automatically appears on the TRANSMIT/DATA screen.

Transmission/Data/Default Report Setup Menu

The TRANSMISSION/DATA/DEFAULT REPORT setup menu allows you to select a default report type, ALL, CODE SUMMARY, 12-LEAD (most recent), or CONTINUOUS ECG. Your default report selection automatically appears in the TRANSMIT/DATA screen.

Transmission/Data/Ports Setup Menu

The TRANSMISSION/DATA/PORTS setup menu allows you to configure defaults for the data transmission ports.

Table 9-19 Transmission/Data/Ports Setup Menu

Menu Item	Help Message	Options
INTERNAL CELL...	[Setup internal cellular modem]	EDIT STRING 1-4, CLEAR, and PREVIOUS PAGE.
INTERNAL...	[Setup internal modem]	EDIT STRING 1-4, CLEAR, and PREVIOUS PAGE.
DIRECT CONNECT...	[Setup direct connection using system connector]	BAUD RATE, PREVIOUS PAGE.
EXTERNAL CELL...	[Setup external cellular modem]	INIT STRING, BAUD RATE, PREVIOUS PAGE.
EXTERNAL...	[Setup external modem]	INIT STRING, BAUD RATE, PREVIOUS PAGE.
PREVIOUS PAGE...	[Go back to previous page]	Returns to the previous page.

Transmission/Data/Ports/Internal Cell Setup Menu

The TRANSMISSION/DATA/PORTS/INTERNAL CELL setup menu allows you to configure the port for cellular data transmission with an internal PC Card modem. For initialization string information, see "Setting Up Transmit Sites" on page 9-19. Table 9-20 shows the Internal Modem Menu Items.

Transmission/Data/Ports/Internal Setup Menu

The TRANSMISSION/DATA/PORTS/INTERNAL setup menu allows you to configure the port for landline data transmission with an internal PC Card modem. For initialization string information, see "Setting Up Transmit Sites" on page 9-19. Table 9-20 shows the Internal Modem Menu Items.

Table 9-20 Transmission/Data/Ports Setup Menu (for Internal and Internal Cell Modems)

Menu Item	Help Message	Description
EDIT STRING 1	Change first init string	Enter the first initialization character string.*†
EDIT STRING 2	Change second init string	Enter the second initialization character string.*†
EDIT STRING 3	Change third init string	Enter the third initialization character string.*†
EDIT STRING 4	Change fourth init string	Enter the fourth initialization character string.*†
CLEAR	Clear init strings	Clears all the initialization character strings.
PREVIOUS PAGE	Go back to previous page	Returns to the previous page.

* **Note:** For ease in editing, press:
 • PRINT – to delete a character
 • TRANSMIT – to insert a blank
 • CODE SUMMARY – to back up one space

† **Note:** Contact your Physio-Control representative at 1.800.442.1142 for the initialization string appropriate for your modem.

Transmission/Data/Ports/Direct Connect Setup Menu

The TRANSMISSION/DATA/PORTS/DIRECT CONNECT setup menu allows you to configure the device System Interface port baud rate for a direct connection between the System Connector and a Personal Computer (PC) or other data processing equipment. The connection baud rate is fixed at 38400.

Table 9-21 Transmission/Data/Ports/Direct Connect Setup Menu

Menu Item	Help Message	Options
BAUD RATE	Select baud rate	Set at 38400. No other options.
PREVIOUS PAGE	Go back to previous page	Returns to the previous page.

Transmission/Data/Ports/External Cell Setup Menu

The TRANSMISSION/DATA/PORTS/EXTERNAL CELL setup menu allows you to configure the port for cellular data transmission with an external modem connected to the System Connector. While supported by the device, this transmission method is not recommended.

Transmission/Data/Ports/External Setup Menu

The TRANSMISSION/DATA/PORTS/EXTERNAL setup menu allows you to configure the port for landline data transmission with an external modem connected to the System Connector. For initialization string information, see "Setting Up Transmit Sites" on page 9-19. Table 9-22 shows the External Modem Menu Items.

Table 9-22 Transmission/Data/Ports/External Modem Setup Menu

Menu Item	Help Message	Options
INIT STRING	Enter initialization strings	Enter the transmission port initialization strings. (See Table 9-20.)
BAUD RATE	Select device to modem baud rate	Select a baud rate 9600, 19200, 38400, 57600 , or 115200.
PREVIOUS PAGE...	Go back to previous page	Returns to the previous page.

Transmission/Fax Setup Menu

The TRANSMISSION/FAX setup menu is a second level menu for setting up the fax report transmission feature.

Table 9-23 Transmission/Fax Setup Menu

Menu Item	Help Message	Options
SITES	Set up fax transmission sites	See Table 9-24.
DEFAULT SITE	Select default destination site	Select any location in list of configured sites.
BAUD RATE	Select default baud rate for fax transmission	2400, 4800, 7200, 9600 , 12000, or 14400.
PORTS...	Set up output port configurations	See Table 9-26.
ORGANIZATION...	Enter organization information to be printed on fax reports	See Table 9-29.
PREVIOUS PAGE...	Go back to previous page	Returns to the previous page.

Transmission/Fax/Sites Setup Menu

The TRANSMISSION/FAX/SITES setup menu allows you to select fax receiving locations, SITE 1 to SITE 19, for entering the transmit destination information. The SITE text changes to reflect the entered site name. For example, SITE 1 might change to GENERAL HOSP.

Table 9-24 Transmission/Fax/Sites Setup Menu

Menu Item	Help Message	Description
SITE 1	[Setup Site]	Displays the SITE setup menu.
SITE 2	[Setup Site]	Displays the SITE setup menu.
SITE 3	[Setup Site]	Displays the SITE setup menu.
SITE 4	[Setup Site]	Displays the SITE setup menu.
SITE 5	[Setup Site]	Displays the SITE setup menu.
SITE 6	[Setup Site]	Displays the SITE setup menu.
SITE 7	[Setup Site]	Displays the SITE setup menu.
SITE 8	[Setup Site]	Displays the SITE setup menu.
SITE 9	[Setup Site]	Displays the SITE setup menu.
SITE 10	[Setup Site] [Go to previous page]	Displays the SITE setup menu. Returns to the previous page.

Transmission/Fax/Sites/Site 1 Setup Menu

The TRANSMISSION/FAX/SITES/SITE 1 setup menu allows you to configure Site 1, or other selected sites, for fax transmission.

Table 9-25 Transmission/Fax/Sites/Site 1 Setup Menu

Menu Item	Help Message	Options
NAME	Enter name for destination site	Up to 14 characters.
PHONE #	Enter phone number for destination site	Up to 14 characters. See "Entering Telephone Number and Prefix Characters" on page 9-19.
PREFIX 1	Enter area code or other prefix to site phone number	Up to 14 characters. See "Entering Telephone Number and Prefix Characters" on page 9-19.
PREFIX 2	Enter area code or other prefix to site phone number	Up to 14 characters. See "Entering Telephone Number and Prefix Characters" on page 9-19.
OUTPUT PORT	Select output port for fax transmission	INTERNAL CELL FAX, INTERNAL FAX , EXTERNAL CELL FAX, or EXTERNAL FAX.
TEST	Test the connection to this site	Choose NO PREFIX, PREFIX 1, PREFIX 2 to test.
CLEAR	Clear this site from site list	Clear site NAME, PHONE #, and so on.
PREVIOUS PAGE...	Go back to previous page	Returns to the previous page.

Transmission/Fax/Default Site Setup Menu

The TRANSMISSION/FAX/DEFAULT SITE setup menu allows you to select a configured fax site as the default. Your default selection automatically appears in the TRANSMIT/FAX screen.

Transmission/Fax/Ports Setup Menu

The TRANSMISSION/FAX/PORTS setup menu allows you to configure defaults for the fax transmission ports.

Table 9-26 Transmission/Fax/Ports Setup Menu

Menu Item	Help Message	Options
INTERNAL CELL FAX	[Setup internal cellular fax modem]	EDIT STRINGS 1-4, CLEAR, and PREVIOUS PAGE.
INTERNAL FAX	[Setup internal fax modem]	EDIT STRINGS 1-4, CLEAR, and PREVIOUS PAGE.
EXTERNAL CELL FAX	[Setup external cellular fax modem]	INIT STRING, BAUD RATE, PREVIOUS PAGE.
EXTERNAL FAX	[Setup external fax modem]	INIT STRING, BAUD RATE, PREVIOUS PAGE.
PREVIOUS PAGE	[Go back to previous page]	Returns to the previous page.

Transmission/Fax/Ports/Internal Cell Fax Setup Menu

The TRANSMISSION/FAX/PORTS/INTERNAL CELL FAX setup menu allows you to configure the port for cellular facsimile transmission with an internal PC Card modem. For initialization string information, see "Setting Up Transmit Sites" on page 9-19. Table 9-27 shows the Internal Modem Menu Items.

Transmission/Fax/Ports/Internal Fax Setup Menu

The TRANSMISSION/FAX/PORTS/INTERNAL FAX setup menu allows you to configure the port for landline facsimile transmission with an internal PC Card modem. For initialization string information, see "Setting Up Transmit Sites" on page 9-19. Table 9-27 shows the Internal Modem Menu Items.

Table 9-27 Transmission/Fax/Ports/Internal Fax Modem Setup Menu

Menu Item	Help Message	Description
EDIT STRING 1	Change first init string	Enter the first initialization character string.*†
EDIT STRING 2	Change second init string	Enter the second initialization character string.*†
EDIT STRING 3	Change third init string	Enter the third initialization character string.*†
EDIT STRING 4	Change fourth init string	Enter the fourth initialization character string.*†
CLEAR	Clear init strings	Clears all the initialization character strings.
PREVIOUS PAGE	Go back to previous page	Returns to the previous page.

* **Note:** For ease in editing, press:

- PRINT – to delete a character
- TRANSMIT – to insert a blank
- CODE SUMMARY – to back up one space

† **Note:** Contact your Physio-Control representative at 1.800.442.1142 for the initialization string appropriate for your modem.

Transmission/Fax/Ports/External Cell Fax Setup Menu

The TRANSMISSION/FAX/PORTS/EXTERNAL CELL FAX setup menu allows you to configure the port for cellular facsimile transmission with an external modem connected to the System Connector. While supported by the device, this transmission method is not recommended.

Transmission/Fax/Ports/External Fax Setup Menu

The TRANSMISSION/FAX/PORTS/EXTERNAL FAX setup menu allows you to configure the port for landline facsimile transmission with an external modem connected to the System Connector. For initialization string information, see "Setting Up Transmit Sites" on page 9-19. Table 9-28 shows the External Modem Menu Items.

Table 9-28 Transmission/Fax/Ports/External Fax Setup Menu

Menu Item	Help Message	Description
INIT STRING	Enter initialization strings	Enter the transmission port initialization strings. (See Table 9-27.)
BAUD RATE	Select device to modem baud rate	Select a baud rate 9600 , 19200, 38400, 57600, or 115200.
PREVIOUS PAGE	Go back to previous page	Returns to the previous page.

Transmission/Fax/Organization Setup Menu

The TRANSMISSION/FAX/ORGANIZATION setup menu allows you to add the sending organization name and telephone number for printing on fax reports. For an example, see Figure 6-6.

Table 9-29 Transmission/Fax/Organization Setup Menu

Menu Item	Help Message	Description
NAME	Enter organization name to be printed on fax reports	Up to 14 characters.
PHONE #	Enter organization phone number to be printed on fax reports	Up to 14 characters.
PREVIOUS PAGE...	Go back to previous page	Returns to the previous page.

CLOCK SETUP MENU

Use the CLOCK setup menu to configure defaults for the time displayed. When you select an item from the menu, a help message displays. The options in **bold** are the factory defaults.

Table 9-30 Clock Setup Menu

Menu Item	Help Message	Options
DATE/TIME...	Set current date and time	Current date active next time at power up.
CLOCK MODE	Real or elapsed time on display	REAL TIME or ELAPSED TIME.
DST	Daylight savings time	ON or OFF .
TIME ZONE...	Select time zone for this device	NONE , or list of 74 time zones with universal time code (UTC).

RESET DEFAULTS SETUP MENU

Use the RESET DEFAULTS menu to configure the device for all factory defaults.

Table 9-31 Reset Defaults Setup Menu

Menu Item	Help Message	Options
CANCEL...	Cancel and return to Setup Screen	Cancels reset operation.
RESET	Resets unit setup to factory defaults (no recovery)	Resets setup parameters to the factory defaults, except for transmission sites, output ports, initialization strings, and the maintenance interval, which remains unchanged.

PRINT DEFAULTS

Use the PRINT DEFAULTS menu item to print out the current device configuration setup.

SEND CONFIGURATION SETUP MENU

Use the SEND CONFIG menu to transfer this device setup configuration to overwrite the setup configuration in another biphasic LIFEPAK 12 defibrillator/monitor with software version -130 or higher. You can send configurations between devices with different features (for example, NIBP) but you cannot transfer setup configuration between biphasic and monophasic defibrillators or devices with different versions of operating software because the setup menus may not be identical. If for any reason the transfer of configuration is interrupted, cycle the power on each device and resend the configuration setup.

Table 9-32 Send Configuration Setup Menu

Menu Item	Help Message	Options
SEND	Send device configuration to another device	Connect devices with a cable (PN 3011538), display this screen on both devices, then SEND.
PREVIOUS PAGE	Go back to previous page	Cancels the operation.

SET PASSCODE SETUP MENU

Use the PASSCODE menu to change the factory default passcode of 0000 to some other number. If you lose the Setup Passcode, you will have to telephone the factory for assistance.

Table 9-33 Set Passcode Setup Menu

Menu Item	Help Message	Options
SETUP MODE	(The current passcode appears.) Set passcode to enter setup mode.	Rotate the speed dial to select digits.
ARCHIVES ACCESS	Select passcode access for archives mode.	NO PASSCODE , ARCHIVES ONLY, DELETE ONLY, ARCHIVES/DELETE.
ARCHIVES MODE	Set passcode to enter archives mode.	Rotate the speed dial to select digits.
DELETE RECORDS	Set passcode to delete records in archives mode.	Rotate the speed dial to select digits.
PREVIOUS PAGE	Go back to previous page.	Cancels the operation.

SERVICE MODE

The service mode contains tests and logs intended for service personnel. For specific information concerning access to the service mode, refer to the *LIFEPAK 12 Defibrillator/Monitor Service Manual*.

ENTERING TELEPHONE NUMBER AND PREFIX CHARACTERS

Table 9-34 shows you the characters used for the DATA and FAX site telephone/prefix numbers, while Figure 9-2 shows you several examples. The telephone number consists of the PHONE # plus two separate prefix choices, PREFIX 1 and PREFIX 2.

Table 9-34 AT Command Dialing Prefix Characters

Character	Description
0 to 9	Touch tone and pulse dial characters
A to D plus * and #	Extended touch tone dial characters
P, T, W	Pulse dialing; Touch Tone dialing; Wait for second dial tone
,	Wait 2 seconds before continuing
@	Wait for Quiet Answer (5 seconds of silence after answering) before continuing
! = ; : ^ +	Other characters
DELETE, INSERT SPACE	Delete a character; Insert a space character

Transmission / Data / Sites / Site 1

Enter name for destination site

Name	GEN HOSPITAL
Phone #	8675555
Prefix 1	9,,1425
Prefix 2	1425
Output Port	Internal Cell
Test	No Prefix
Clear	
Previous Page...	

During device operation, when you press TRANSMIT then DATA or FAX, you have a choice of transmitting using just the PHONE #, or the Phone # preceded by PREFIX 1 or PREFIX 2.

Phone #	9W12064258242
Prefix 1	
Prefix 2	

No Prefix: Dial 9, wait for a second dial tone, then dial 1 (206) 425-8242.

Phone #	4258242@1756
Prefix 1	1509
Prefix 2	1

Prefix 1: Dial 1 (509) 425-8242, wait for Quiet Answer, then dial extension 1756.
 Prefix 2: Dial 1 425-8242, wait for Quiet Answer, then dial extension 1756.

Figure 9-2 Transmission Site Telephone Number/Prefix Examples

SETTING UP TRANSMIT SITES

You can configure up to 19 data transmission sites, and 19 fax transmission sites if the fax option is installed. This procedure assumes you are using an internal PC Card modem installed in the device PC Card slot, an external modem connected to the device System Connector or a direct connection cable PN 3009817-00 connected to the System Connector. Connection drawings are shown in Figure 6-3 through Figure 6-6.

Defining Setup Options

To set up a transmit site:

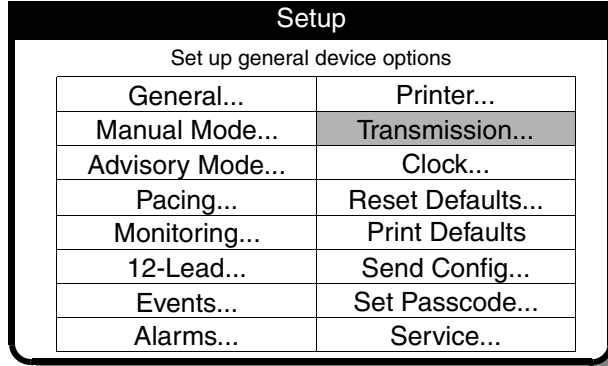

- 1 **Enter Setup Mode** Hold down the **OPTIONS** and **EVENT** controls then turn on the device.
- 2 Enter the Setup Mode passcode to display the **SETUP** menu. The default passcode is 0000. If this passcode fails, the default passcode has been changed. In this case, obtain the current passcode from a responsible party.
- 3 Select **TRANSMISSION** from the **SETUP** menu.

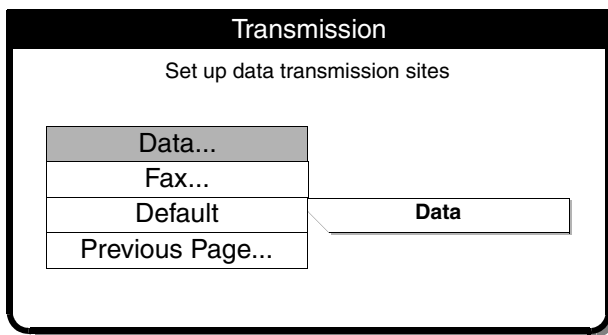

- 4 **Select Data or Fax** Select **DATA** to set up the data sites or **FAX** to set up the fax sites. (This procedure uses **DATA** as an example.)

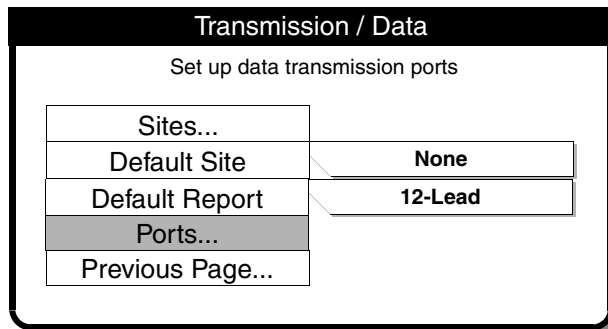

- 5 **Select Ports** Select **PORTS** to access the desired modem port.

The LIFEPAK 12 defibrillator/monitor uses any of the following connection ports for a transmission:

- **Internal Cell** Transmit reports by cellular telephone using an internal PC Card modem.
- **Internal** Transmit reports by landline telephone using an internal PC Card modem.
- **External** Transmit reports by landline telephone using an external modem.
- **External Cell** Not recommended.
- **Direct Connect** Transmit reports directly to a PC using a serial port interface cable.

These ports (except Direct Connect) use a default initialization string that is generic to most modems.

To modify the initialization string, enter it as follows:

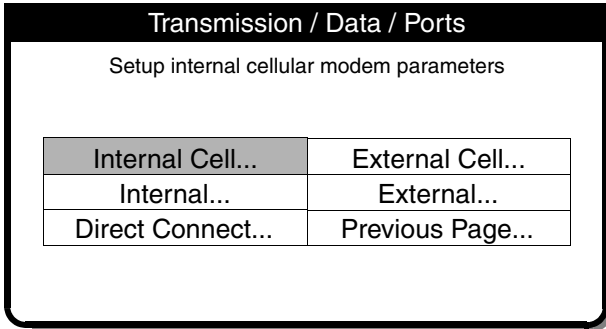

- 6 Select a port type** Select the modem port you will use for transmission:
 INTERNAL CELL Select, then go to Step 9.
 – or –
 INTERNAL Select, then go to Step 9.
 – or –
 EXTERNAL Select, then go to Step 7.

- Notes:**
 a. EXTERNAL CELL is not recommended.
 b. DIRECT CONNECT is fixed at a rate of 38,400 baud and there is nothing to set up.

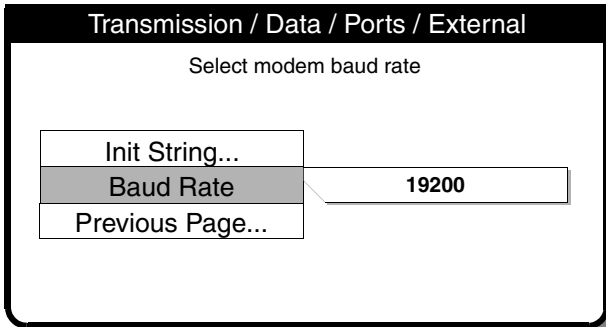

- 7 Baud Rate** Select a BAUD RATE of 19200, or a baud rate compatible with your external modem.
8 Select INIT STRING and go to Step 9.

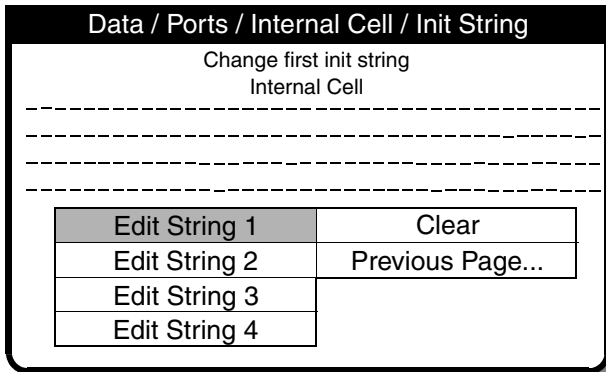

- 9 Init Strings** Initialization strings are subject to change as communication technology advances.
10 Enter the initialization string indicated on the Physio-Control Web page for your modem.
11 Select END to move to the next entry.
12 Select PREVIOUS PAGE repeatedly until returned to the TRANSMISSION/DATA menu.

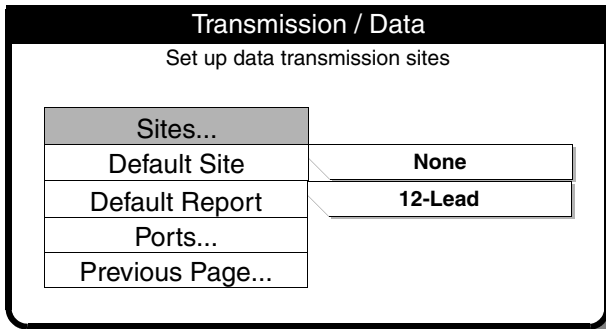

- 13** Select SITES to set up a transmission site.

Defining Setup Options

Transmission / Data / Sites	
Site 1...	Site 11...
Site 2...	Site 12...
Site 3...	Site 13...
Site 4...	Site 14...
Site 5...	Site 15...
Site 6...	Site 16...
Site 7...	Site 17...
Site 8...	Site 18...
Site 9...	Site 19...
Site 10...	Previous Page...

14 **Select Site** Choose SITE 1 or any available site.

Transmission / Data / Sites / Site 1	
Name	GEN HOSPITAL
Phone #	8675555
Prefix 1	9,,1425
Prefix 2	1425
Output Port	Internal Cell
Test	No Prefix
Clear	
Previous Page...	

15 **Set up Site** Select CLEAR to remove previous information (if any), then select each heading and enter information. Select END to move to the next entry.

- Name – Site name
- Phone – Site telephone number
- Prefix 1 – Prefix 1 if you need an area code or an outside line
- Prefix 2 – Prefix 2 if you need an area code or an outside line
- Output Port – Select the port you will use for transmission. If DIRECT CONNECT is selected as the output port, it is not necessary to enter a telephone number or prefix; only a name.
- Test – see Step 18.

Transmission / Data	
Set up data transmission sites	
Sites...	
Default Site	GEN HOSP RM 16
Default Report	GEN HOSP RM 34
Ports...	HARBORVIEW ER
Previous Page...	CITY HOSP ER
	SWEDISH RM 202
	PACIFIC HOSP 1
	PACIFIC HOSP 2
	PACIFIC HOSP 3

16 **Select a Default Site** Select PREVIOUS PAGE... to return to the TRANSMSSION/DATA menu. Select DEFAULT SITE to display a list of configured transmission sites. Choose the desired default transmit site. It is this site that appears when you press the TRANSMIT control.

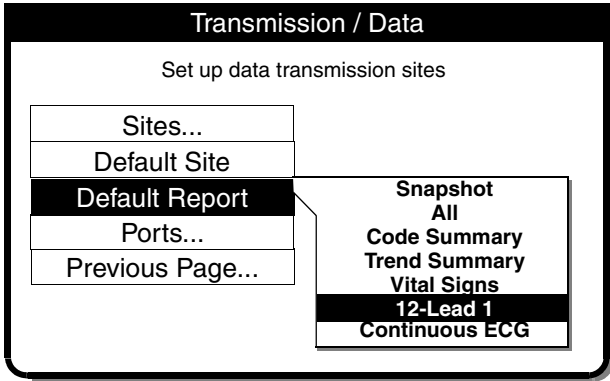

17 Select a Default Report Select **DEFAULT REPORT** to display a list of report choices. Choose the desired default report:

SNAPSHOT – Sends the Snapshot report

ALL – Sends all reports on the list

CODE SUMMARY – Sends the Critical Event report.

TREND SUMMARY – Sends the Trend Summary report

VITAL SIGNS – Sends the Vital Signs report

12-LEAD – Sends the selected 12-Lead report

CONTINUOUS ECG – Sends the Continuous ECG report

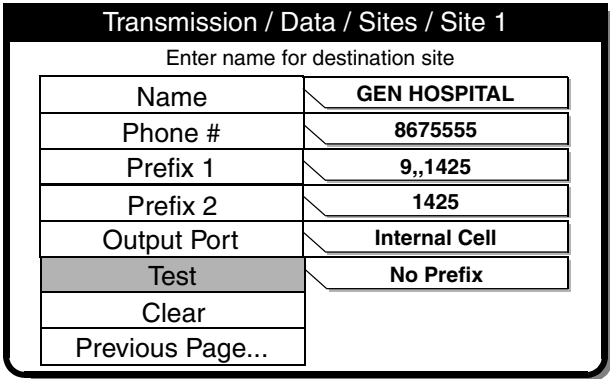

18 Test Site To skip this step, go to Step 19. To test a site, connect the device for communications, then select **SITES** to return to the **TRANSMISSIONS/ DATA/SITES** menu. Select the site you wish to test, then select **TEST**. Choose **NO PREFIX**, **PREFIX 1**, or **PREFIX 2**, as desired, to launch the test. At the end of a successful test, the message **TRANSMISSION COMPLETED** is displayed.

19 To set up or test another site, select **PREVIOUS PAGE** and go to Step 14. If this is the last site to configure, select **PREVIOUS PAGE** until returned to the **TRANSMISSION** menu.

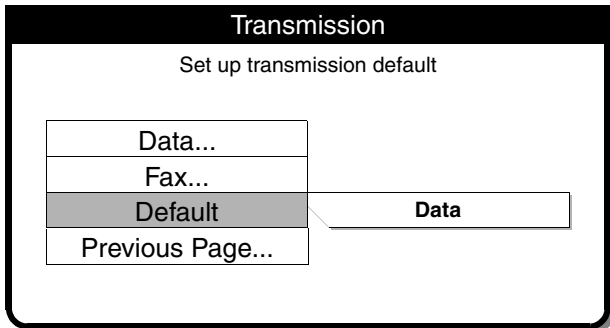

20 Select **DEFAULT** and choose the desired transmit default (for example, **DATA**).

21 Turn off the device.

APPENDIX A SPECIFICATIONS AND PERFORMANCE CHARACTERISTICS

Table A-1 LIFEPAK 12 Defibrillator/Monitor Specifications

Table A-2 AC Power Adapter Specifications

Table A-3 FASTPAK and LIFEPAK Battery Specifications

Table A-4 Performance Characteristics

Table A-5 Cumulative Success Rates and Crossover Results for Cardioversion of AF

Table A-6 Energy Settings, Delivered Energy and Peak Current for Shocks Delivered to Patients in AF

Table A-7 Cumulative Shock Success Rates and Crossover Shock Results for Intra-operative Defibrillation

SPECIFICATIONS AND PERFORMANCE CHARACTERISTICS

Table A-1 lists the specifications for the device.

Table A-2 lists the specifications for the AC Power Adapters that service batteries for the LIFEPAK 12 defibrillator/monitor.

Table A-3 lists the specifications for the LIFEPAK batteries that support the LIFEPAK 12 defibrillator/monitor.

Table A-4 lists performance characteristics of the LIFEPAK 12 defibrillator/monitor in conformance to AAMI requirements for defibrillators, external pacemakers, monitors, and others.

Table A-1 LIFEPAK 12 Defibrillator/Monitor Specifications

All specifications are at 20°C unless otherwise stated.

GENERAL

The LIFEPAK 12 defibrillator/monitor has six main operating modes:

Advisory Mode (SAS)	Provides all features available except manual defibrillation, synchronous cardioversion, pacing, and access to previous patient records.
Manual Mode	Provides normal operating capability for ALS users.
Archive Mode	Allows operator to transmit, print, edit, or delete previous patient records.
Setup Mode	Allows operator to configure the instrument.
Service Mode	Allows operator to execute device diagnostic tests and calibrations.
Inservice Mode	Provides simulated waveforms and trend graphs for demonstration purposes.

POWER

Battery Only Configuration	Choice of NiCd (FASTPAK or FASTPAK 2 battery ¹ , LIFEPAK NiCd battery 1.7 Ah ² or 2.4 Ah ³) or SLA (LIFEPAK SLA battery) Dual battery capability Optional external AC Power Adapter Batteries charge while device operates from Power Adapter
----------------------------	------------------------------------------------------------------------------------------------------------------------------------------------------------------------------------------------------------------------------------------------------------------------------------------

Operating Time

Two new fully charged batteries will provide the following prior to shutdown:

		-----total-----				-----after low battery-----			
		Typical		Min.		Typical		Min.	
Display type		LCD	EL	LCD	EL	LCD	EL	LCD	EL
Monitoring (minutes):	NiCd ¹	110	81	60	43	10	6	2	1
	NiCd ²	155	114	85	62	14	8	2	1
	NiCd ³	220	162	120	86	20	12	4	2
	SLA	180	132	100	73	16	10	2	1
Defibrillation (360 Joule discharges):	NiCd ¹	80	72	45	40	7	7	3	3
	NiCd ²	110	99	60	54	10	10	3	3
	NiCd ³	160	144	90	80	14	14	6	6
	SLA	145	131	85	76	12	12	3	3

Specifications and Performance Characteristics

Monitoring Plus Pacing (minutes at 100 mA, 60 ppm):	NiCd ¹	105	75	60	42	9	6	2	1
	NiCd ²	145	104	85	60	12	8	2	1
	NiCd ³	210	150	120	84	18	12	4	2
	SLA	170	122	100	71	14	10	2	1
Low Battery Indication and Message	Low battery icon at top of display and low battery message in status area for each battery. When low battery is indicated, device autoswitches to second battery. When both batteries reach a low battery condition, there is a voice prompt to replace battery.								
Warmstart	With inadvertent loss of power (less than 30 seconds), the device retains settings.								
A Service Indicator When Error Detected									

PHYSICAL

Physical Characteristics

Weight	Basic defibrillator/monitor with QUIK-COMBO cable: 6.6 kg (14.5 lbs) (unit and QUIK-COMBO cable only – no batteries) Fully featured defibrillator/monitor with QUIK-COMBO cable: 8.0 kg (17.6 lbs) (unit and QUIK-COMBO cable only – no batteries) FASTPAK battery: 0.64 kg (1.4 lbs); FASTPAK 2 battery: 0.64 kg (1.4 lbs); LIFEPAK NiCd battery: 0.8 kg (1.7 lbs); LIFEPAK SLA battery: 1.27 kg (2.8 lbs) With standard paddles (hard): 0.9 kg (1.9 lbs)
Height	31.7 cm (12.5 in)
Width	38.9 cm (15.3 in)
Depth	21.7 cm (8.5 in)
	With connector guard: 0.15 kg (0.3 lbs)
Height	31.7 cm (12.5 in)
Width	39.6 cm (15.6 in)
Depth	23.1 cm (9.1 in)

DISPLAY

Size (active viewing area)	140.8 mm (5.5 in) wide x 105.6 mm (4.2 in) high for LCD, or 165.1 mm (6.5 in) wide x 123.8 mm (4.9 in) high for EL display
Display Type	640 dot x 480 dot black and white LCD or amber and black EL display User selectable display contrast Displays a minimum of 4 seconds of ECG and alphanumeric for values, device instructions, or prompts. Option to display one or two additional waveforms Waveform display sweep speed: 25 mm/sec for ECG, SpO ₂ , IP, and 12.5 mm/sec for CO ₂

DATA MANAGEMENT

The device captures and stores patient data, events (including waveforms and annotations), and continuous ECG waveform records in internal memory

The user can select and print reports and transfer the stored information via an internal modem and various serial transfer protocols

Report Types	<p>Three format types of CODE SUMMARY critical event record (short, medium, and long)</p> <ul style="list-style-type: none"> • Initial ECG (except short format) • Auto vital sign measurements every 5 minutes <p>3-channel or 4-channel 12-lead ECG report</p> <p>Continuous ECG waveform records (transfer only)</p> <p>Trend Summary</p> <p>Vital Signs Summary</p> <p>Snapshot</p>
Memory Capacity	<p>Two full-capacity/patient records that include:</p> <p>CODE SUMMARY critical event record - up to 100 single waveform events</p> <p>Continuous Waveform - 45-minute continuous ECG record</p>

COMMUNICATIONS

The device is capable of transferring data records by PC Card internal modem, external EIA/TIA modem, cellular modem, or serial connection.

Supports EIA/TIA-602 compatible modems using Xon/Xoff or RTS/CTS flow control at 9600-38400 bps.

EIA/TIA-232E compatible at 9600, 19200, 38400, 57600 bps.

Group III, Class 2 or 2.0 facsimile, (wired only).

MONITOR

ECG	<p>ECG is monitored via several cable arrangements. A 3-wire cable is used for 3-lead ECG monitoring. A 5-wire cable is used for 7-lead ECG monitoring. A 10-wire cable is used for 12-lead acquisition. When the chest electrodes are removed, the 10-wire cable functions as a 4-wire cable. Standard paddles or QUIK-COMBO pacing/defibrillation/ECG electrodes or FAST-PATCH disposable defibrillation/ECG electrodes are used for paddles lead monitoring.</p>
Lead Selection	<p>Leads I, II, III, (3-wire ECG cable)</p> <p>Leads I, II, III, AVR, AVL, and AVF acquired simultaneously, (4-wire ECG cable)</p> <p>Leads I, II, III, AVR, AVL, AVF, and C-lead acquired simultaneously, (5-wire ECG cable)</p> <p>Leads I, II, III, AVR, AVL, AVF, V1, V2, V3, V4, V5, and V6 acquired simultaneously, (10-wire ECG cable)</p>
ECG Size	<p>4, 3, 2.5, 2, 1.5, 1, 0.5, 0.25 cm/mV (fixed at 1 cm/mV for 12-lead)</p>
Heart Rate Display	<p>20–300 bpm digital display</p> <p>Accuracy: $\pm 4\%$ or ± 3 bpm, whichever is greater</p> <p>Out of range indication: Display symbol "---"</p> <p>Heart symbol flashes for each QRS detection</p>
QRS Detection Range	<p>Duration: 40 to 120 ms</p> <p>Amplitude: 0.5 to 5.0 mV</p>
Continuous Patient Surveillance System (CPSS)	<p>In advisory mode while Shock Advisory System is not active, CPSS monitors the patient, via QUIK-COMBO paddles or Lead II ECG, for potentially shockable rhythms.</p>

Specifications and Performance Characteristics

Voice Prompts	Used for selected warnings and alarms (configurable on/off).
Analog ECG Output	1V/mV x 1.0 gain
Common Mode Rejection	90 dB at 50/60 Hz
SpO2 (Masimo sensors)	
Saturation range	1 to 100%
Saturation Accuracy	70–100 % (0–69 % unspecified)
Adults/Pediatrics	±2 digits (during no motion conditions) ±3 digits (during motion conditions)
Neonates	±3 digits (during no motion conditions) ±3 digits (during motion conditions)
Dynamic signal strength bar graph	
Pulse tone at the onset of the pleth waveform	
SpO2 Update Averaging Rate	User selectable 4, 8, 12 or 16 seconds
SpO2 measurement	Functional SpO2 values are displayed and stored
Pulse rate range	25 to 240 pulses per minute
Pulse rate accuracy	
Adults/Pediatrics/	±3 digits (during no motion conditions)
Neonates	±5 digits (during motion conditions)
SpO2 waveform with autogain control	
Nellcor sensors when used with MNC-1 adapter	
NIBP	
Blood Pressure	Systolic Pressure range: 30 to 245 mmHg (4 to 32.7 kPa) Diastolic Pressure range: 12 to 210 mmHg (1.6 to 28 kPa) Mean Arterial Pressure range: 20 to 225 mmHg (2.7 to 30 kPa) Units: mmHg, kPa, (user configurable) Blood Pressure Accuracy: maximum mean error of ±5 mmHg (±0.7 kPa) with a standard deviation no greater than ±8 mmHg (±1.1 kPa) Blood pressure measurement: 40 seconds, typical
Pulse Rate	Pulse Rate range: 30 to 200 pulses per minute Pulse Rate accuracy: ±2 pulses per minute or ±2%, whichever is greater
Operation Features	Initial Cuff Pressure: User selectable, 100 to 180 mmHg Automatic Measurement Time Interval: User selectable
Automatic Cuff Deflation	Excessive Pressure: If cuff pressure exceeds 300 mmHg Excessive Time: If measurement time exceeds 120 seconds

CO2

CO2 Range	0 to 99 mmHg (0 to 13.2 kPa) Units: mmHg, kPa, % (user configurable)
CO2 Accuracy (0 to 20 minutes)	0 to 38 mmHg (0 to 5.1 kPa): ± 4 mmHg 39 to 99 mmHg (5.2 to 13.2 kPa): $\pm 12\%$ of reading
CO2 Accuracy (>20 minutes)	0 to 38 mmHg (0 to 5.1 kPa): ± 2 mmHg 39 to 99 mmHg (5.2 to 13.2 kPa): $\pm 5\%$ of reading +0.08% for every 1 mmHg (0.13 kPa) above 38 mmHg
Respiration Rate Range	0 to 60 breaths/minute
Respiration Rate Accuracy	0 to 40 bpm: ± 1 bpm 41 to 60 bpm: ± 2 bpm
Warm up time	30 seconds (typical), 180 seconds maximum
Rise Time	190 ms
Response Time	2.9 seconds (includes delay time and rise time)
Ambient Pressure	Automatically compensated internally
Optional Display Waveform	CO2 Pressure

IP

Transducer Type	Strain-gauge resistive bridge
Transducer Sensitivity	5 μ V/V/mmHg
Excitation Voltage	5Vdc
Connector	Electro Shield CXS 3102A 14S-6S
Bandwidth	Digital filtered, dc to 30 Hz (< -3db)
Zero Drift	1 mmHg/hr without transducer drift
Zero Adjustment	± 150 mmHg including transducer offset
Numeric Accuracy	± 1 mmHg or 2% of reading, whichever is greater, plus transducer error
Pressure Range	-30 to 300 mmHg in six user selectable settings
Pulse Range	Pulse rate not derived from IP, IP monitor functions over the full ECG/SpO2/NIBP HR/PR range of 20–300 bpm
Leakage Current	Meets ANSI/AAMI/IEC leakage requirements
IP Connector Pinout	Counterclockwise from 12 o'clock, viewed from the front of LIFEPAK 12: A pin = -signal; B pin = +excitation; C pin = +signal; D pin = -excitation; E pin = shield; F pin = unlabeled.
Invasive Pressure Display	Display: IP waveform and numerics Units: mmHg, kPa (user configurable) Labels: P1 or P2, ART, PA, CVP, ICP, LAP (user selectable)

TREND

Display	Choice of HR, SpO2 (%), EtCO2, FiCO2, RR, NIBP, P1, P2, STM shown in Channels 2 or 3
Time Scale	Auto, 30 minutes, 1, 2, 4, or 8 hours
Duration	Up to 8 hours with -06 or later Memory PCB. Reduced storage capacity with earlier versions.

Specifications and Performance Characteristics

ST	After initial 12-lead ECG analysis, automatically selects and trends ECG lead with the greatest ST displacement
----	-----------------------------------------------------------------------------------------------------------------

ALARMS

Quick Set	Activates alarms for all parameters
VF/VT Alarm	Activates continuous CPSS monitoring in Manual Mode
Apnea Alarm	Occurs when 30 seconds has elapsed since last detected respiration
Heart Rate Alarm Limit Range	Upper, 100–250 bpm; lower, 30–150 bpm

INTERPRETIVE ALGORITHMS

12-Lead Interpretive Algorithm: GE Medical 12SL, includes AMI statements

PRINTER

	Prints continuous strip of the displayed patient information
Paper Size	50 mm (2.0 in) or optional 100 mm (3.9 in)
Print Speed	25 mm/Sec $\pm 5\%$ (measured in accordance with AAMI EC-11, 4.2.5.2) Optional 50 mm/sec time base for 12-Lead ECG reports
Delay	8 seconds
Autoprint	Waveform events print automatically (user-configurable)

FREQUENCY RESPONSE

Diagnostic Frequency Response	0.05 to 150 Hz or 0.05 to 40 Hz (user-configurable)
Monitor Frequency Response	0.67 to 40 Hz or 1 to 30 Hz (user-configurable)
Paddles Frequency Response	2.5 to 30 Hz
Analog ECG Output Frequency Response	0.67 to 32 Hz (except 2.5 to 25 Hz for Paddles ECG and 1.3 to 23 Hz for 1 to 30 Hz Monitor Frequency Response)

DEFIBRILLATOR

MANUAL

Energy Select (BTE Configuration)	2, 3, 4, 5, 6, 7, 8, 9, 10, 15, 20, 30, 50, 70, 100, 125, 150, 175, 200, 225, 250, 275, 300, 325, and 360 Joules or user-configurable sequence of 100-360 Joules
Charge time	Charge time to 360 Joules in less than 10 seconds, typical.
Synchronous cardioversion	Energy transfer begins within 60 ms of the QRS peak.
Waveform	Biphasic Truncated Exponential The following specifications apply from 25 to 200 Ω , unless otherwise specified. Energy Accuracy: ± 1 joule or 10% of setting, whichever is greater, into 50 Ω ; ± 2 joule or 15% of setting, whichever is greater, into any impedance from 25 Ω - 100 Ω . Voltage Compensation: Active when disposable therapy electrodes are attached. Energy output within $\pm 5\%$ or ± 1 joule, whichever is greater, of 50 Ω value limited to the available energy which results in the delivery of 360 joules into 50 Ω .

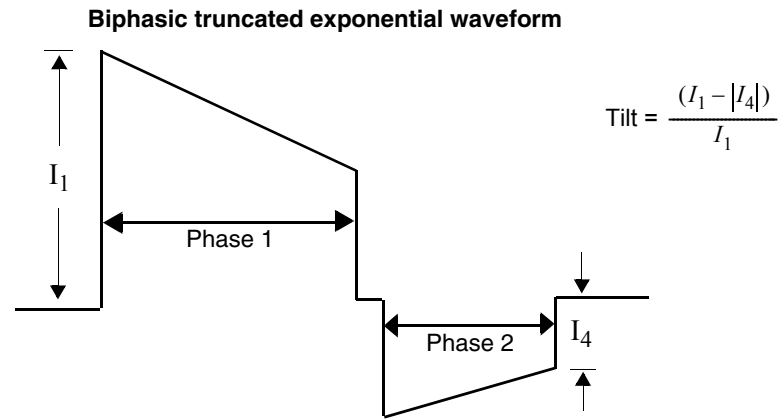

Patient Impedance (Ω)	Phase 1 Duration (ms)		Phase 2 Duration (ms)		Tilt (%)	
	Min	Max	Min	Max	Min	Max
25	5.1	6.0	3.4	4.0	74.8	82.9
50	6.8	7.9	4.5	5.3	63.9	71.0
100	8.7	10.6	5.8	7.1	50.7	56.5
125	9.5	11.2	6.3	7.4	46.3	51.6

Paddle Options	QUIK-COMBO pacing/defibrillation/ECG electrodes (standard) FAST-PATCH disposable defibrillation/ECG electrodes (optional) Standard Paddles (optional) Internal Paddles (optional)
Cable Length	8-foot long QUIK-COMBO cable (not including electrode assembly)
AED MODE	Shock Advisory System (SAS) is an ECG analysis system that advises the operator if the algorithm detects a shockable or nonshockable ECG rhythm. SAS acquires ECG via therapy electrodes only.
Shock Ready Time	Using a fully charged battery at normal room temperature, the device is ready to shock within 20 seconds if the initial rhythm finding is SHOCK ADVISED.
Output Energy (BTE Configuration)	User configurable sequence of three sequential shock levels ranging from 150–360 joules. Note that 150 and 175 joules are not available in Japan.

PACER

Pacing Mode	Demand or non-demand Rate and current defaults (user configurable)
Pacing Rate	40 to 170 ppm
Rate Accuracy	$\pm 1.5\%$ over entire range
Output Waveform	Monophasic, truncated exponential current pulse (20 ± 1.5 ms)
Output Current	0 to 200 mA
Pause	Pacing pulse frequency reduced by a factor of 4 when activated
Refractory Period	200 to 300 ms $\pm 3\%$ (function of rate)

Specifications and Performance Characteristics

ENVIRONMENTAL

Temperature, Operating	0° to 50°C (32° to 122°F) SpO2: 5° to 45°C (41° to 113°F)
Temperature, Non-Operating	-20° to 60°C (-4° to 140°F) except therapy electrodes and batteries
Relative Humidity, Operating	5 to 95%, non-condensing
Atmospheric Pressure, Operating	Ambient to 429 mmHg (0 to 4,572 meters) (0 to 15,000 feet)
Water Resistance, Operating	IPX4 (splash proof) per IEC 60529 (with batteries, hard paddles, and 12-lead ECG cable installed)
Shock (drop)	5 drops on each side from 18 inches onto a steel surface
Vibration	MIL-STD-810E Method 514.4, Propeller Aircraft - category 4 (figure 514.4-7 spectrum a), Helicopter - category 6 (3.75Grms), and Ground Mobile - category 8 (3.14Grms)

Table A-2 AC Power Adapter Specifications

All specifications are at 20°C unless otherwise stated.

FUNCTION

Dimensions	30.7 cm x 16.8 cm x 5.3 cm (12.1 in x 6.6 in x 2.1 in)
Weight	<2.3 kg (<5 lbs) (including cables)
Charge Time (with fully depleted battery)	FASTPAK and FASTPAK 2: 1.5 hours LIFEPAK NiCd: 2.1 hours LIFEPAK SLA: 6 hours typical 12 hours maximum
AC Input	Accepts line power from both: 90–132/198–264Vac, 47–63 Hz (domestic/international) 108–118Vac, 380–420 Hz (military)
Fuses	Two 250V fuses (90–132Vac, 5A Slow Blow), (198–264 Vac, 2.5A Slow Blow) in the power input module

ENVIRONMENTAL

Liquid Ingress	IPX1 per IEC 60529
Altitude, Operating	To 5,468 m (15,000 ft)
Altitude, Non-operating	To 6,578 m (18,000 ft)
Humidity	5 to 95% non-condensing
Temperature, Operating	0° to 50°C (32° to 122°F)
Temperature, Storage	-40° to 71°C (-40° to 158°F) (followed by one hour temperature stabilization in operating temperature range)
Vibration, Operating and Non-operating	MIL-STD-810E, Method 514.4 Categories 4, 6, 8

Table A-3 FASTPAK and LIFEPAK Battery Specifications

All specifications are at 20°C unless otherwise stated.

FASTPAK and FASTPAK 2

Battery Type	Nickel cadmium
Weight	0.7 kg (1.5 lbs)
Voltage	12Vdc
Capacity	1.2 amp hours
Charge Time (with fully depleted battery)	1.5 hours
Conditioning Time in Battery Support System 2	7 hours typical, 8 hours maximum
Charging Temperature Range	5° to 35°C (41° to 95°F)
Operating Temperature Range	0° to 50°C (32° to 122°F)
Long Term (>1 day) Storage Temperature Range	0° to 35°C (32° to 95°F)

LIFEPAK NiCd

Battery Type	Nickel cadmium
Weight	0.9 kg (2.0 lbs)
Voltage	12Vdc
Capacity	1.7 amp hours 2.4 amp hours
Charge Time (with fully depleted battery)	2.25 hours (1.7 Ah) 3.0 hours (2.4 Ah)
Conditioning Time in Battery Support System 2	8 hours typical, 10 hours maximum (1.7 Ah) 9 hours typical, 11 hours maximum (2.4 Ah)
Charging Temperature Range	5° to 35°C (41° to 95°F)
Operating Temperature Range	0° to 50°C (32° to 122°F)
Long Term (>1 day) Storage Temperature Range	0° to 35°C (32° to 95°F)

LIFEPAK SLA

Battery Type	Sealed lead acid
Weight	1.4 kg (3.0 lbs)
Voltage	12Vdc
Capacity	2.5 amp hours
Charge Time (with fully depleted battery)	6 hours typical, 12 hours maximum
Conditioning Time in Battery Support System 2	28 hours typical, 56 hours maximum
Charging Temperature Range	5° to 35°C (41° to 95°F)
Operating Temperature Range	0° to 50°C (32° to 122°F)
Long Term (>1 day) Storage Temperature Range	0° to 35°C (32° to 95°F)

Specifications and Performance Characteristics

Table A-4 Performance Characteristics

CHARACTERISTIC	
Respiration, Leads Off Sensing, Noise Cancellation Current, and Voltage	The ECG leads off function uses DC current for sensing leads off, the disposable defibrillation electrodes use AC current for leads off, and the ECG leads use a noise cancellation signal which ranges from dc to approximately 5k Hz. The amplitude of these signals conforms to AAMI EC-11 3.2.10 and EC-13 3.2.5.
Heart Rate Averaging Method	The heart rate average is formed by a weighted average of approximately 8 seconds duration. When the input rate is trending rapidly, the rate meter will track more quickly. See heart rate response time disclosure. The display update interval is every heartbeat or every 2 seconds, whichever is shorter.
Heart Rate Response Time	Heart rate meter response time: For an 80 to 120 bpm step change, the response time is 2.7 seconds average with a range of 2.2 to 3.5 seconds when tested per AAMI 4.1.2.1 f. For an 80 to 40 bpm step change, the response time is 5.06 seconds with a range of 4.7 to 5.4 seconds.
Heart Rate With Irregular Rhythm	All complexes are detected. The rate meter output can range from the heart rate associated with the shortest R-R interval to the heart rate associated with the longest R-R interval. When present, intermediate length R-R intervals are favored as the basis for the rate.
Heart Rate Alarm Time	In five trials for a 1 mV, 206 bpm tachycardia, the average detection time was 4.6 seconds. The maximum detection time was 5.7 seconds. The minimum time was 3.9 seconds. For a test signal half as large, the average was 4.1 seconds, the maximum was 4.9, and the minimum was 3.2. In this case the device sensitivity was increased to 5mV/cm. For a test signal twice as large, the average was 3.1 seconds, the maximum was 4.0, and the minimum was 2.3. In five trials for a 2 mV, 195 bpm tachycardia, the average detection time was 2.5 seconds. The maximum detection time was 3.3 seconds. The minimum time was 1.5 seconds. For a test signal half as large, the average was 2.2 seconds, the maximum was 2.8, and the minimum was 1.7. In this case the device sensitivity was increased to 5mV/cm. For a test signal twice as large, the average was 1.5 seconds, the maximum was 2.2, and the minimum was 0.75.
Accuracy Of Signal Reproduction	The device is a digital sampled data system. It meets requirements for both test methods for diagnostic frequency response described in EC11 section 3.2.7.2.
Audible Alarms	This is a standalone device. All alarm tones are internal to the LIFEPAK 12 defibrillator/monitor. Alarm violations are manifested by tones, voice prompts, and visual indications. Alarm manifestation occurs within 1 second after a displayed parameter violates its alarm limit. User-selectable alarm volume adjustment is provided. This adjustment does not allow alarm volume to attain/reach a zero level.

CHARACTERISTIC

SAS tones reinforce SAS messages provided on the product display.

The following identifies the tone assignments for each type of alarm:

- The priority 1 tone is used to alert the user to the possibility of imminent death. This tone is a 440 Hz and 880 Hz alternating tone with a 50% duty cycle and a 4 Hz alternation frequency. This tone has a volume of 70 ± 5 dB (A) as measured at a distance of 1 meter from the display.
- The priority 2 tone is used to alert the user that a possible life-threatening condition exists. This tone is a continuous 698 Hz tone.
- The priority 3 tone is used to alert the user that an abnormal condition exists. Three beeps at 1046 Hz for 100 ms duration each with a 150 ms silence between the first and second and the second and third, followed by a 200 ms silence.
Priority 3 tones come in single and repeating types: for a single tone, the 3-beep sequence sounds only once. For a repeating tone, the 3-beep sequence sounds every 20 seconds.
- The priority 4 tone is a momentary tone between 500 and 1500 Hz. Specific characteristics are:
 - QRS and Volume Setting Tone - 100 ms duration at 1397 Hz.
 - Key click - 4 ms duration at 1319 Hz.

The alert tone shall consist of one set of two tones to precede voice prompts and to draw attention to the display. Specific characteristics shall be:

- 1000 Hz square wave, 100 ms duration.
- Silence, 100 ms duration.
- Silence, 140 ms duration (when preceding a voice prompt).
- Voice prompt, when used.

Visual Alarms

Alarms are indicated visually by:

The violated parameter flashes in inverse video with a message in the status region of the display.

These visual indications remain on the display until the alarm is corrected. Visual indication of alarms continue even when the tones have been silenced.

Alarm Silencing

If a violated parameter alarms, the tone may be silenced for two minutes by pressing the Alarms button.

A preemptive alarm silence is provided with selectable settings of 2, 5, 10, and 15 minutes.

Visual alarms remain on at all times.

Specifications and Performance Characteristics

CHARACTERISTIC

VF/VT Alarm	Automatically monitors the patient's ECG rhythm for a potentially shockable rhythm using the Continuous Patient Surveillance System (CPSS). The VF/VT alarm requires that the patient's ECG be monitored in Lead II or Paddles lead using therapy electrodes. The VF/VT alarm will be suspended if pacing is enabled or Standard paddles are connected and Paddles is the displayed lead.
Energy Shunting	If the paddles input is connected in parallel with a second defibrillator, energy delivery to the patient is reduced by less than 15 percent.
Tall T-wave Rejection	T-waves that are 1 mV high are not detected by the monitor when the R-wave size is 1 mV and input rate is 80 ppm.
Charge Time	For battery-only operation (using a fully charged battery): The defibrillator charge time to 360 Joules is less than 10 seconds, following 15 full energy discharges, per IEC 601-2-4. For operation with ACPA: The defibrillator charge time to 360 Joules is less than 10 seconds, at 90% of rated nominal Mains voltage, per IEC 601-2-4.
Defibrillator Energy Accuracy	Energy delivered accuracy $\pm 15\%$ into a 50-ohm load.
Mean Invasive Pressure	Mean pressure is derived by first obtaining a mean value for the pressures in a cardiac cycle of S samples, $\frac{\sum_{n=1}^S IPValues(n)}{S}$, and then calculating a moving average over three cycles.

CLINICAL SUMMARY: DEFIBRILLATION OF VENTRICULAR FIBRILLATION AND VENTRICULAR TACHYCARDIA

Background

Physio-Control conducted a multi-centered, prospective, randomized and blinded clinical trial of biphasic truncated exponential (BTE) shocks and conventional monophasic damped sine wave (MDS) shocks. Specifically, the equivalence of 200J and 130J BTE shocks to 200J MDS shocks¹ was tested.

Methods

Ventricular fibrillation (VF) was induced in 115 patients during evaluation of implantable cardioverter defibrillator function and 39 patients during electrophysiologic evaluation of ventricular arrhythmias. After 19±10 seconds of VF, a customized defibrillator delivered an automatically randomized shock. Efficacy was based on success of this shock. To demonstrate equivalence of test shocks to control shocks, the 95% upper confidence limit of the difference in efficacy (95UCLD), control minus test, was required to be less than 10%.

Results

Ventricular Fibrillation

The efficacy of the 200J BTE shocks was demonstrated to be at least equivalent to the efficacy of 200J MDS shocks (95UCLD=2%). The difference in success rates of 200J MDS minus 200J BTE shocks was -10% (exact 95% confidence interval from -27% to 4%). The 130J BTE shocks were not demonstrated equivalent to 200J MDS shocks (95UCLD=22%). However, neither was their efficacy significantly lower than that of the 200J MDS shocks (statistical power limited by small sample sizes). For all shock types, hemodynamic parameters (oxygen saturation and systolic and diastolic blood pressure) were at or near their pre-induction levels by 30 seconds after successful shocks.

Shock	Ventricular Fibrillation 1st Shock Success	Exact 95% Confidence Interval
200J MDS	61/68 (90%)	80-96%
200J BTE	39/39 (100%)	91-100%
130J BTE	39/47 (83%)	69-92%

Ventricular Tachycardia

Seventy-two episodes of ventricular tachycardia (VT), induced in 62 patients, were treated with randomized shocks. High rates of conversion were observed with biphasic and monophasic shocks. Sample sizes were too small to statistically determine the relationship between success rates of the waveforms tested.

Shock	Ventricular Tachycardia 1st Shock Success	Exact 95% Confidence Interval
200J MDS	26/28 (93%)	77-99%
200J BTE	22/23 (96%)	78-100%
130J BTE	20/21 (95%)	76-100%

Conclusions

In this double-blinded study, the efficacy of the 200J BTE shocks was demonstrated to be at least equivalent to the efficacy of 200J MDS shocks for defibrillation of short duration, electrically-induced VF. However, the comparison of efficacy of 130J biphasic and 200J monophasic shocks for VF was

¹S.L. Higgins et al., "A comparison of biphasic and monophasic shocks for external defibrillation," *Prehospital Emergency Care*, 2000, 4(4):305-13.

inconclusive. All waveforms tested provided a high rate of termination of VT. The VT sample sizes were too small to statistically determine the relationship between VT success rates of the waveforms tested.

Compared to conventional shocks for VF, we found no positive or negative effect of biphasic shocks for VF on hemodynamic parameters following the defibrillating shock. It is possible that, compared to 200J monophasic shocks, 200J biphasic shocks will in some cases enable earlier termination of VF. Therefore, we conclude that biphasic shocks for VF delivered at conventional energy levels have the potential to improve outcome in resuscitation of patients with cardiac arrest.

CLINICAL SUMMARY: EXTERNAL CARIOVERSION OF ATRIAL FIBRILLATION

Overview

The performance of the Physio-Control biphasic truncated exponential (BTE) waveform was compared to the conventional monophasic damped sine (MDS) waveform in an international, multi-centered, prospective, randomized clinical study of adult patients undergoing elective cardioversion of atrial fibrillation (AF). A total of 80 patients were enrolled in the study and were treated with one or more study shocks. The primary dataset consisted of 72 enrolled patients confirmed to have been in AF. Data from seven patients with atrial flutter were analyzed separately. One patient who did not satisfy all protocol criteria was excluded from analysis.

Subjects were randomized to receive biphasic or monophasic shocks from LIFEPAK 12 defibrillator/monitors. Progressive shocks of 70, 100, 200 and 360 J of the assigned waveform, and a 360 J crossover shock of the other waveform, were delivered if AF persisted. Shocks were delivered using EDGE System QUIK-COMBO® Pacing/Defibrillation/ECG electrodes applied in the standard anterior-lateral position. Successful cardioversion was defined as the confirmed removal of AF after delivery of a shock, as determined by ECG over-read by two cardiologists with no knowledge of the shock waveform. Patients rated skin pain on a scale from 0 to 8 after the procedure.

This study showed that these biphasic shocks provide higher efficacy for cardioversion of atrial fibrillation, requiring fewer shocks, 65% less current and 65% less energy to cardiovert atrial fibrillation. Patients undergoing elective cardioversion with the biphasic protocol, as compared to those receiving the monophasic protocol, reported significantly less post-procedure pain.

Objectives

The primary objective of the study was to compare the cumulative efficacy of biphasic and monophasic shocks of 200 J or less for cardioversion of atrial fibrillation. A triangular sequential design was used to test for a statistically significant difference between groups of patients treated with these two waveforms.

Secondary objectives included 1) providing an estimation of the dose response relationship for the two waveforms which would allow clinicians to make well-informed selections of energy doses for cardioversion with biphasic shocks and 2) comparing the pain experienced by patients following treatment with monophasic and biphasic shocks.

Results

Seventy-two of the patients enrolled were in atrial fibrillation and 7 were in atrial flutter. On average, patients had been in atrial fibrillation for 88 days, were 66 years old, weighed 81 kg and had 72 ohms of transthoracic impedance. Sixty-three percent were male and 46% had been previously cardioverted. There were no significant differences between the groups of patients treated with monophasic and biphasic shocks, either in these baseline characteristics or in left atrial dimension, cardiac medications or diagnosis.

The cumulative success rates for cardioversion of atrial fibrillation are presented in Table A-5 and Figure A-1. These data provide a reasonable estimate of the expected probability of cardioversion success for a single shock at any given energy level within the range studied. Energy and peak current delivered for all shocks at each energy setting are presented in Table A-6.

Table A-5 Cumulative Success Rates and Crossover Results for Cardioversion of AF

Energy Setting	70 J	100 J	200 J	360 J	360 J Crossover Successes
MDS: n = 37	5.4%	19%	38%	86%	4 of 5 pts succeeded with 360 J BTE shock
BTE: n = 35	60%	80%	97%	97%	0 of 1 pts succeeded with 360 J MDS shock

Cumulative percentages of successes for cardioversion of AF with shocks of 200 J or less, the primary endpoint of the study, was significantly higher in the biphasic group than the monophasic group ($p < 0.0001$). The observed cumulative percentage of successes at 360 J was also higher for biphasic shocks than for monophasic shocks, but did not attain statistical significance.

Table A-6 Energy Settings, Delivered Energy and Peak Current for Shocks Delivered to Patients in AF

Energy Setting	Number of Patients	Delivered Energy	Peak Current, Amps
Monophasic shocks			
70 J	37	73 ±3	21.0 ±3.5
100 J	35	105 ±4	24.6 ±4.3
200 J	30	209 ±7	34.6 ±5.9
360 J	23	376 ±13	46.8 ±8
360 J crossover shocks	1	380	44.7
Biphasic shocks*			
70 J	35	71 ±0	11.9 ±2.5
100 J	14	102 ±0	14.9 ±3.5
200 J	7	203 ±1	20.6 ±3.5
360 J	1	362	28.5
360 J crossover shocks	5	361 ±6	32.4 ±8.5

*Peak current and delivered energy are not available for two of the patients treated with biphasic shocks.

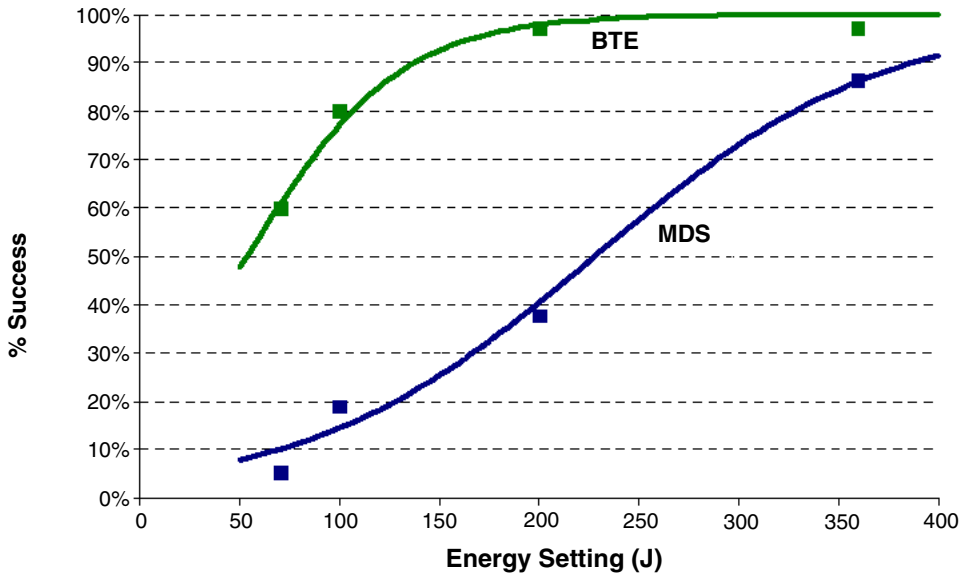

Figure A-1 Cumulative Shock Success for Cardioversion of Atrial Fibrillation with Monophasic (MDS) and Biphasic (BTE) Shocks: Observed Rates (n) Plotted with Estimated Dose Response Curves

Compared to monophasic shocks, biphasic shocks cardioverted atrial fibrillation with less peak current (14.0 ± 4.3 vs. 39.5 ± 11.2 A, $p < 0.0001$), less energy (97 ± 47 vs. 278 ± 120 J, $p < 0.0001$), fewer shocks (1.7 vs. 3.5 shocks, $p < 0.0001$) and less cumulative energy (146 ± 116 vs. 546 ± 265 J, $p < 0.0001$). Patients treated with the biphasic protocol, as compared to those treated with the monophasic protocol, reported significantly less post-procedure pain just after (0.4 ± 0.9 vs. 2.5 ± 2.2 , $p < 0.0001$) and 24 hours after the procedure (0.2 ± 0.4 vs. 1.6 ± 2.0 , $p < 0.0001$).

All patients with atrial flutter were cardioverted with the first shock (70 J), whether that shock was monophasic (n=4) or biphasic (n=3).

Anterior-lateral electrode placement was used for treatment of most (96%) of the patients studied. Reports in the literature differ on whether anterior-posterior electrode placement provides better shock efficacy than anterior-lateral placement. If there is a benefit to anterior-posterior electrode placement, it may be possible to obtain modestly higher cardioversion success rates with both waveforms than those observed in this study. However, placement is not likely to affect the observed relationship *between* the efficacies of monophasic and biphasic waveforms.

Conclusions

The data demonstrate the Physio-Control biphasic waveform is clinically superior to the conventional monophasic damped sine waveform for cardioversion of atrial fibrillation. Specifically, compared to monophasic shocks, biphasic shocks cardioverted atrial fibrillation with less peak current, less energy, fewer shocks and less cumulative energy. Patients undergoing elective cardioversion with the biphasic protocol, as compared to those receiving the monophasic protocol, reported significantly less post-procedure pain just after and 24 hours after the procedure. This may be due to fewer required shocks, less cumulative energy, less delivered peak current or other characteristics of this biphasic waveform.

Guidance for Selection of Shock Energy

Biphasic waveform technology is a standard in cardiac defibrillators. The study summarized here¹ provides the best information available on which to base energy selections for cardioversion with this waveform.

For cardioversion of atrial fibrillation, the results of this study provide specific guidance for three possible strategies in selection of shock energy levels.

- To optimize for more rapid cardioversion and fewer shocks, select the same biphasic energy levels used previously with monophasic defibrillators (for example, use 200 J biphasic instead of 200 J monophasic). This can be expected to increase the success rate yet decrease the peak current of the first and subsequent shocks.
- To maintain shock efficacy equivalent to that previously observed with monophasic shocks, select a biphasic energy level of about one-third the energy previously used for monophasic shocks (for example, use 100 J biphasic instead of 300 J monophasic).
- To optimize for low initial and cumulative energy using a step-up protocol, select 70 J for the first shock and use small increases in energy if further shocks are needed.

Each of these strategies should provide effective cardioversion therapy while substantially reducing the amount of peak current to which the heart is exposed.

For cardioversion of atrial arrhythmias other than atrial fibrillation, the data available to guide the selection of energy settings is very limited. It is likely that biphasic doses below 50 J will provide high success rates when treating atrial flutter and paroxysmal supraventricular tachycardia. However, until more clinical data becomes available, it may be advisable to use the same energy settings for biphasic shocks as are customarily used for monophasic shocks.

Arrhythmias may persist for a variety of reasons unrelated to the type of waveform used for cardioversion. In persistent cases, clinicians continue to have the option to either increase shock intensity or switch to an alternate electrode placement.

CLINICAL SUMMARY: INTRA-OPERATIVE VENTRICULAR DEFIBRILLATION

Overview

The defibrillation efficacy of the Physio-Control biphasic truncated exponential (BTE) waveform was compared to the standard monophasic damped sine waveform (MDS) in a prospective, randomized multi-center study of patients undergoing intra-operative, direct defibrillation for ventricular fibrillation (VF). A total of 251 adult patients were enrolled in the study; 98 of these developed VF that was treated with one or more study shocks. Seven patients who did not satisfy all protocol criteria were excluded from analysis.

Subjects were randomized to receive BTE or MDS shocks from LIFEPAK 12 defibrillator/monitors. Those who developed VF after removal of the aortic clamp received progressively stronger shocks of 2, 5, 7, 10 and 20 joules (J) using 2-inch paddles until defibrillation occurred. A 20 J crossover shock of the alternate waveform was given if VF persisted.

This study showed that these biphasic shocks have higher defibrillation efficacy, requiring fewer shocks, less threshold energy and less cumulative energy than monophasic damped sine shocks.

Objectives

The primary objective of the study was to compare the cumulative efficacy of BTE shocks to MDS shocks at 5 J or less. A triangular sequential design was used to test for a difference between waveform groups.

The secondary objective was to provide an estimation of the dose response relationship for the two waveforms that would allow physicians to make well-informed selections of energy doses for intra-operative defibrillation with biphasic shocks.

¹ Koster R, Dorian P., et al. A randomized trial comparing monophasic and biphasic waveform shocks for external cardioversion of atrial fibrillation. *American Heart Journal*, 2004;147(5):K1-K7.

Results

Thirty-five male and 15 female subjects were randomized to the BTE group; 34 and 7 to the MDS group. Mean age was 66 and 68 years, respectively. There were no significant differences between BTE and MDS treatment groups for cardiac etiology, arrhythmia history, current cardiac medications, American Society of Anesthesiology (ASA) risk class, left ventricular wall thickness, cardiopulmonary bypass time, core temperature or blood chemistry values at the time of aortic clamp removal.

Cumulative defibrillation success at 5 J or less, the primary endpoint of the study, was significantly higher in the BTE group than in the MDS group (p=0.011). Two of the 91 patients included in this primary endpoint analysis could not be included in more comprehensive analyses due to protocol variances that occurred in the shock sequence after the 5 J shock. Thus, the cumulative success rates for intra-operative defibrillation in the remaining 89 patients are presented in Table A-7 and Figure A-2. These data provide a reasonable estimate of the expected probability of defibrillation success for a single shock at any given energy level within the range studied.

Compared to the MDS group, the BTE group required, on average, fewer shocks (2.5 vs. 3.5: p=0.002), less threshold energy (6.8 J vs. 11.0 J: p=0.003) and less cumulative energy (12.6 J vs. 23.4 J: p=0.002). There was no significant difference between success rates for BTE versus MDS crossover shocks.

Table A-7 Cumulative Shock Success Rates and Crossover Shock Results for Intra-operative Defibrillation

Energy Setting	2 J	5 J	7 J	10 J	20 J	20 J Crossover Successes
MDS: n = 41	7%	22%	34%	51%	76%	3 of 8 pts succeeded with 20 J BTE shock
BTE: n = 48*	17%	52%	67%	75%	83%	3 of 8 pts succeeded with 20 J MDS shock

*Two subjects randomized to the BTE group were unable to be included in the cumulative success rates shown in the table and figure due to protocol deviations occurring after the 5 J shock.

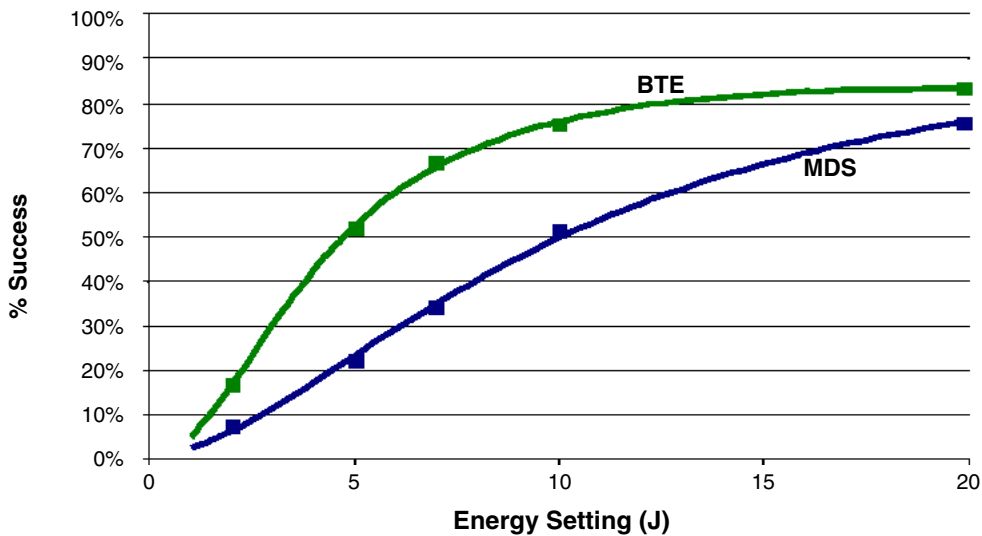

Figure A-2 Cumulative Shock Success for Intra-operative Defibrillation with Monophasic (MDS) and Biphasic (BTE) Shocks: Observed Rates (n) Plotted with Estimated Dose Response Curves

Conclusions

The data demonstrate that the Physio-Control biphasic waveform is clinically superior to the conventional monophasic damped sine waveform for intra-operative internal defibrillation of VF. Specifically, these biphasic shocks have higher defibrillation efficacy, while requiring fewer shocks, less threshold energy and less cumulative energy than monophasic damped sine shocks. There were no unsafe outcomes or adverse effects from the use of the biphasic waveform.

Guidance for Selection of Shock Energy

Biphasic waveform technology is a standard in cardiac defibrillators. The results of this study¹ provide specific guidance for three possible strategies in developing a dosing regimen.

- To optimize for lower initial and cumulative energy using a step-up protocol, select 5 J for the first shock and use small incremental increases in energy if further shocks are needed. In this study, biphasic shocks of 5 J were successful in approximately half of the patients.
- To optimize for more rapid defibrillation and fewer shocks, select the same BTE energy level used previously with MDS (for example, 20 J BTE instead of 20 J MDS), which can be expected to increase the success rate yet decrease by approximately 30% the peak current of the first and subsequent shocks.
- To maintain an equivalent degree of efficacy as previously observed with MDS shocks, a BTE energy level one-half of that previously used for MDS shocks (for example, 10 J BTE instead of 20 J MDS) would be an appropriate choice.

Each of these strategies should provide effective defibrillation therapy while substantially reducing the amount of peak current to which the heart is exposed.

Fibrillation may persist for a variety of reasons unrelated to the type of waveform used for defibrillation. In cases where fibrillation is persistent, physicians continue to have the option to either increase shock intensity or switch to a larger paddle size. Larger paddle size is known to decrease energy requirements for successful defibrillation.²

¹B. Schwarz et al., Biphasic shocks compared with monophasic damped sine wave shocks for direct ventricular defibrillation during open heart surgery. *Anesthesiology*. 2003;98(5):1063-1069.

²Y. Zhang et al., "Open chest defibrillation: biphasic versus monophasic waveform shocks," *J Am Coll Cardiol*, 2001, 37(2 supplement A):320A.

APPENDIX B SCREEN MESSAGES

Table B-1 lists and describes screen messages that the LIFEPAK 12 defibrillator/monitor may display during operation.

Table B-1 Summary of Screen Messages

Message	Description
ABNORMAL ENERGY DELIVERY (biphasic configuration)	Message appears if discharge occurs when the paddles are shorted together (see warning, page 4-13), if open air discharge occurs, or if the patient impedance is out of range. Message may also appear in certain types of internal faults.
ACCESS DENIED	Message appears after 3 consecutive incorrect attempts to enter the passcode for manual mode.
ACQUIRING 12-LEAD	Monitor is acquiring the data for 12-Lead ECG report.
ADVISORY MODE-MONITORING	Mode in which the unit is monitoring the patient ECG for a shockable rhythm and functioning as a semi-automatic external defibrillator.
ALARM APNEA	No valid breath has been detected for 30 seconds.
ALARMS SILENCED	Message appears whenever alarms are silenced. An alert tone with status message ALARMS SILENCED occurs periodically to remind you that alarms have been silenced.
ANALYZING 12-LEAD	Monitor is analyzing the data for 12-lead ECG report.
ANALYZING NOW-STAND CLEAR	The AED is analyzing the patient ECG rhythm.
BATTERY X LOW	Advises you when there is a low battery condition in one of the two installed batteries.
BUSY/WAITING TO REDIAL 202*	Destination may be busy receiving report from another device.
CALL NOT COMPLETED 200*	Unidentifiable connection error.
CALL NOT COMPLETED 203*	Call not answered.
CANNOT CHARGE	Message appears when CHARGE button is pressed and the synchronize source is missing for synchronized cardioversion, the therapy cable is not connected, or QUIK-COMBO electrodes are not attached to the therapy cable.
CHARGING TO XXX J	This message appears when you press the front panel or the standard paddles CHARGE button.
CHECK BATTERY	Message appears if communication with a FASTPAK 2 battery is lost.
CHECK CO2	CO2 module needs to be inspected by service personnel.
CHECK FOR PULSE	AED prompt after each standard 3 shock sequence or NO SHOCK ADVISED message.
CHECK PATIENT!	This message appears if a potentially shockable rhythm appears when in CPSS or if the VF/VT alarm is on.
CHECK PRINTER	Message appears when either the printer door is open, there is no paper in the printer, or there is any other printer malfunction.
CO2 AUTOZERO	Automatically performs a zero-point calibration.
CO2 FILTERLINE BLOCKAGE	EtCO2 filterline is twisted or clogged or airway adapter is clogged; the message appears after 30 seconds of unsuccessful purging.

Screen Messages

Message	Description
CO2 FILTERLINE OFF	EtCO2 FilterLine is disconnected.
CO2 FILTERLINE PURGING	EtCO2 filterline tube is twisted or clogged with liquid.
CO2 INITIALIZING	EtCO2 monitor is performing a self-check.
CONNECT CABLE	Message appears in Manual Mode if therapy cable is not connected when you press charge. Message appears in pacing mode if QUIK-COMBO cable is not connected when you increase current. Message appears in AED Advisory Mode if QUIK-COMBO cable is not connected when you press ANALYZE.
CONNECT CHEST LEADS	Message appears if the limb lead attachment is connected when 12-lead analysis is selected or active until you connect Leads V1-V6 or select another function.
CONNECT ELECTRODES	The defibrillator has detected that the therapy electrodes are disconnected.
CONNECTING	Message appears when transferring data using a direct connection between the defibrillator and a PC or other data processing equipment.
CURRENT FAULT	This message appears when the comparison between delivered and selected pacing current is out of tolerance.
DATA ERROR	Report contains a data error (cannot be transmitted).
DEMAND	Message appears when the pacemaker is in the Demand Mode.
DIALING	Monitor is waiting for dial tone or dialing the phone number.
DISARMING...	The disarming screen appears when the decision is made to dump the energy charge.
ECG CABLE OFF	Message appears when printing and the ECG cable is removed.
ECG LEADS OFF	Multiple ECG electrodes are disconnected either at power up or during monitoring.
ENERGY DELIVERED	Message appears following energy transfer.
ENERGY FAULT	Message appears when the comparison between stored and selected energy is out of tolerance. This message may display during defibrillation in Manual Mode or Advisory Mode.
ENERGY SELECT/XXX J	Message appears when you press the Front Panel or standard paddles ENERGY SELECT button.
EXCESSIVE NOISE 12-LEAD CANCELED	This message appears if the defibrillator detects noise for longer than 30 seconds that is too great to record a 12-Lead ECG report.
IF NO PULSE, PUSH ANALYZE	Message appears following CPR interval if so configured.
IF NO PULSE, START CPR	Prompts you to initiate CPR if no pulse and to continue with CPR until completion tone.
IF YOU WITNESSED THE ARREST, PUSH ANALYZE	INITIAL CPR message following START CPR prompt to remind user to deliver a shock immediately if the user witnessed the arrest.
LA LEADS OFF	ECG electrode LA disconnected.
LL LEADS OFF	ECG electrode LL is disconnected.

Message	Description
LOST CONNECTION 401*	Connection with the destination was interrupted.
MAINTENANCE DUE	Reminder message appears at the interval set in service mode. It will continue to appear until reset or turned off.
MANUAL MODE DISABLED	Message appears in the status region when Manual Mode is configured with Restricted Access.
MODEM INITIALIZATION ERROR 100*	Unidentifiable modem initialization error.
MODEM INITIALIZATION ERROR 102*	Modem initialization string is incorrect.
MODEM INITIALIZATION ERROR 103*	Fax modem setup error.
MODEM INITIALIZATION ERROR 104*	Fax modem failed to detect Class 2/2.0 fax host.
MOTION DETECTED!/STOP MOTION!	The defibrillator detects motion during ECG analysis, thereby inhibiting analysis.
NIBP AIR LEAK	NIBP cuff applied too loosely or there is a leak in cuff/monitor pneumatic system.
NIBP CHECK CUFF	NIBP cuff is not connected to patient or device.
NIBP FAILED	The NIBP monitor cannot establish zero-pressure reference.
NIBP FLOW ERROR	The NIBP pneumatic system is not maintaining stable cuff pressure.
NIBP INITIALIZING	Message appears when a NIBP is requested and unable to be successful due to a 30 second reset.
NIBP MOTION	The patient extremity moved too much for the NIBP monitor to accurately complete the measurement.
NIBP OVERPRESSURE	NIBP cuff pressure exceeded 290 mmHg.
NIBP RANGE ERROR	The NIBP systolic reading exceeds the measurement range of 255 mmHg.
NIBP TIME OUT	The NIBP monitor did not complete a measurement in 120 seconds.
NIBP WEAK PULSE	The monitor did not detect any pulses.
NO DIAL TONE 201*	No phone power. Disconnected cable or phone service not active.
NO ANSWER 203*	Call not answered.
NO MODEM FOUND 101*	Modem disconnected or modem is not connected to an analog telephone line.
NO PHONE NUMBER	Appears if a site or phone number has not been configured in Setup whenever a transmission is attempted.
NO SHOCK ADVISED	The defibrillator did not detect a shockable rhythm.
NOISY DATA! PRESS 12-LEAD TO ACCEPT	Monitor detects excessive signal interference, such as patient motion, while acquiring data. Message remains displayed while the monitor attempts to acquire data without interference. You may press the 12-LEAD button to override noisy data.

Screen Messages

Message	Description
NON-DEMAND	Message appears when the pacemaker is in Non-demand (asynchronous) Mode.
PX NOT ZEROED	Message appears when the transducer is connected or reconnected.
PX TRANSDUCER NOT DETECTED	Message appears when an IP transducer is disconnected from the defibrillator/monitor.
PX ZEROED	Message appears after successful zeroing of the transducer.
PX ZEROING	Message appears when zero is selected.
PACER FAULT	Pacemaker has detected a pacing fault condition due to high pacing rate or loss of interprocessor communication. Pacing function stops.
PACING STOPPED	Message appears and pacing stops whenever any of the following occurs: pacer electrodes off, pacer cable disconnected, or pacer failure due to high pacing rate or high impedance.
PASSCODE FAILED	Message appears in status region when an incorrect passcode has been entered.
PAUSED	Message appears when/while the pacing PAUSE button is pressed and held. Current pulses are applied at reduced frequency while the MA and PPM settings are maintained.
PUSH ANALYZE	Press ANALYZE to begin ECG analysis.
PUSH SELECTOR KNOB TO DISARM	Message appears on the charging screen overlays to instruct you how to disarm the charge.
PUSH PADDLE BUTTON TO SHOCK!	If internal paddles are attached, the front panel SHOCK button is disabled. Message appears if you attempt to transfer energy by pressing the front panel SHOCK button.
PUSH PADDLE BUTTONS TO SHOCK!	If standard paddles are attached, the front panel SHOCK button is disabled. Message appears if you attempt to transfer energy by pressing the front panel SHOCK button.
PUSH SHOCK BUTTON!	The defibrillator is fully charged and ready to provide therapy. This prompt appears when a therapy cable or internal paddles are connected.
RA LEADS OFF	ECG electrode RA is disconnected.
REPLACE BATTERY	Message appears when power loss is imminent due to a low battery condition.
SHOCK ADVISED!	The defibrillator has analyzed the patient ECG rhythm and detected a shockable ECG rhythm.
SPO2: CHECK SENSOR	The SpO2 sensor detached from the patient after a measurement was obtained.
SPO2: LOW PERFUSION	Patient has a weak pulse.
SPO2: NO SENSOR DETECTED	Indicates a sensor has disconnected from the monitor.
SPO2: SEARCHING FOR PULSE	Displays after the pulse oximetry sensor is first connected to the defibrillator.

Message	Description
SPO2: SENSOR OFF (Nellcor only)	This message appears if the SpO2 sensor comes off the patient for any reason once a measurement has been obtained.
SPO2: UNKNOWN SENSOR	A sensor is connected to a device that is not a Physio-Control approved sensor.
STAND CLEAR/PUSH SHOCK BUTTON	Prompts you to stand clear and push SHOCK button.
START CPR	The AED prompt that follows a NO SHOCK ADVISED decision or after a shock is delivered.
SWITCHING PRIMARY TO LEAD II	This message appears when PADDLES LEAD is not available and you have pressed the ADVISORY button.
SWITCHING PRIMARY TO PADDLES	This message appears when PADDLES LEAD is available and you have pressed the ADVISORY or ANALYZE button.
TRANSDUCER NOT DETECTED	Message appears when an IP transducer is disconnected from the defibrillator/monitor.
TRANSMISSION CANCELLED	LIFEPAK 12 operator cancelled the transmission.
TRANSMISSION COMPLETED	Defibrillator successfully transmits.
TRANSMISSION FAILED 500*	Defibrillator or phone battery low or power at destination is not on.
TRANSMISSION FAILED 501*	Wrong phone number or computer application program is not ready.
TRANSMISSION FAILED 502*	Fax host error during Phase-C, fine, ECM-on, 9600 bps negotiations.
TRANSMISSION FAILED 503*	Trying to send fax of the wrong type or fax is not available to transmit.
TRANSMISSION FAILED 600*	Connection is busy, defibrillator has tried to send data three times, or noisy phone connection or poor cellular service.
TRANSMISSION FAILED 601*	Destination device power not connected, wrong phone number, or receiving phone line not active.
UNABLE TO CONNECT 300*	Unidentifiable connection error.
UNABLE TO CONNECT 301*	Receiving site answered but unable to connect.
UNABLE TO CONNECT 302*	Receiving site answered but unable to connect within a timeout interval.
UNABLE TO CONNECT 303*	Fax host error at receiving end during Phase-A call establishment.
UNABLE TO CONNECT 304*	Fax host error at receiving end during Phase-B negotiations.

Screen Messages

Message	Description
USE ECG LEADS	Message appears when attempting synchronized cardioversion and PADDLES LEAD is selected.
USER TEST FAILED	Message appears following an unsuccessful User Test.
USER TEST IN PROGRESS	Message appears in the status region after you select the USER TEST Button from the OPTIONS overlay.
USER TEST PASSED	Message appears following a successful User Test.
VX LEADS OFF	ECG electrode "VX" (such as "V1") is disconnected.
XX LEADS OFF	ECG electrode "XX" (such as "RA") is disconnected.
XX% TRANSMITTED	xx% of the transmission is completed.
ZERO FAILED	Message appears when zeroing an IP transducer was attempted and was unsuccessful.

* Code numbers are printed in the event log and are not displayed on the screen. Refer to Table 6-5 for more information.

APPENDIX C OPERATOR'S CHECKLIST

This Operator's Checklist may be reproduced.

LIFEPAK® 12 Defibrillator/Monitor OPERATOR'S CHECKLIST



This is a recommended checklist to inspect and test this defibrillator. Inspection and testing of this defibrillator on a daily basis is recommended. This form may be reproduced.

Unit Serial No.: _____ Location: _____

Instruction	Recommended Corrective Action	Date							
		Initials							

Insert a ✓ in the box after completing each instruction.

1 Inspect physical condition for:

Foreign substances	Clean the device.	<input type="checkbox"/>	<input type="checkbox"/>	<input type="checkbox"/>	<input type="checkbox"/>	<input type="checkbox"/>	<input type="checkbox"/>	<input type="checkbox"/>	<input type="checkbox"/>
Damage or cracks	Contact a qualified service technician.	<input type="checkbox"/>	<input type="checkbox"/>	<input type="checkbox"/>	<input type="checkbox"/>	<input type="checkbox"/>	<input type="checkbox"/>	<input type="checkbox"/>	<input type="checkbox"/>

2 Inspect batteries for:

Broken, loose, or worn battery pins	Contact a qualified service technician.	<input type="checkbox"/>	<input type="checkbox"/>	<input type="checkbox"/>	<input type="checkbox"/>	<input type="checkbox"/>	<input type="checkbox"/>	<input type="checkbox"/>	<input type="checkbox"/>
Damaged or leaking battery	Discard/recycle battery.	<input type="checkbox"/>	<input type="checkbox"/>	<input type="checkbox"/>	<input type="checkbox"/>	<input type="checkbox"/>	<input type="checkbox"/>	<input type="checkbox"/>	<input type="checkbox"/>

3 Inspect ECG cable for:

Cracking, damage, broken or bent parts or pins	Replace ECG cable.	<input type="checkbox"/>	<input type="checkbox"/>	<input type="checkbox"/>	<input type="checkbox"/>	<input type="checkbox"/>	<input type="checkbox"/>	<input type="checkbox"/>	<input type="checkbox"/>
------------------------------------------------	--------------------	--------------------------	--------------------------	--------------------------	--------------------------	--------------------------	--------------------------	--------------------------	--------------------------

4 Check ECG and therapy electrodes for:

Expiration date	Replace if expired.	<input type="checkbox"/>	<input type="checkbox"/>	<input type="checkbox"/>	<input type="checkbox"/>	<input type="checkbox"/>	<input type="checkbox"/>	<input type="checkbox"/>	<input type="checkbox"/>
Spare electrodes available	Obtain spare electrodes.	<input type="checkbox"/>	<input type="checkbox"/>	<input type="checkbox"/>	<input type="checkbox"/>	<input type="checkbox"/>	<input type="checkbox"/>	<input type="checkbox"/>	<input type="checkbox"/>

5 With the battery installed, disconnect the device from AC power adapter, if applicable, and wait at least 2 seconds*. Then press ON and look for:

Momentary illumination of Self-test messages and LEDs	If absent, contact a qualified service technician.	<input type="checkbox"/>	<input type="checkbox"/>	<input type="checkbox"/>	<input type="checkbox"/>	<input type="checkbox"/>	<input type="checkbox"/>	<input type="checkbox"/>	<input type="checkbox"/>
LOW BATTERY or REPLACE BATTERY message	Replace the battery immediately.	<input type="checkbox"/>	<input type="checkbox"/>	<input type="checkbox"/>	<input type="checkbox"/>	<input type="checkbox"/>	<input type="checkbox"/>	<input type="checkbox"/>	<input type="checkbox"/>
Two fully charged batteries	Replace low battery.	<input type="checkbox"/>	<input type="checkbox"/>	<input type="checkbox"/>	<input type="checkbox"/>	<input type="checkbox"/>	<input type="checkbox"/>	<input type="checkbox"/>	<input type="checkbox"/>
Service indicator illuminated (on device or power adapter)	Contact a qualified service technician.	<input type="checkbox"/>	<input type="checkbox"/>	<input type="checkbox"/>	<input type="checkbox"/>	<input type="checkbox"/>	<input type="checkbox"/>	<input type="checkbox"/>	<input type="checkbox"/>

6 Perform therapy cable or standard hard paddles check in manual mode:

QUIK-COMBO therapy cable check (if this cable is not used with the defibrillator, go to Standard Paddles User Test)

a Examine cable for cracking, damage, broken or bent parts or pins.	Replace QUIK-COMBO therapy cable.	<input type="checkbox"/>	<input type="checkbox"/>	<input type="checkbox"/>	<input type="checkbox"/>	<input type="checkbox"/>	<input type="checkbox"/>	<input type="checkbox"/>	<input type="checkbox"/>
b Connect therapy cable to defibrillator and the Test Load.	If CONNECT ELECTRODES, PADDLES LEADS OFF, or CONNECT CABLE message appears, replace therapy cable and repeat check. If problem continues, remove the defibrillator from use and contact a qualified service technician.	<input type="checkbox"/>	<input type="checkbox"/>	<input type="checkbox"/>	<input type="checkbox"/>	<input type="checkbox"/>	<input type="checkbox"/>	<input type="checkbox"/>	<input type="checkbox"/>
c Select 200 joules and press CHARGE button.		<input type="checkbox"/>	<input type="checkbox"/>	<input type="checkbox"/>	<input type="checkbox"/>	<input type="checkbox"/>	<input type="checkbox"/>	<input type="checkbox"/>	<input type="checkbox"/>
d Press SHOCK button.		<input type="checkbox"/>	<input type="checkbox"/>	<input type="checkbox"/>	<input type="checkbox"/>	<input type="checkbox"/>	<input type="checkbox"/>	<input type="checkbox"/>	<input type="checkbox"/>
e Confirm ENERGY DELIVERED message appears.	If message does not appear, repeat as stated above.	<input type="checkbox"/>	<input type="checkbox"/>	<input type="checkbox"/>	<input type="checkbox"/>	<input type="checkbox"/>	<input type="checkbox"/>	<input type="checkbox"/>	<input type="checkbox"/>
f Remove the Test Load from cable.		<input type="checkbox"/>	<input type="checkbox"/>	<input type="checkbox"/>	<input type="checkbox"/>	<input type="checkbox"/>	<input type="checkbox"/>	<input type="checkbox"/>	<input type="checkbox"/>

* Always allow at least 2 seconds between turning on the device and disconnecting from AC power, regardless of the order of the actions.

APPENDIX D SHOCK ADVISORY SYSTEM

This appendix describes the basic function of the Shock Advisory System (SAS).

OVERVIEW OF THE SHOCK ADVISORY SYSTEM

The Shock Advisory System (SAS) is an ECG analysis system built into the biphasic LIFEPAK 12 defibrillator/monitor that advises the operator if it detects a shockable or nonshockable rhythm. This system makes it possible for individuals who are not trained to interpret ECG rhythms to provide potentially lifesaving therapy to victims of ventricular fibrillation or pulseless ventricular tachycardia.

The Shock Advisory System contains the following features:

- Electrode Contact Determination
- Automated Interpretation of the ECG
- Operator Control of Shock Therapy
- Continuous Patient Surveillance System (CPSS)
- Motion Detection

The Shock Advisory System is active when the biphasic LIFEPAK 12 defibrillator/monitor is used as an automated external defibrillator (AED).

Electrode Contact Determination

The Shock Advisory System measures the patient's transthoracic impedance through the therapy electrodes. If the baseline impedance is higher than a maximum limit, it determines that the electrodes do not have sufficient contact with the patient or are not properly connected to the AED. When this occurs, ECG analysis and shock delivery are inhibited. The AED advises the operator to connect electrodes when there is insufficient electrode contact.

Automated Interpretation of the ECG

The Shock Advisory System recommends a shock if it detects the following:

- Ventricular fibrillation — with a peak-to-peak amplitude of at least 0.08 mV.
- Ventricular tachycardia — defined as having a heart rate of at least 120 beats per minute, QRS width of at least 0.16 seconds, and no apparent P waves.

Pacemaker pulses may prevent advisement of an appropriate shock, regardless of the patient's underlying rhythm. The Shock Advisory System is designed to recommend no shock for all other ECG rhythms, including asystole, pulseless electrical activity, idioventricular rhythms, bradycardia, supraventricular tachycardias, and normal sinus rhythms.

ECG analysis is performed on consecutive 2.7-second segments of ECG. The analysis of two out of three consecutive segments must agree before a decision (SHOCK ADVISED or NO SHOCK ADVISED) is made.

SAS performance is summarized in the following table.

Table D-1 LIFEPAK 12 Defibrillator/Monitor SAS Performance

Rhythm Class	ECG Test ¹ Sample Size	Performance Goal	Observed Performance
Shockable: VF	168	>90% sensitivity	LIFEPAK 12 defibrillator/monitor meets the AAMI DF39 ² requirements and AHA recommendations ³ .
Shockable: VT	65	>75% sensitivity	LIFEPAK 12 defibrillator/monitor meets the AAMI DF39 requirements and AHA recommendations.
Nonshockable: NSR	144	>99% specificity for NSR (AHA)	LIFEPAK 12 defibrillator/monitor meets the AHA recommendations.
Nonshockable: asystole	43	>95% specificity	LIFEPAK 12 defibrillator/monitor meets the AAMI DF39 requirements and AHA recommendations.

Rhythm Class	ECG Test ¹ Sample Size	Performance Goal	Observed Performance
Nonshockable: all other rhythms	531	>95% specificity	LIFEPAK 12 defibrillator/monitor meets the AAMI DF39 requirements and AHA recommendations.
Intermediate: fine VF	29	Report only	89.7% sensitivity

¹From Physio-Control ECG database. Each sample is run 10 times asynchronously.

²Association for the Advancement of Medical Instrumentation. DF39-1993 Standard for Automatic External Defibrillators and Remote-Control Defibrillators. Arlington, VA: AAMI;1993.

³Automatic External Defibrillators for Public Access Defibrillation: Recommendations for Specifying and Reporting Arrhythmia Analysis Algorithm Performance, Incorporating New Waveforms, and Enhancing Safety. AHA Task Force on Automatic External Defibrillation, Subcommittee on AED Safety and Efficacy. *Circulation*, 1997, Vol. 95, 1677-1682.

VF = ventricular fibrillation

VT = ventricular tachycardia

NSR = normal sinus rhythm

Operator Control of Shock Therapy

The Shock Advisory System causes the AED to charge automatically when it detects the presence of a shockable rhythm. When a shock is advised, the operator presses the **SHOCK** button to deliver the energy to the patient.

Continuous Patient Surveillance System

The Continuous Patient Surveillance System (CPSS) automatically monitors the patient's ECG rhythm for a potentially shockable rhythm while the electrodes are attached and the AED is turned on. CPSS is not active during ECG analysis or when the AED is in a CPR cycle.

The Shock Advisory System does not detect motion while CPSS is active. Therefore, there is a chance that motion distortion in the ECG rhythm may be interpreted by CPSS as a potentially shockable rhythm.

Motion Detection

The Shock Advisory System detects patient motion independent of ECG analysis. A motion detector is designed into the LIFEPAK 12 defibrillator/monitor. **MOTION DETECTION** can be configured in the setup mode to be **ON** or **OFF**.

A number of activities can create motion, including CPR, rescuer movement, patient movement, and some internal pacemakers. If variations in the transthoracic impedance signal exceed a maximum limit, the Shock Advisory System determines that patient motion of some kind is present. If motion is detected, the ECG analysis is inhibited. The operator is advised by a displayed message, a voice prompt, and an audible alert. After 10 seconds, if motion is still present, the motion alert stops and the analysis always proceeds to completion. This limits the delay in therapy in situations where it may not be possible to stop the motion. However, the rescuer should remove the source of motion whenever possible to minimize the chance of artifact in the ECG.

There are two reasons why ECG analysis is inhibited when the motion alert occurs, and why the rescuer should remove the source of the motion whenever possible:

- Such motion may cause artifact in the ECG signal. This artifact may occasionally cause the Shock Advisory System to reach an incorrect decision.
- The motion may be caused by a rescuer's interventions. To reduce the risk of inadvertently shocking a rescuer, the motion alert prompts the rescuer to move away from the patient. This will stop the motion and ECG analysis will proceed.

The motion detection feature can be set to **OFF**. When this option is off, analysis of the ECG is allowed to proceed uninhibited even in the presence of motion, which may or may not cause artifact in the

ECG as described previously. Artifact in the ECG can sometimes cause an erroneous shock advisory decision.

The skill and training level of the care providers should be taken into consideration when deciding whether or not to turn off the motion detection feature. How readily do the users respond to the AED voice prompt? For example, do they immediately stop CPR upon hearing the *ANALYZING NOW, STAND CLEAR* prompt?

APPENDIX E INSERVICE MODE

This appendix describes the inservice mode.

INTRODUCTION

The inservice mode allows you to practice or demonstrate monitoring functions of the LIFEPAK 12 defibrillator/monitor without the device being connected to a patient or patient simulator. The following functions are active in inservice mode:

- ECG lead selection
- SpO2
- EtCO2
- NIBP
- IP
- Trend graphs
- Alarms
- Events

Accessing the Inservice Mode

To access the inservice mode:

- 1 Check that the defibrillator power is off and that all cables are disconnected.
- 2 While pressing the HOME and EVENT buttons, press the ON button. Continue to press all three buttons until the inservice screen appears:

Inservice Screen

Exit the inservice mode by turning off the defibrillator power.

Changing the ECG Lead

- 1 Rotate the SELECTOR to select Channel 1. The Channel 1 area at the top of the screen is highlighted.
- 2 Press the SELECTOR. The Channel 1 overlay appears.
- 3 Rotate the SELECTOR to Lead and press. The list of ECG Leads I, II, and III appears.
- 4 Rotate to Lead I, II or III, as desired, and press. The selected Lead appears on the display screen.

Selecting SpO2

- 1 Rotate the SELECTOR to highlight the SpO2 parameter at the left side of the screen.
- 2 Press the SELECTOR. The following overlay appears:

SPO2

You can change the SpO2 volume by pressing and rotating the SELECTOR.

Selecting SpO2, EtCO2, and Invasive Pressure Waveforms or Trend Graphs

- 1 Rotate the SELECTOR to select Channel 2 or Channel 3.
- 2 Press the SELECTOR.
The Channel overlay appears.
- 3 Press the SELECTOR.
The list of waveform options appears.
- 4 Rotate the SELECTOR to highlight the desired waveform and press.
- 5 Press HOME SCREEN. The waveform is now visible.

To change the waveform scale:

- 1 Rotate the SELECTOR to highlight the parameter area at the left side of the screen.
- 2 Press the SELECTOR.
- 3 Select scale by rotating and pressing the SELECTOR.

Note: The CO2 waveform changes amplitude every 20 breaths so you can change scales.

Selecting NIBP

- 1 Rotate the **SELECTOR** to highlight the NIBP parameter at the left side of the screen.
- 2 Press the **SELECTOR**.

You can change the amplitude intervals and the initial cuff pressure by rotating and pressing the **SELECTOR**.

Selecting IP

- 1 Rotate the **SELECTOR** to highlight the P1 or P2 parameter at the left side of the screen.
- 2 Press the **SELECTOR**.

You can label the pressure waveform, select a scale, and zero the transducer by rotating and pressing the **SELECTOR**.

Changing Alarm Settings

- 1 Press **ALARMS**. The Alarms overlay appears.
- 2 Rotate the **SELECTOR** to Quick Set and press. The Heart Rate display changes to show alarm limits.
- 3 Observe the Heart Rate display. After about 1 minute, the Heart Rate goes into alarm.
- 4 Press the **ALARMS** button. Alarms are silenced for 2 minutes.

Note: The Heart Rate alternates every 2 minutes between alarm and non-alarm states.

Selecting Patient Events

- 1 Press **EVENT**. The following overlay appears:
Event
- 2 Rotate the **SELECTOR** to highlight the desired event.
- 3 Press and rotate the **SELECTOR** to change an event.

Note: You cannot enter a self-created event.

APPENDIX F INTERNATIONAL TRANSMIT CONNECTIONS

This appendix describes the transmit connections for international customers only.

**EQUIPMENT CONNECTIONS FOR INTERNAL MODEM – CELLULAR
(INTERNATIONAL CUSTOMERS ONLY)**

Figure F-1 shows you the equipment connections for transmitting reports by global systems mobile (GSM) cellular telephone using an internal PC Card interface.

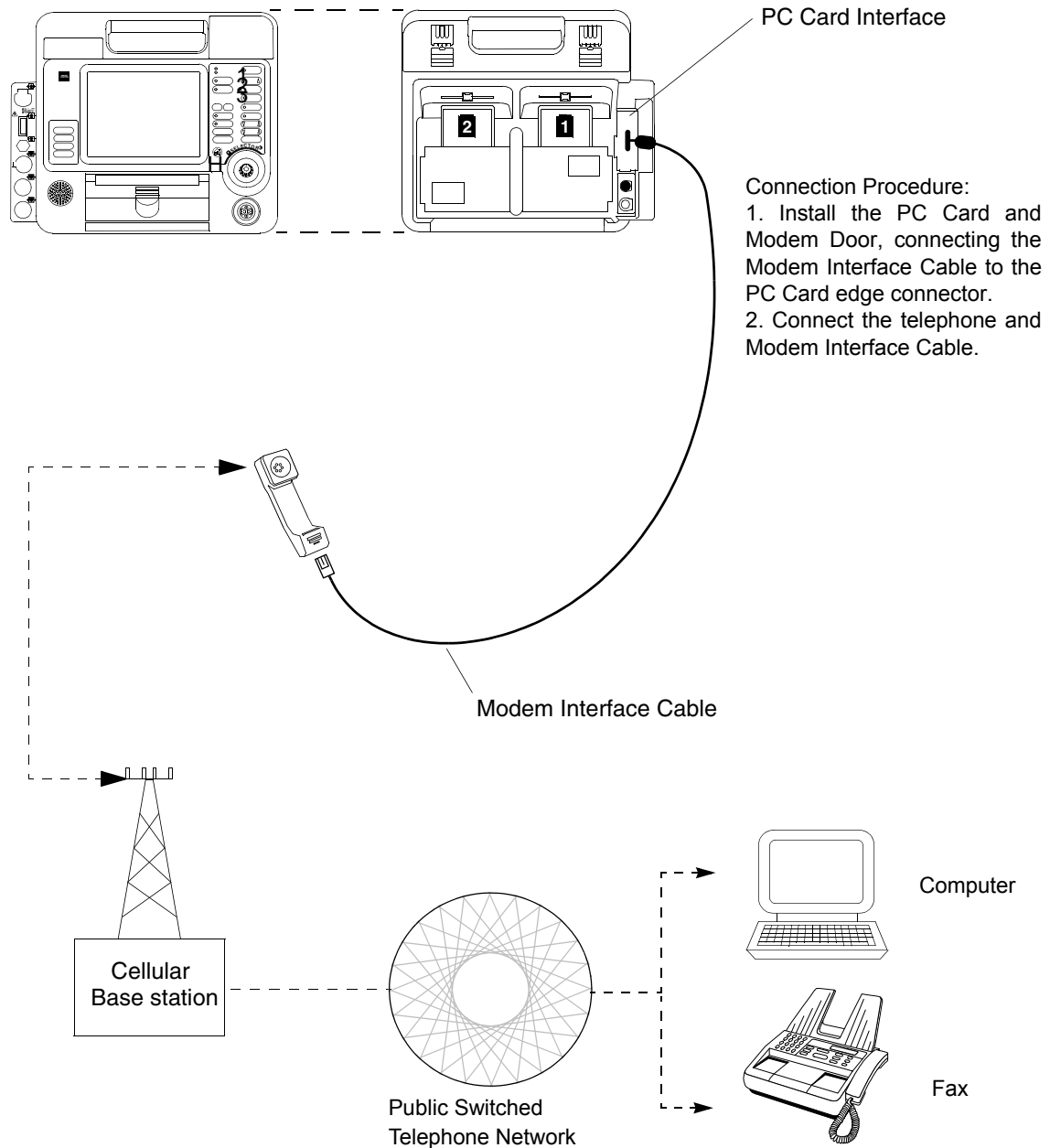

Appendixes

Figure F-1 Equipment Connections for Internal Modem – Cellular (International Customers Only)

APPENDIX G
ABOUT CPRMAX TECHNOLOGY

ABOUT CPRMAX TECHNOLOGY

Physio-Control cprMAX™ technology is designed to allow resuscitation protocols to maximize the quantity of CPR administered during treatment with an AED, consistent with the 2005 American Heart Association Guidelines for Cardiopulmonary Resuscitation and Emergency Cardiovascular Care ¹ (AHA Guidelines) and the European Resuscitation Council Guidelines for Resuscitation 2005 ².

Setup options should be changed only under the direction of a physician knowledgeable in cardiopulmonary resuscitation who is familiar with the literature in this area.

The cprMAX technology includes the following setup options:

- **INITIAL CPR.** Prompts the user to perform an initial period of CPR. Applies only to immediately after turning on the AED or after the first analysis.
- **PRESHOCK CPR TIME.** Prompts for CPR after a shockable ECG rhythm is detected, before the shock is delivered. If INITIAL CPR is set to OFF, then PRESHOCK CPR applies to all shock advised decisions (including the first analysis).
- **CPR TIME 1 AND 2.** CPR time periods after shocks or no shock advised decisions respectively.
- **STACKED SHOCKS.** Eliminates the analysis after each shock and inserts prompting for CPR after each shock. This eliminates the three-shock stack.
- **PULSE CHECK.** Indicates when, if ever, the device is to prompt for pulse checks.

AED protocols are aligned with the AHA and ERC Guidelines when the setup options are set as follows:

- Initial CPR: OFF
- PreShock CPR Time: OFF
- CPR Times 1 & 2: 120 SECONDS
- Stacked Shocks: OFF
- Pulse Check: NEVER

The above options are the factory default settings for cprMAX technology. Your hospital procedures should determine whether or not to change the options and should ensure that you receive training.

The adult ventricular fibrillation (VF) energy label is also provided as the recommended energy for treating VF. Refer to the label on your defibrillator for recommended doses.

AED OPERATION WITH CPRMAX TECHNOLOGY

The following paragraphs describe AED operation with cprMAX technology setup options.

Initial CPR

The INITIAL CPR option prompts the user to perform an initial period of CPR. The choices are: OFF, ANALYZE FIRST and CPR FIRST. The factory default is OFF.

- The OFF setting has no prompting for an initial CPR period.
- The ANALYZE FIRST setting prompts for analysis and then CPR. If the analysis determines that a shock is needed, the AED will prompt, *IF YOU WITNESSED THE ARREST, PUSH ANALYZE*, which provides the opportunity to end CPR early and proceed directly to delivering a shock.
- The CPR FIRST setting prompts the user to perform CPR immediately after the defibrillator is powered on. The AED will also prompt, *IF YOU WITNESSED THE ARREST, PUSH ANALYZE*, which provides the opportunity to end CPR early and proceed directly to analysis.

1.2005 American Heart Association Guidelines for Cardiopulmonary Resuscitation and Emergency Cardiovascular Care. Circulation 2005;112 (Supplement IV).

2.European Resuscitation Council Guidelines for Resuscitation 2005. J. Resuscitation 2005; 67 (Supplement 1).

Hospital protocols which choose to implement this option should develop a protocol and provide training to responders instructing them when to end the initial CPR interval early. Potential situations for instructing responders to end CPR early include:

- The patient's collapse was witnessed by the responder.
- The responder ascertains that fewer than four or five minutes have elapsed since the patient's collapse.
- The patient exhibits agonal breathing, an indicator of a short downtime.
- The responder ascertains that CPR of adequate quality and duration has already been provided before attaching the AED electrodes.

Refer to "Special AED Setup Options" on page 4-9 for a more detailed description of the AED prompting sequence for each INITIAL CPR option.

Initial CPR Time

The INITIAL CPR TIME option applies when INITIAL CPR is set to ANALYZE FIRST or CPR FIRST. It sets the CPR time for that CPR period. The time choices for INITIAL CPR TIME are: 15, 30, 45, 60, 90, 120, and 180 SECONDS. The default setting is 120 seconds.

Preshock CPR Time

The PRESHOCK CPR time option inserts prompting for CPR when a shockable ECG rhythm is detected and during the time the AED is charging. It applies only when analysis results in *SHOCK ADVISED* decisions. When INITIAL CPR is set to OFF or CPR FIRST, PRESHOCK CPR time applies to the first and all subsequent shocks. When INITIAL CPR is set to ANALYZE FIRST, PRESHOCK CPR time applies to the second and all subsequent shocks. The choices for PRESHOCK CPR time are: OFF, 15, and 30 SECONDS. To prompt for CPR only for the time the capacitor is charging, select the 15-seconds CPR interval. The SHOCK button is not enabled until charging and CPR time are completed. The default setting for PRESHOCK CPR time is OFF.

Note: Although the SHOCK button is disabled during the PRESHOCK CPR interval, it becomes active as soon as the PRESHOCK CPR interval ends. To minimize the interval between the final chest compression and shock delivery (while maintaining responder safety), hospital protocols which select this option should provide specific training and protocols to address the rapid transition from PRESHOCK CPR to shock delivery.

Stacked Shocks

When set to OFF, the STACKED SHOCKS option inserts prompting for CPR after each (a single) shock. This eliminates the three-shock stack. CPR is prompted after the shock regardless of the ECG rhythm. The CPR time following the shock is determined by the CPR TIME 1 setting selected. Choices for the STACKED SHOCKS option are ON or OFF. The default setting is OFF.

When this option is set to ON, the defibrillator follows the previously traditional stacked shock protocol and delivers up to three consecutive shocks, as necessary, without interposed CPR.

Pulse Check

The PULSE CHECK option inserts prompting to check for a pulse or check the patient, depending on the PULSE PROMPT setting. The choices for PULSE CHECKS are: ALWAYS, AFTER EVERY NSA, AFTER SECOND NSA, and NEVER. The default setting is NEVER.

- The ALWAYS option prompts for a pulse check after CPR Times 1 and 2, after a *NO SHOCK ADVISED* decision, after a single *SHOCK ADVISED* decision with STACKED SHOCKS OFF, or after three consecutive *SHOCK ADVISED* decisions IF STACKED SHOCKS is ON.
- The AFTER EVERY NSA option prompts for a pulse check after every *NO SHOCK ADVISED* decision.

- The *AFTER SECOND NSA* option prompts for a pulse check after the second analysis if the second analysis results in a *NO SHOCK ADVISED* decision, regardless of the first analysis decision (*SHOCK ADVISED* or *NO SHOCK ADVISED*).
- The *NEVER* option eliminates all *PULSE CHECK* prompts.

APPENDIX H

ELECTROMAGNETIC COMPATIBILITY GUIDANCE

Table H-1 Guidance and Manufacturer’s Declaration - Electromagnetic Emissions

<p>The LIFEPAK® 12 defibrillator/monitor system is intended for use in the electromagnetic environment specified below. The customer or the user of the LIFEPAK 12 defibrillator/monitor system should ensure that the device is used in such an environment.</p>		
Emissions Test	Compliance	Electromagnetic Environment - Guidance
RF emissions CISPR 11	Group 1	The LIFEPAK 12 defibrillator/monitor system uses RF energy only for its internal function. Therefore, its RF emissions are very low and are not likely to cause any interference in nearby electronic equipment.
RF emissions CISPR 11	Class B	The LIFEPAK 12 defibrillator/monitor system is suitable for use in all establishments, including domestic establishments and those directly connected to the public low-voltage power supply network that supplies buildings used for domestic purposes.
Harmonic emissions IEC 61000-3-2	Class A	
Voltage fluctuations/ flicker emissions IEC 61000-3-3	Complies	

Essential Performance

The LIFEPAK 12 defibrillator/monitor system maintains safe and effective performance of the defibrillation therapy and patient monitoring functions when operated in the electromagnetic environment specified in Tables 2 through 4.

Electromagnetic Compatibility Guidance

Table H-2 Guidance and Manufacturer's Declaration - Electromagnetic Immunity

The LIFEPAK 12 defibrillator/monitor system is intended for use in the electromagnetic environment specified below. The customer or the user of the LIFEPAK 12 defibrillator/monitor system should ensure that the device used in such an environment.			
Immunity Test	IEC 60601 Test Level	Compliance Level	Electromagnetic Environment - Guidance
Electrostatic discharge (ESD) IEC 61000-4-2	±6 kV contact ±8 kV air	±8 kV contact ±15 kV air	The LIFEPAK 12 defibrillator/monitor system is suitable for use in a dry environment.
Electrical fast transient/burst IEC 61000-4-4	±2 kV for power supply lines ±1 kV for input/output lines	±2 kV for power supply lines ±1 kV for input/output lines	Mains power quality should be that of a typical commercial or hospital environment.
Surge IEC 61000-4-5	±1 kV differential mode ±2 kV common mode	±1 kV differential mode ±2 kV common mode	Mains power quality should be that of a typical commercial or hospital environment.
Voltage dips, short interruptions and voltage variations on power supply input lines IEC 61000-4-11	<5% U_T (>95% dip in U_T) for 0.5 cycle 40% U_T (60% dip in U_T) for 5 cycles 70% U_T (30% dip in U_T) for 25 cycles <5% U_T (>95% dip in U_T) for 5 s	<5% U_T (>95% dip in U_T) for 0.5 cycle 40% U_T (60% dip in U_T) for 5 cycles 70% U_T (30% dip in U_T) for 25 cycles <5% U_T (>95% dip in U_T) for 5 s	Mains power quality should be that of a typical commercial or hospital environment. If the user of the LIFEPAK 12 defibrillator/monitor system requires continued operation during power mains interruptions, it is recommended that the device be powered from an uninterruptible power supply or a battery.
Power frequency (50/60 Hz) magnetic field IEC 61000-4-8	3 A/m	3 A/m	Power frequency magnetic fields should be at levels characteristic of a typical location in a typical commercial or hospital environment.
Note: U_T is the a.c. mains voltage prior to application of the test level.			

Table H-3 Guidance and Manufacturer’s Declaration - Electromagnetic Immunity

The LIFEPAK 12 defibrillator/monitor system is intended for use in the electromagnetic environment specified below. The customer or the user of the LIFEPAK 12 defibrillator/monitor system should ensure that the device is used in such an electromagnetic environment.			
Immunity Test	IEC 60601 Test Level	Compliance Level	Electromagnetic Environment - Guidance
Conducted RF IEC 61000-4-6	3 Vrms 150 kHz to 80 MHz outside ISM bands ^a	3 Vrms	Portable and mobile RF communications equipment should be used no closer to any part of the LIFEPAK 12 defibrillator/monitor system, including cables, than the recommended separation distance calculated from the equation applicable to the frequency of the transmitter. Recommended separation distance $d = 1.2\sqrt{P}$
	10 Vrms 150 kHz to 80 MHz in ISM bands ^a	10 Vrms	$d = 1.2\sqrt{P}$
Radiated RF IEC 61000-4-3	10 V/m 80 MHz to 2.5 GHz	10 V/m	$d = 1.2\sqrt{P}$ 80 MHz to 800 MHz $d = 2.3\sqrt{P}$ 800 MHz to 2.5 GHz Where P is the maximum output power rating of the transmitter in watts (w) according to the transmitter manufacturer and d is the recommended separation distance in meters (m). ^b Field strengths from fixed RF transmitters, as determined by an electromagnetic site survey, ^c should be less than the compliance level in each frequency range. ^d Interference may occur in the vicinity of equipment marked with the following symbol: 
<p>Note 1:At 80 MHz and 800 MHz, the higher frequency range applies.</p> <p>Note 2:These guidelines may not apply in all situations. Electromagnetic propagation is affected by absorption and reflection from structures, objects and people.</p>			

- a. The ISM (industrial, scientific and medical) bands between 150 kHz and 80 MHz are 6,765 MHz to 6,795 MHz; 13,553 MHz to 13,567 MHz; 26,957 MHz to 27,283 MHz; and 40,66 MHz to 40,70 MHz.
- b. The compliance levels in the ISM frequency bands between 150 kHz and 80 MHz and in the frequency range 80 MHz to 2.5 GHz are intended to decrease the likelihood that mobile/portable communications equipment could cause interference if it is inadvertently brought into patient areas. For this reason, an additional factor of 10/3 is used in calculating the recommended separation distance for transmitters in these frequency ranges.

Electromagnetic Compatibility Guidance

- c. Field strengths from fixed transmitters, such as base stations for radio (cellular/cordless) telephones and land mobile radios, amateur radio, AM and FM radio broadcast and TV broadcast cannot be predicted theoretically with accuracy. To assess the electromagnetic environment due to fixed RF transmitter, an electromagnetic site survey should be considered. If the measured field strength in the location in which the LIFEPAK 12 defibrillator/monitor system is used exceeds the applicable RF compliance level above, the LIFEPAK 12 defibrillator/monitor system should be observed to verify normal operation. If abnormal performance is observed, additional measures may be necessary, such as re-orienting or relocating the LIFEPAK 12 defibrillator/monitor system.
- d. Over the frequency range 150 kHz to 80 MHz, field strengths should be less than 3V/m.

Table H-4 Recommended Separation Distances between Portable and Mobile RF Communications Equipment and the LIFEPAK 12 defibrillator/monitor system

The LIFEPAK 12 defibrillator/monitor system is intended for use in an electromagnetic environment in which radiated RF disturbances are controlled. The customer or the user of the LIFEPAK 12 defibrillator/monitor system can help prevent electromagnetic interference by maintaining a minimum distance between portable and mobile RF communications equipment (transmitters) and the LIFEPAK 12 defibrillator/monitor system as recommended below, according to the maximum output power of the communications equipment.				
Rated maximum output power of transmitter W	Separation distance according to frequency of transmitter m			
	150 kHz to 80 MHz outside ISM bands $d = 1.2\sqrt{P}$	150 kHz to 80 MHz in ISM bands $d = 1.2\sqrt{P}$	80 MHz to 800 MHz $d = 1.2\sqrt{P}$	800 MHz to 2.5 GHz $d = 2.3\sqrt{P}$
0.01	0.12	0.12	0.12	0.23
0.1	0.38	0.38	0.38	0.73
1	1.2	1.2	1.2	2.3
10	3.8	3.8	3.8	7.3
100	12	12	12	23

For transmitters rated at a maximum output power not listed above, the recommended separation distance d in meters (m) can be determined using the equation applicable to the frequency of the transmitter, where P is the maximum output power rating of the transmitter in watts (W) according to the transmitter manufacturer.

Note 1: At 80 MHz and 800 MHz, the separation distance for the higher frequency range applies.

Note 2: The ISM (industrial, scientific and medical) bands between 150 kHz and 80 MHz are 6,765 MHz to 6,795 MHz; 13,553 MHz to 13,567 MHz; 26,957 MHz to 27,283 MHz; and 40,66 MHz to 40,70 MHz.

Note 3: An additional factor of 10/3 is used in calculating the recommended separation distance for transmitters in the ISM frequency bands between 150 kHz and 80 MHz and in the frequency range 80 MHz to 2.5 GHz to decrease the likelihood that mobile/portable communications equipment could cause interference if it is inadvertently brought into patient areas.

Note 4: These guidelines may not apply in all situations. Electromagnetic propagation is affected by absorption and reflection from structures, objects and people.

INDEX

Numerics

- 12-LEAD
 - Control, location of 2-13
- 12-lead ECG 3-5
 - About xi
 - Acquiring a 12-lead ECG 3-9
 - Cable 3-5
 - Data acquisition mode 3-12
 - Identifying sites 3-9
 - Limb lead electrode placement 3-10
 - Limb lead electrode sites 3-9
 - Override 3-12
 - Post-option 3-12
 - Precordial lead electrode sites 3-10
 - Pre-option 3-12
 - Procedure 3-11
 - Report, 3-channel format 3-13
 - Report, 4-channel format 3-14
 - Setup menu 9-9
- 3-lead cable 3-5
- 5-wire cable 3-5

A

- AC Power Adapter operation 7-5
- Accessories 8-14
- ADVISORY
 - Control, location of 2-3
 - Use in AED 4-4
- Advisory Mode (see AED)
- Advisory monitoring 4-11
- AED
 - About x
 - Configuration 4-4

- Contraindications x
- Electrodes off 4-8
- Indications for x
- Motion detected message 4-8
- Operator considerations x
- Procedure 4-4
- Setup menu 9-5
- Shock counter 4-9
- Therapy 4-4
- Troubleshooting tips 4-12
- AED Configuration 4-4
- AED Mode (see AED)
- AED procedure
 - Electrodes off 4-8
 - Motion detected 4-8
 - No shock advised 4-10
 - Shock advised 4-6
 - Shock counter 4-9
- Alarm event 6-6
- ALARMS
 - Control, location of 2-7
- Alarms
 - Adjusting volume in OPTIONS 2-9
 - Inservice Mode operation E-1
 - Limits 2-22
 - Managing 2-24
 - Quick Set 2-22
 - Setting 2-22
 - Setup menu 9-10
 - Silence 2-22
 - Silencing, preemptively 2-24
 - VF/VT Alarm 2-22
 - Wide or narrow limits 2-22

- American Heart Association
 - Prehospital recommendations xi
 - Surviving cardiac arrest x
- ANALYZE
 - Control, location of 2-5
- Anterior-lateral placement 3-4, 4-3, 5-7
- Anterior-posterior placement 4-3, 5-8
- Applying ECG electrodes 3-6
- Arterial (ART) 3-35
- AT Commands 9-19
- Automated External Defibrillation (see AED)

B

- Basic Orientation 2-1
- BATT CHG
 - Indicator, location of 2-5
- Batteries
 - About types of 2-25
 - Battery pins 2-25
 - Description 8-8
 - Inspection 2-28
 - Installing 2-28
 - Maintenance 8-8
 - NiCd battery performance 8-9
 - Receiving new 8-11
 - Recycling 8-11
 - Removing 2-28
 - Self-discharge rate 8-9
 - SLA Performance Factors 8-10

- Storing 8-11
- Temperature, battery
 - charging 8-9
- Voltage depression 8-9
- Battery charge (screen) 2-14
- Battery wells 2-18
- Bradycardia xi

C

- Cable connectors 2-10
- Cabrera format 3-13
- Canadian Standards
 - Association 1-5
- Cardiopulmonary Resuscitation (see CPR)
- Central venous (CVP) 3-35
- CHARGE
 - Control, location of 2-5
- Checklist, Operator's C-1
- Checks, function
 - Patient ECG cable 8-4
 - QUIK-COMBO cable
 - pacing 8-6
 - Standard paddles
 - synchronized
 - cardioversion 8-5
 - Therapy cable synchronized
 - cardioversion 8-6
- Cleaning 8-4
- Clock Setup menu 9-17
- CO2 exhaust 2-18
- CODE SUMMARY 2-8
 - Control, location of 2-13
 - Critical event record 6-3
 - Event/vital signs log 6-4
 - Preamble 6-4
 - Printing 6-3
 - Report 6-3
 - Report Formats 6-5
- Color coding for ECG leads 3-7
- Computerized ECG
 - analysis 3-14
- Connecting the patient ECG
 - cables 3-5
- CONTRAST
 - Control, location of 2-7
 - How to use 2-8
- Controls, indicators, and connectors 2-3
- CPR
 - Defibrillation therapy and x
 - Relation to CPSS D-1
- CPSS
 - Activate with ADVISORY control 2-5
 - Overview D-1
- CPSS event 6-6
- Critical Event Record 6-3
- CURRENT
 - Control, location of 2-6

D

- Data Management 6-1

- Data Retrieval 6-2
- Data storage 6-2
- Memory capacity 6-2
- Report Types 6-2
- Data retrieval 6-2
- Data storage 6-2
- Data/Fax Transmissions
 - Procedure 6-7
- Defibrillation Shock
 - Overlays 4-14
- Defibrillation Therapy
 - About x
 - Contraindications xi
 - Procedure for pediatric patients 5-8
- Deleting archived patient reports 6-18
- Device tracking ii
- Diagnostic frequency
 - response 6-10
- Direct Connection 6-24

E

- ECG
 - 12-lead cable 3-5
 - 12-lead procedures 3-11
 - 12-lead troubleshooting 3-15
 - 3-lead cable 3-5
 - 5-wire cable 3-5
 - Adjusting systole volume 3-4
 - Channels on screen 2-16
 - Connecting the ECG cable 3-5
 - Data acquisition mode 3-12
 - Electrode requirements 3-6
 - Inservice Mode operation E-1
 - Monitoring 3-2
 - Procedure 3-6
 - Troubleshooting 3-8
 - With paddles and paddles accessories 3-4, 3-5
 - Override 3-12
 - Precordial lead electrode sites 3-10
 - Precordial lead monitoring 3-6
 - Pre-option 3-12
 - Selecting lead and size 3-2
 - Size and QRS complexes 2-16
- ECG CONNECTOR
 - Location of 2-10
- ECG size (screen) 2-14
- Electrocardiography (see ECG)
- Electrodes
 - Placement 3-4, 4-3
 - Replacing and removing 5-5
- ENERGY SELECT
 - Control, location of 2-5
- EtCO2
 - (also see Monitoring EtCO2)
 - Cable connector 2-10
 - CO2 alarms 3-33
 - CO2 scale options 3-33
 - Contraindications xii
 - How capnography works 3-30

- Indications xiii
- Monitoring xiii
- Monitoring area on screen 2-15
- Monitoring procedure 3-32
- Monitoring waveform analysis 3-31
- Troubleshooting tips 3-34

EVENT

- Control, location of 2-7
- Screen overlay 2-7
- Event Log 2-8
- Event marker 1-6
- Event/vital signs log 6-4
- Events
 - Inservice Mode operation E-1
 - Monitoring 6-4
 - Operator initiated 6-4
 - Setup menu 9-9
 - Therapy 6-4
 - Defibrillation 6-4
 - Pacing 6-4
 - Transmission 6-4

F

- FAST-PATCH
 - Disconnecting defibrillation cable 5-5
 - Electrode placement 3-4, 4-3
 - Manual Mode overlay 4-14
- Fax Organization Setup
 - Menu 9-17
- Fax/Data Transmissions
 - Procedure 6-7
- Flush system 3-36
- Frequency response, Printer 6-10

G

- Gurney hooks
 - Location of 2-18

H

- Heart Rate Monitor 2-15
- Heart rate/pulse rate indicator 1-5
- HOME SCREEN
 - Control, location of 2-7
 - How to use 2-8
- How IP works 3-36
- How VS and ST work 3-40
- Hypoxemia xii

I

- Implanted Defibrillators, patients
 - with 3-5
- Implanted Pacemakers, patients
 - with 3-4
- Inservice Mode E-1
- Internal Defibrillation
 - Paddles 4-15, 5-9
- Internal pacemakers 3-7

- International Transmit
 - connections F-1, G-1
- Intracranial (ICP) 3-35
- Invasive Pressure 3-35, 3-36
- Invasive pressure
 - (also see Monitoring IP)
- IP
 - Troubleshooting tips 3-37, 3-38, 3-39
- IP Monitoring 3-37, 3-38, 3-39
- L**
- LEAD button 3-2
- Leads off messages 3-7
- Left arterial (LAP) 3-35
- Limb lead electrode
 - placement 3-6
- Limb lead electrode sites
 - 12-lead ECG 3-9
- Limb Leads 3-7
- Loading
 - 100 mm paper 2-12
 - 50 mm paper 2-12
- Long format, CODE
 - SUMMARY 6-5
- M**
- Maintaining the Equipment 8-1
- Maintenance and testing
 - schedule 8-2
- Managing archived patient
 - reports 6-11
- Managing current patient
 - reports 6-7
- Manual defibrillation
 - procedure 4-15
- Manual Mode
 - Defibrillation procedure 4-15
 - Entering passcode 4-14
 - Setup menu 9-4
 - Switching from AED 4-13
 - Troubleshooting tips 4-17
- Marquette 12SL ECG analysis
 - program xi
- Medium format, CODE
 - SUMMARY 6-5
- Memory capacity 6-2
- MODE, printer (frequency
 - response) 6-10
- Modes of Operation
 - Advisory Mode 4-4
 - AED 4-4
 - Inservice E-1
 - Manual Mode 4-13
 - Service Mode 9-18
 - Setup Mode 9-3
- Monitor frequency
 - response 6-10
- Monitoring 3-1
 - Advisory 4-11
 - Procedure 3-5
 - Special placement
 - situations 3-4
- Monitoring area
 - EtCO₂ 2-15
 - Heart rate 2-15
 - NIBP 2-15
 - Pulse rate 2-15
 - Screen 2-14
 - SpO₂ (pulse oximeter) 2-15
- Monitoring EtCO₂
 - CO₂ alarms 3-33
 - How capnography works 3-30
 - Procedure 3-32
 - Waveform analysis 3-31
- Monitoring Invasive Pressure
 - (IP) 3-35
- Monitoring IP 3-36
 - Considerations 3-36
 - Procedure 3-36
- Monitoring NIBP
 - Considerations 3-26
 - How NIBP works 3-25
 - Procedure 3-26
- Monitoring patients with internal
 - pacemakers 3-7
- Monitoring SpO₂
 - C-LOCK 3-22
 - Considerations 3-17
 - How a pulse oximeter
 - works 3-17
 - Masimo Procedure 3-20
 - Procedure (Masimo) 3-18
 - Procedure (Nellcor) 3-20
 - SpO₂ volume 3-19, 3-21
- Monitoring the ECG 3-2
 - Adjusting the systole
 - volume 3-4
- Monitoring VS and ST 3-39
 - Considerations 3-41
 - Procedure 3-41
- Monitoring, events 6-4
- Motion Detection D-2
- N**
- Nellcor oximeter sensor 3-21
- NIBP
 - (also see Monitoring NIBP)
 - Cable connector 2-10
 - Considerations 3-26
 - Contraindications xii
 - Cuff selection 3-26
 - How NIBP works 3-25
 - Indications xii
 - Monitoring xii
 - Monitoring area on
 - screen 2-15
 - Monitoring
 - considerations 3-26
 - Monitoring procedure 3-26
 - Troubleshooting tips 3-28
- Noninvasive Pacing 4-3
 - Therapy 4-18
 - Troubleshooting tips 4-20
- Noninvasive Pacing (see Pacing)
- O**
- ON
 - Control, location of 2-5
- Operator's Checklist C-1
- OPTIONS
 - How to use 2-20, 9-3
 - Screen overlay 2-9
- Options
 - 12-lead 2-13
- Overlay
 - Alarms 2-22
 - Channel 1 3-2, 3-3
 - HR 3-4
 - Manual Mode 4-13
 - Options 2-9, 2-20
 - Options/Patient 2-20
 - Setup passcode 9-3
 - SpO₂ 3-19, 3-21
- Override, ECG 3-12
- P**
- Pace arrow
 - Internal pacing 1-6
 - Noninvasive pacing 1-6
- PACER
 - Control, location of 2-6
- Pacing
 - About xi
 - Adjust current with CURRENT
 - Control 2-6
 - Demand and nondemand 4-19
 - Noninvasive 4-3
 - Noninvasive pacing
 - procedure 4-19
 - Setup menu 9-1, 9-7
 - Slow rate using PAUSE
 - control 2-6
 - Troubleshooting tips 4-20
- Pacing report 6-6
- Paddle Accessory Options 5-1
- Paper
 - Loading 100 mm 2-12
 - Loading 50 mm 2-12
- Passcode
 - Manual Mode 4-14
 - Set for Setup Mode 9-18
 - Setup mode 9-2
- Patient data, entering
 - Using OPTIONS 2-9
- Patient Reports 6-3
 - Accessing previous 2-9
 - Deleting archived patient
 - reports 6-18
 - Managing archived patient
 - reports 6-11
 - Managing current patient
 - reports 6-7
 - Printing a current patient
 - report 6-9
 - Printing archived patient
 - reports 6-15
 - Transmitting archived
 - reports 6-11

- Transmitting current patient report 6-7
- Patient Reports (see Data Management)
- PAUSE
 - Control, location of 2-6
- PC Card Cover 2-18
- Pediatric paddles 5-1, 5-6
 - Attaching 5-6
 - Cleaning 5-8
 - Defibrillation procedure 5-8
 - Placement 5-7
 - Removing 5-7
- Power Adapter
 - Cleaning 7-7
 - Comprehensive maintenance 7-7
 - Controls, indicators, and connectors 7-4
 - Fuse replacement 7-7
 - Mounting to defibrillator 7-6
 - Replacement parts and accessories 7-9
 - Troubleshooting 7-8
 - Unpacking and inspecting 7-3
 - Warranty 7-8
- Power Adapter Connector
 - About 2-19
 - Connecting 7-5
 - Control, location of 2-18
- Preamble, CODE
 - SUMMARY 6-4
- Precordial Leads 3-7
 - Electrode sites 3-10
 - Monitoring 3-6
- PRINT
 - Control, location of 2-13
- Print configurations before service or repair 9-2
- Print Defaults 9-18
- Printer
 - 100 mm 2-10
 - 50 mm 2-10
 - Controls, location of 2-13
 - Loading 100 mm paper 2-12
 - Loading 50 mm paper 2-12
 - Setup menu 9-10
- Printer frequency response 6-10
- Printer MODE (frequency response) 6-10
- Printing
 - archived patient reports 6-15
 - Auto Print Setup menu 9-11
 - Current patient report 6-9
 - Starting 2-13
 - Stopping 2-13
- Printing a CODE SUMMARY report 6-3
- Printing a current patient report 6-9
- Printing archived patient reports 6-15
- Pulse Oximeter Sensors 3-20

- Q**
- QRS complex 3-7, 4-19
- QRS detection 2-15
- Quick Set (alarms)
 - Alarms
 - Setting 2-22
- QUIK-COMBO
 - Manual Mode overlay 4-14
 - Using when pacing 4-18
- QUIK-COMBO Electrodes 5-3
 - Connecting to therapy cable 5-4
 - Electrode placement 4-3
 - Removing electrodes 5-5
 - Replacing electrodes 5-5
- QUIK-COMBO electrodes
 - Electrode placement 3-4, 4-3
- R**
- Rate
 - Control, location of 2-6
- Recycling Information
 - Batteries 8-11
 - Device 8-14
- Report Types 6-2
- Reports (see Data Management)
- Reset Defaults Setup menu 9-17
- Responsibility for information ii
- Resuscitation (see CPR)
- R-wave sense marker 1-6
- S**
- Safety
 - Information 1-1
 - Symbols 1-3
 - Terms 1-2
- SAS
 - Activate with ANALYZE control 2-5
 - Algorithm requirements 4-4
 - Electrode contact impedance D-1
 - How SAS operates D-1
 - Overview D-1
 - When recommends shock D-1
- SAS event 6-6
- Screen
 - Alarms 2-14
 - Battery charge 2-14
 - ECG size display 2-14
 - Messages B-1
 - Monitoring alarms 2-14
 - Monitoring parameters 2-14
 - Selected energy 2-14
 - Selecting waveform channels 2-16
 - Status message area 2-14
 - Time display 2-14
 - VF/VT Alarm display
 - Warning messages 2-14
 - Waveform channel areas 2-14, 2-15, 2-16
- Screen Overlay (see Overlay)

- Selected energy (screen) 2-14
- SELECTOR
 - Control, location of 2-7
 - How to use 2-8
 - Knob, using the 3-2, 3-3, 3-4, 3-21, 4-14, 4-15, 4-19, 5-8, E-2
- Send Configuration Setup menu 9-18
- SERVICE
 - Indicator, location of 2-5
- Service and Repair 8-13
- Setup Configuration
 - Printing before service or repair 9-2
- Setup Menus
 - 12-Lead 9-9
 - Advisory Mode 9-5
 - Alarms 9-10
 - Auto Print 9-11
 - Clock 9-17
 - External Modem 9-14, 9-17
 - General 9-3
 - Internal Modem 9-13, 9-16
 - Manual Mode 9-4
 - Organization 9-17
 - Pacing 9-1, 9-7
 - Printer 9-10
 - Reset Defaults 9-17
 - Send Config 9-18
 - Set Passcode (Setup) 9-18
 - Transmission 9-11
 - Transmission/Data 9-11
 - Transmission/Data/
 - Default 9-12, 9-13
 - Transmission/Data/Ports 9-13
 - Transmission/Data/Ports/
 - Direct Connect 9-14
 - Transmission/Data/Ports/
 - External 9-14
 - Transmission/Data/Ports/
 - External Cell 9-14
 - Transmission/Data/Ports/
 - Internal 9-13
 - Transmission/Data/Ports/
 - Internal Cell 9-13
 - Transmission/Data/Sites 9-12
 - Transmission/Data/Sites/Site 1 9-12
 - Transmission/Fax 9-14
 - Transmission/Fax/Default 9-15
 - Transmission/Fax/Ports 9-16
 - Transmission/Fax/Ports/
 - Internal Cell Fax 9-16
 - Transmission/Fax/Ports/
 - Internal Fax 9-16
 - Transmission/Fax/Sites 9-15
 - Transmission/Fax/Sites/Site 1 9-15
- Setup Mode Passcode 9-18
- Setup Options 9-1, 9-2
 - Entering 9-3

- SHOCK
 - Control and Indicator, location of 2-5
 - Indicator, using the 4-14, D-2
- Shock counter 4-9
- Shock report 6-6
- Short format, CODE
 - SUMMARY 6-5
- SIZE button 3-3
- Speaker, location of 2-10
- SPEED DIAL
 - Using the 3-19
- SpO2
 - (also see Monitoring SpO2)
 - Adjusting pulse tone
 - volume 3-19, 3-21
 - Cable connector 2-10
 - C-LOCK 3-22
 - Contraindications xii
 - How a pulse oximeter works 3-17
 - Inservice Mode operation E-1
 - Monitoring xii, 3-16
 - Monitoring area on screen 2-15
 - Monitoring
 - considerations 3-18
 - Monitoring procedure 3-18, 3-20
 - Pulse Oximeter sensors 3-20
 - Troubleshooting tips 3-22
- SpO2 Connector
 - Connecting a cable 3-19, 3-20
 - Location of 2-10
- Standard Paddles
 - Features 2-19
 - Manual Mode overlay 4-15
 - Placement 3-4, 4-3
 - User Test 8-3
 - Wells 2-18
- Status messages (screen) 2-14
- Sterilizable Internal Defibrillation Paddles 5-9
- Sternum paddle 3-4
- Storing batteries 8-11
- Supplies, accessories, and training tools 8-14
- Switching from AED to manual mode 4-13
- SYNC
 - Control, location of 2-5
- Synchronized Cardioversion 4-3
 - Procedure 4-16
 - Troubleshooting tips 4-17
- System Connector
 - Location of 2-18
- System connector, transmitting using 6-24
- T**
 - Telephone number/prefix, entering 9-19
 - Test Load 8-3, 8-4, C-1
 - Testing 5-6
 - Checklist C-1
 - Schedule 8-2
 - User 8-3
 - Testing, user 8-3
 - Text conventions xiv
 - Therapy 4-1
 - Defibrillation 4-3
 - Electrode and standard paddle placement 4-3
 - Noninvasive pacing 4-3
 - Synchronized cardioversion 4-3
 - Therapy cable
 - Connecting 2-11
 - Disconnecting 2-11
 - Therapy Connector
 - Connecting electrodes to 4-15, 4-16
 - Location of 2-10
 - Message if no connection 4-9
 - Time (screen) 2-14
 - Training Tools 8-14
 - Transducer 3-35, 3-36
 - Transmission Setup menu 9-11
 - Transmission/Data
 - Default Setup menu 9-12, 9-13
 - Ports Setup menu 9-13
 - Ports/Direct Connect Setup menu 9-14
 - Setup menu 9-11
 - Sites Setup menu 9-12
 - Sites/Site 1 Setup menu 9-12
 - Transmission/Fax
 - Default Setup menu 9-15
 - Ports Setup menu 9-16
 - Setup menu 9-14
 - Sites Setup menu 9-15
 - Sites/Site 1 Setup menu 9-15
- TRANSMIT
 - Control, location of 2-13
- Transmit Connections
 - Internal Cellular 6-20, 6-22, 6-23, F-1
- Transmit connections
 - International F-1
- Transmit connections, International G-1
- Transmit sites, setting up 9-19
- Transmitting
 - Archived patient reports 6-11
 - Current patient report 6-7
 - Direct Connection 6-24
 - Equipment connections with System Connector 6-24
 - External Modem Setup menu 9-14, 9-17
 - Fax Organization Setup menu 9-17
 - From External modem, landline 6-23
 - From PC Card modem, cellular 6-21, F-1
 - From PC Card modem, landline 6-22
 - From System Connector, direct connect 6-24
 - From the PC Card modem 6-20
 - From the system connector 6-24
 - Internal Modem Setup menu 9-13, 9-16
 - Setting up transmit sites 9-19
 - Treatment protocol 6-24
 - Transmitting archived reports 6-11
 - Transmitting current patient report 6-7
- Trending
 - (see Monitoring VS and ST)
- Troubleshooting tips
 - 12-lead ECG 3-15
 - Data Management 6-26
 - Defibrillation and synchronized cardioversion 4-17
 - ECG monitoring 3-8
 - EtCO2 3-34
 - General 8-12
 - IP 3-37, 3-38, 3-39
 - Modem data transfer 6-26
 - NIBP 3-28
 - Noninvasive pacing 4-20
 - SpO2 3-23
- U**
 - Unpacking and inspecting 2-3
 - User Controls 2-7
 - User test, how to activate 2-9
 - User testing 8-3
- V**
 - VF/VT Alarm
 - On screen 2-14
 - Turning on and off 2-23
 - Vital signs
 - (also see Monitoring VS and ST)
- W**
 - Warranty 8-14
 - Waveform
 - Alarm event 6-6
 - CPSS event 6-6
 - Events, examples of 6-6
 - Pacing report 6-6
 - SAS event 6-6
 - Shock report 6-6
 - Waveform channel (screen) 2-14
 - Waveform channel areas 2-15, 2-16
 - Waveforms
 - Events 6-5
 - Selecting channels 2-16

Index

When to use
Monitoring IP 3-35

Z
Zero reference 3-36



Physio-Control, Inc.
11811 Willows Road NE
Redmond, WA 98052 USA
Telephone: 425.867.4000
Toll Free (USA only): 800.442.1142
Fax: 425.867.4121
www.physio-control.com